

PHCbi

Operating Instructions

Cooled Incubator

MIR-154

MIR-254 Series



MIR-154

Please read the operating instructions carefully before using this product, and keep the operating instructions for future use.

See page 61 for model number.

CONTENTS

INTRODUCTION	3
PRECAUTIONS FOR SAFE OPERATION	4
ENVIRONMENTAL CONDITIONS	9
INCUBATOR COMPONENTS	10
Control panel.....	12
Switch box.....	13
INSTALLATION SITE	14
INSTALLATION	15
TOP SCREEN	16
FUNCTIONS THROUGH CONTROL PANEL	17
STANBY OPERATION (MENU/Std-by).....	17
SETTING OF KEY LOCK (MENU/Std-by).....	18
Setting of key lock (Key Lock).....	18
Setting of key unlock (Key Unlock)	18
PROCEDURES OF SETTING VALUE.....	19
Setting of Chamber Temperature.....	19
Setting of Key Lock	20
HIGH LIMIT/LOW LIMIT ALARM (MENU/Std-by)	21
PROGRAMMING (MENU/Edit)	22
EDIT OF SAVED PROGRAM (MENU/Edit)	28
START OF PROGRAM (MENU/Run).....	29
JOIN FUNCTION	31
SKIP OF STEP (MENU/Skip)	32
STOP OF PROGRAM (MENU/Stop).....	33
AUTOMATIC DEFROST (MENU/Tools/Date Time).....	34
MANUAL DEFROST (MENU/M.def)	35
VARIOUS SETTING (MENU/Tools).....	36
Display of log (Tools/Log)	36
Setting of date, time, log (Tools/Date Time).....	39
Alarm setting (Tools/Alarm, Opt., Low Humi. Setting)	40
Key lock password setting (Tools/Key Lock PW Setting)	41
Default setting (Tools/Default Setting)	42
Delete of program (Tools/Delete User Data).....	43
ADJUSTMENT OF SHELVES.....	45
ALARMS AND SAFETY FUNCTIONS	46
MAINTENANCE	49
Cleaning.....	49
Cleaning of evaporating tray.....	49
Replacement of lamp.....	50
Replacement of glow starter	50

CONTENTS

TROUBLESHOOTING	51
DISPOSAL OF UNIT	52
LOW HUMIDITY MODE	57
LOW COMPRESSOR VIBRATION DESIGN	58
PERFORMANCE DATA	59
SPECIFICATIONS.....	60
PERFORMANCE.....	61
SAFETY CHECK SHEET	62

INTRODUCTION

- Read the operating instructions carefully before using the Product and follow the instructions for safety operation.
- PHC Corporation disavows any responsibility for safety if the Product is used for other than the intended use or used with any procedures other than those given in the operating instructions.
- Keep the operating instructions in a suitable place so that it can be referred to as necessary.
- The contents of the operating instructions are subject to change without notice for improvement of performance or functions.
- Contact our sales representative or agent if any page of the operating instructions is lost or the page order is incorrect.
- Contact our sales representative or agent if any point in the operating instructions is unclear or if there are any inaccuracies.
- No part of the operating instructions may be reproduced in any form without the expressed written permission of PHC Corporation.

IMPORTANT NOTICE

PHC Corporation guarantees this product under certain warranty conditions. However, please note that PHC Corporation shall not be responsible for any loss or damage to the contents of the product.

<Intended Use>

This product is a laboratory equipment intended to carry out bacteria test, food abuse test, constant-temperature test, and culture of microorganism, etc.

PRECAUTIONS FOR SAFE OPERATION

It is imperative that the user complies with the operating instructions as it contains important safety advice.

Items and procedures are described so that you can use this unit correctly and safely. If the precautions advised are followed, this will prevent possible injury to the user and any other person.

Precautions are illustrated in the following way:



WARNING

Failure to observe WARNING signs could result in a hazard to personnel possibly resulting in serious injury or death.



CAUTION

Failure to observe CAUTION signs could result in injury to personnel and damage to the unit and associated property.

Symbol shows;

-  This symbol means caution.
-  This symbol means an action is prohibited.
-  This symbol means an instruction must be followed.

Be sure to keep the operating instructions in a place accessible to users of this unit.

- < Label on the unit >
-  This mark is labeled on the cover in which the electrical components of high voltage are enclosed to prevent the electric shock. The cover should be removed by a qualified engineer or service personnel only.
 -  This symbol indicates a hot surface.

USA Only: This product has a fluorescent lamp that contains mercury. Disposal may be regulated in your community due to environmental considerations. For disposal or information, please visit PHC website: <https://www.phchd.com>.

Contains mercury / Contenu avec mercure

For more information on safe handling procedures, the measures to be taken in case of accidental breakage and safe disposal options visit:

ec.gc.ca/mercure-mercury/.

Dispose of or recycle in accordance with applicable laws.

Pour plus de renseignements sur les procédures de manutention sécuritaire, les mesures à prendre en cas de bris accidentel et les options d'élimination sécuritaire visitez:

ec.gc.ca/mercure-mercury/.















Mettez au rebut ou recyclez conformément aux lois applicables.

For the State of California, USA Only:















This product contains a CR Coin Cell Lithium Battery which contains Perchlorate Material – special handling may apply. See www.dtsc.ca.gov/hazardouswaste/perchlorate.

PRECAUTIONS FOR SAFE OPERATION

WARNING







-  **Do not use the unit outdoors.** Current leakage or electric shock may result if the unit is exposed to rain water.
-  **Only qualified engineers or service personnel should install the unit.** The installation by unqualified personnel may cause electric shock or fire.
-  **Install the unit on a sturdy floor and take an adequate precaution to prevent the unit from turning over.** If the floor is not strong enough or the installation site is not adequate, this may result in injury from the unit falling or tipping over.
-  **Never install the unit in a humid place or a place where it is likely to be splashed by water.** Deterioration of the insulation may result which could cause current leakage or electric shock.
-  **Never install the unit in a flammable or volatile location.** This may cause explosion or fire.
-  **Never install the unit where acid or corrosive gases are present** as current leakage or electric shock may result due to corrosion.
-  **Always ground (earth) the unit to prevent electric shock.** If the power supply outlet is not grounded, it will be necessary to install a ground by qualified engineers.
-  **Never ground the unit through a gas pipe, water main, telephone line or lightning rod.** Such grounding may cause electric shock in the case of an incomplete circuit.
-  **Connect the unit to a power source as indicated on the rating label attached to the unit.** Use of any other voltage or frequency other than that on the rating label may cause fire or electric shock.
-  **Never store volatile or flammable substances** in this unit if the container cannot be sealed. These may cause explosion or fire.
-  **Do not insert metal objects such as a pin or a wire into any vent, gap or any outlet on the unit.** This may cause electric shock or injury by accidental contact with moving parts.
-  **Use this unit in safe area when treating the poison, harmful or radiate articles.** Improper use may cause bad effect on your health or environment.
-  **Turn off the power switch (if provided) and disconnect the power supply to the unit prior to any repair or maintenance** of the unit in order to prevent electric shock or injury.
-  **Do not touch any electrical parts (such as power supply plug) or operate switches with a wet hand.** This may cause electric shock.

WARNING

-  **Ensure you do not inhale or consume medication or aerosols** from around the unit at the time of maintenance. These may be harmful to your health.
-  **Never splash water directly onto the unit** as this may cause electric shock or short circuit.
-  **Never put containers with liquid on the unit** as this may cause electric shock or short circuit when the liquid is spilled.
-  **Never bind, process, or step on the power supply cord, or never damage or break the power supply plug.** A broken power supply cord or plug may cause fire or electric shock.
-  **Do not use the power supply cord if its power supply plug is loose.** Such power supply cord may cause fire or electric shock.
-  **Never disassemble, repair, or modify the unit yourself.** Any such work carried out by an unauthorized person may result in fire, or electric shock or injury due to a malfunction.
-  **Disconnect the power supply plug if there is something wrong with the unit.** Continued abnormal operation may cause electric shock or fire.
-  **When removing the power supply plug from the power supply outlet, grip the power supply plug, not the cord.** Pulling the power supply cord may result in electric shock or fire by short circuit.
-  **Disconnect the power supply plug** before moving the unit. Take care not to damage the power supply cord. A damaged power supply cord may cause electric shock or fire.
-  **Disconnect the power supply plug when the unit is not used for long periods.** Keeping the connection may cause electric shock, current leakage, or fire due to the deterioration of insulation.
-  If the unit is to be stored unused in an unsupervised area for an extended period, **ensure that children do not have access and that doors cannot be closed completely.**
-  **The disposal of the unit should be accomplished by appropriate personnel.** Remove doors to prevent accidents such as suffocation.
-  **Do not put the packing plastic bag within reach of children** as suffocation may result.
-  **Do not position this unit and the other unit so that it is difficult to operate the disconnection of the power supply plug.** Failure to disconnect the power supply plug may cause fire if there is something wrong with the unit.

PRECAUTIONS FOR SAFE OPERATION

CAUTION

-  This unit must be plugged into a dedicated circuit protected by branch circuit breaker.
-  Use a dedicated power source as indicated on the rating label attached to the unit. A multiple-tap may cause fire resulting from abnormal heating.
-  **Never store corrosive substances such as acid or alkali** in this unit if the container cannot be sealed. These may cause corrosion of inner components or electric parts.
-  **Check the setting when starting up of operation after power failure or turning off of power switch.** The stored items may be damaged due to the change of setting.
-  **Be careful not to tip over the unit** during movement to prevent damage or injury.
-  **Prepare a safety check sheet** (copy the last page) when you request any repair or maintenance for the safety of service personnel.

ENVIRONMENTAL CONDITIONS

This equipment is designed to be safe at least under the following conditions (based on the IEC 61010-1):

- Indoor use;
- Altitude up to 2000 m;
- Temperature 5°C to 40°C;
- Maximum relative humidity 80% for temperature up to 31°C decreasing linearly to 50% relative humidity at 40°C;
- Mains supply voltage fluctuations up to $\pm 10\%$ of the nominal voltage;
- Transient overvoltages up to the levels of OVERVOLTAGE CATEGORY II;
- Temporary OVERVOLTAGES occurring on the mains supply;
- Applicable pollution degree of the intended environment (POLLUTION DEGREE 2 in most cases);

INCUBATOR COMPONENTS

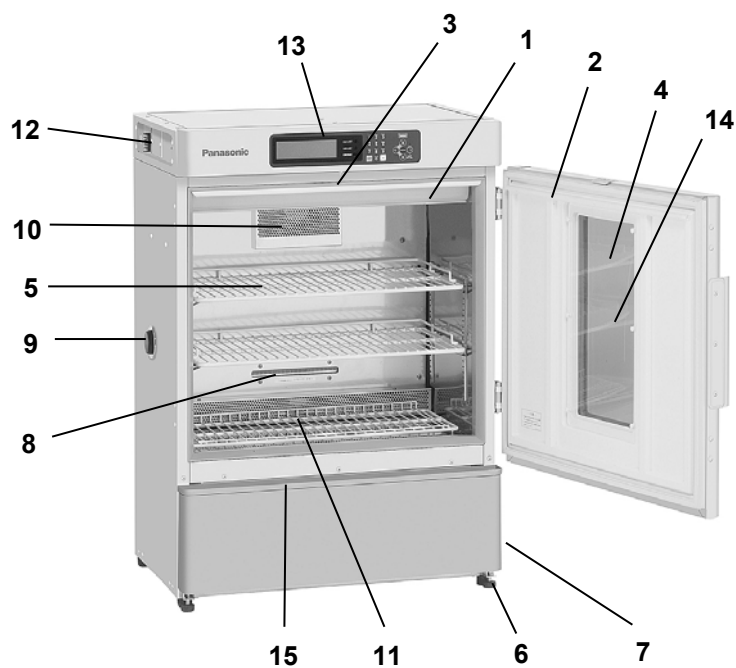

MIR-154

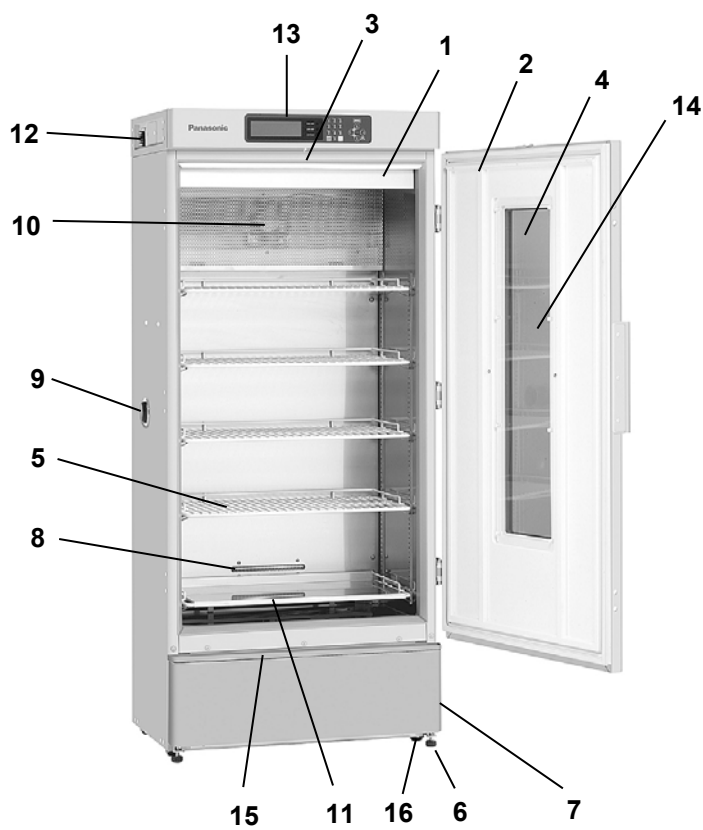

MIR-254

1. Shade: To protect the fluorescent lamp.

2. Door: The door can be opened to 130 degrees approx. The door is sealed securely to the cabinet by the magnetic gasket when it is closed.

Condensation may occur at the inner side of the door when a lot of damp material stored.

3. Door switch: To prevent the air from escaping by stopping the air circulating fan when the door is opened.

4. Glass window: 3-layer heat-absorbing glass to shut out the heat.

5. Shelf: The location (height) is adjustable according to the item size to be stored.

In case of MIR-254, do not change the position of the lowest shelf or do not remove the stainless panel on the lowest shelf to keep original airflow inside the chamber.

6. Leveling foot: Use these bolts to adjust the height and level the unit for installation.

7. Evaporating tray: The drained water resulting from the defrosting is accumulated and evaporated automatically in this tray. (Page 49)

8. Frost check opening: Check the frost on the condenser through this opening.

9. Access port: This port allows cables to be passed into the cabinet.

Note:

Be sure to set the rubber stopping to the hole for measurement (placed at the left side) as it was when passing cables for measurement and power cords through it.

Be sure to replace the cap after take out cable or, the inside temperature cannot complete down, and frost may accumulate outside the port surroundings.

10. Air circulating fan: Fan is installed inside the duct. Do not insert anything into the duct.

11. Drain port: Use this port when the chamber is washed with water. Always cover the port with cap when no use.

12. Switch box: Power switch, remote alarm terminals, and glow starter are placed.

13. Control panel: Temperature control, alarm setting, program setting are available through the control panel. The temperature indicator is attached on the control panel.

14. Glass protective plate: This is prevented from glass cracking. Use shading glass protective plate (sold separately) (MIR-154BP/254BP) when shading the window for observation.

15. Dew saucer: To hold the dew that adhere to inside of the door.

16. Caster (MIR-254 only): To facilitate the moving of the cabinet.

Note:

As for the unique features of this product, reducing compressor vibration and reversible door fitting, please contact our sales representative or agent.

When MIR-154's are stacked, the compressor vibration reduction is not available for both units.

INCUBATOR COMPONENTS

Control panel

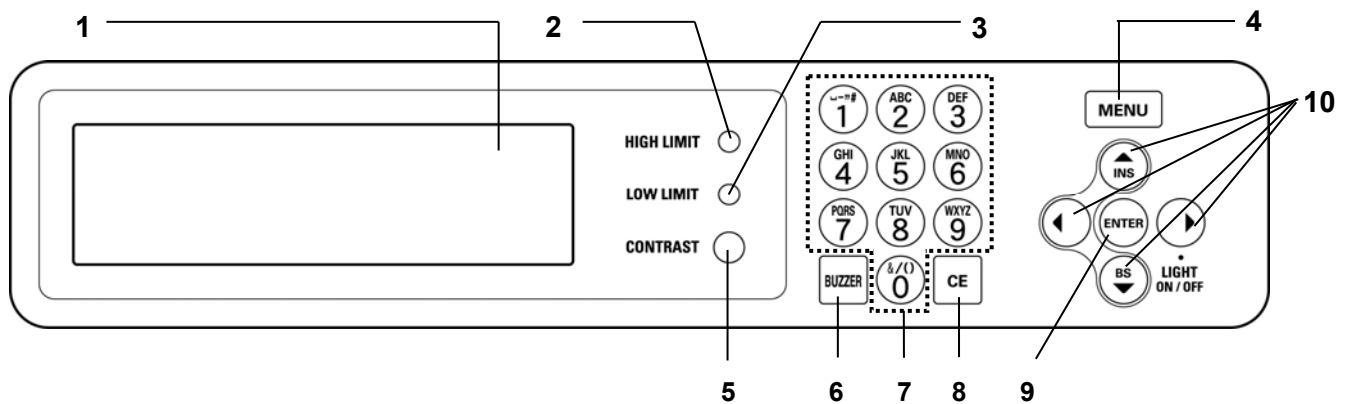

1. LCD panel

2. High limit temperature alarm volume (HIGH LIMIT)

To set the temperature of high limit temperature alarm.

3. Low limit temperature alarm volume (LOW LIMIT)

To set the temperature of low limit temperature alarm.

4. Menu button (MENU)

To open the menu window.

5. LCD contrast adjusting knob

To adjust the contrast of graphic LCD.

6. Alarm buzzer stop key (BUZZER)

To silence the alarm buzzer temporarily.

7. Character input key

8. Clear key (CE)

To clear the input value during editing of program.

9. Enter key (ENTER)

To determine the selection of menu. In program editing, pressing this key causes moving to a next article.

10. Shift key (Upward, downward, rightward, leftward)

Upward: To move the cursor upward. (When inputting a program name: Space key)

Downward: To move the cursor downward. (When inputting a program name: BackSpace key)

Leftward: To move the cursor leftward.

Rightward: To move the cursor rightward. (When displaying the top screen: fluorescent lamp ON/OFF.)

Switch box

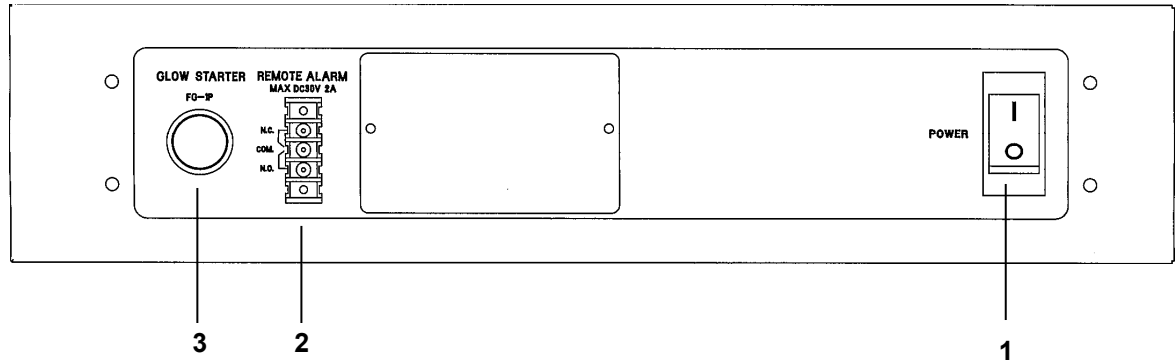

1. Power switch (POWER)

The switch for ON/OFF of all power source including the plug outlet.

2. Remote alarm terminals

Alarm signal can be drawn out via the contact output. Permissible contact capacity : DC 30 V, 2 A

- a) Contact output: Connect the lead wires to COM and NO terminals.
(Normal condition: open. Abnormal condition: close.)
- b) Contact output: Connect the lead wires to COM and NC terminals.
(Normal condition: close. Abnormal condition: open.)

COM and NO terminals are closed at the failure of electricity supply.

3. Glow starter (Product number: FG-1P)

INSTALLATION SITE

To operate this unit properly and to obtain maximum performance, install the unit in a location with the following conditions:

■ **A location not subjected to direct sunlight**

Do not install the unit under direct sunlight. Installation in a location subjected to direct sunlight cannot obtain the intended performance.

■ **A location with adequate ventilation**

Leave at least 10 cm around the unit for ventilation. Poor ventilation will result in a reduction of the performance and consequently the failure.

■ **A location away from heat generating sources**

Avoid installing the unit near heat-emitting appliances such as a heater or a boiler etc. Heat can decrease the intended performance of the unit.

■ **A location with little temperature change**

Install the unit under stable ambient temperature. The allowable ambient temperature is between +5 °C and +35 °C.

Note: This incubator changes to PID control when the temperature setting is about 7 °C higher than the ambient temperature. Under PID control, the temperature cycle is very small. For other temperature setting, the incubator is operated with ON-OFF control, which temperature cycle is about 3 °C. At the beginning of operation or when the ambient temperature is fairly high, the cabinet side may heat up. However, this does not denote a malfunction. It is due to the hot gas piped around the unit frame to prevent condensation around the cabinet.

■ **A location with a sturdy and level floor**

Always install the unit on a sturdy and level floor. The uneven floor or tilted installation may cause failure or injury. Install the unit in stable condition to avoid the vibration or noise. Unstable condition may cause vibration or noise.

 **WARNING**

Install the unit on a sturdy floor. If the floor is not strong enough or the installation site is not adequate, this may result in injury from the unit falling or tipping over.

Select a level and sturdy floor for installation. This precaution will prevent the unit from tipping. Improper installation may result in water spillage or injury from the unit tipping over.

■ **A location not prone to high humidity**

Install the unit in the ambient of 80% R.H. or less humidity. Installation under high humidity may cause current leakage or electric shock.

 **WARNING**

Do not use the unit outdoors. Current leakage or electric shock may result if the unit is exposed to rain water.

Never install the unit in a humid place or a place where it is likely to be splashed by water. Deterioration of the insulation may result which could cause current leakage or electric shock.

■ **A location without flammable or corrosive gas**

Never install the unit in a flammable or volatile location. This may cause explosion or fire or may result in the current leakage or electric shock by the corrosion of the electrical components.

⚠ CAUTION

Do not install it on the place (near the drain facilities etc.) where the corrosion cause material like the sulfur compound etc. might be generated. The refrigeration unit is deteriorated, and it causes the breakdown of the product due to the corrosion of the copper pipe.

■ A location where nothing falls on

Do not install the product where things might fall on it. The product might be damaged, and it causes a breakdown.

INSTALLATION

1. Remove the packaging materials and tapes

Remove all transportation packaging materials and tapes. Open the doors and ventilate the unit. If the outside panels are dirty, clean them with a diluted neutral dishwashing detergent. (Undiluted detergent can damage the plastic components. For the dilution, refer to the instruction of the detergent.) After the cleaning with the diluted detergent, always wipe it off with a wet cloth. Then wipe off the panels with a dry cloth.

Note:

Remove the cable tie banding the power supply cord. Prolonged banding may cause the corrosion of the cord coating.

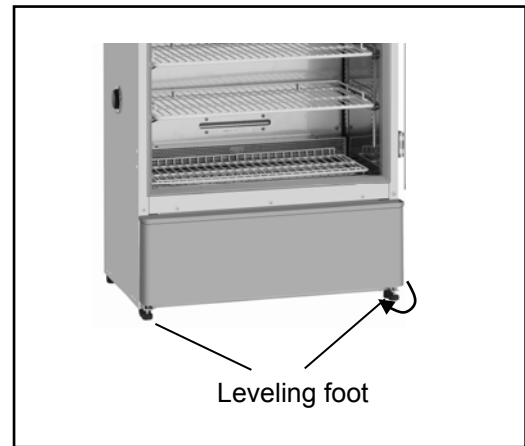

2. Adjust the leveling foot

Extend the leveling feet by rotating them counterclockwise to contact them to the floor. Ensure the unit is level.

3. Ground (earth)

⚠ WARNING

Use a power supply outlet with ground (earth) to prevent electric shock. If the power supply outlet is not grounded, it is necessary to install a ground by qualified engineers.

Never ground the unit through a gas pipe, water main, telephone line or lightning rod. Such grounding may cause electric shock in the case of an incomplete circuit.

Note:

The chamber temperature may deviate from the set temperature when the unit is running with the heater or motor energized.

TOP SCREEN

The top screen below is displayed when turning on the power switch. The default temp. is 25.0 °C. The date and time are preset at the factory. Refer to page 39 when more accurate setting is needed.

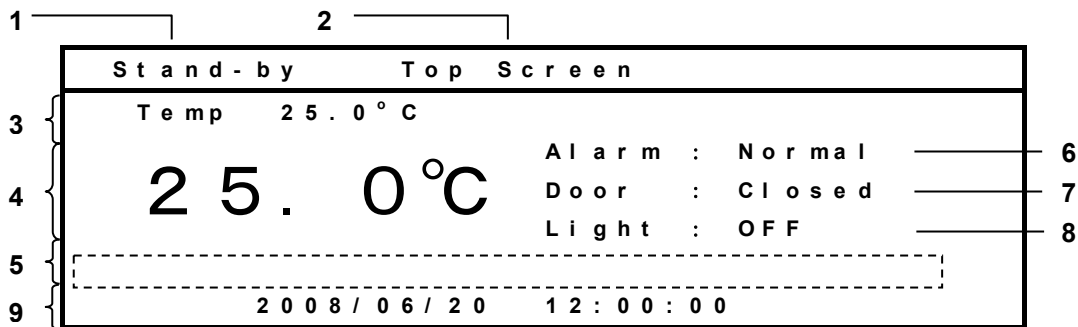

1. Display of running status

The current running status is displayed. At the power-on, "stand-by" is displayed and the system runs continuously under the stand-by running condition (refer to page 17). When turning on power for the first time, the system runs continuously under the initial setting condition.

"Running" is displayed at the time of programmed running. "Defrosting" is displayed while removing frost.

2. Display of program name

A program name under operation is displayed. "Top Screen" is displayed during standby operation.

3. Display of setting

Set value of temperature is displayed.

4. Display of current value

Current value of temperature is displayed.

5. Message display field

A message is displayed when a breakdown occurs.

6. Alarm display(Alarm)

"Alarm" is alternately displayed by reversed/non-reversed character while alarm is operating.

"Warning" is alternately displayed by reversed/non-reversed character at the time of warning.

"Normal" is displayed at a normal condition.

An adding message is displayed in the message display field.

7. Display of door status

"Door" is highlighted when the door is open. "Closed" is displayed when the door is closed.

8. Lighting display (Light)

"ON" is displayed in outline type when the lighting has been turned on. "OFF" is displayed when turned off.

When the lighting is set to be turned on, the system is programmed running, "Program_ON" is displayed in outline type when the lighting has been turned on and "Program_OFF" is displayed in outline type when the lighting has been turned off.

9. Display of date and time

The current date and time is displayed.

FUNCTIONS THROUGH CONTROL PANEL

The following functions are available through control panel:

- **Setting of standby operation:** To set a running condition at the start-up or completion of programmed running. (refer to page 17)
- **Programming and edit:** To set a new program (page 22), or to edit (page 28), or delete (page 43) an user program.
- **Programmed running:** To start (page 29), skip (page 32) or stop (page 33) a programmed running.
- **Setting of defrost:** To set the automatic defrost (page 34) and to start the manual defrost. (page 35)
- **Setting of log cycle and sending to PC:** To set a log cycle of running data and to send a running log to PC. (page 38)
- **Setting of date and time:** To set the date and time shown on the top screen. (page 39)
- **Setting of alarm:** To set temperature alarm (page 40) and a high limit (or low limit) temperature alarm. (page 21)
- **Setting for optional component:** To set when an optional component is installed. (page 40)
- **Setting of low humidity mode:** To set the running for low humidity. (page 40)
- **Default setting:** To set the default for LCD panel and communication (DAQ) speed etc. (page 42)

STANDBY OPERATION (MENU/Std-by)

This product automatically operates with standby operation setting.

1. With the top screen displayed, press the menu button (MENU) to show the menu window. Select "Std-by" and press the enter key (ENTER).

Stand-by Top Screen		MENU
Temp 25.0°C	Alarm : Nor	Run
25.0°C	Door : Clo	Std-by
	Light : OFF	Edit
		Tools
2008/06/20	12:00:00	M. Def

2. Stand-by Setting screen is displayed. Set each parameter.

Stand-by Setting	
Temperature	25.0 °C (-10.0°C - +60.0°C)
Light Step	0LS (0.OFF 1.ON)
Key Lock	0 (0.UnLock 1.Lock)
High Limit	65°C
Low Limit	-15°C

3. Press the menu button (MENU) at the completion of parameter setting. The menu window is shown. Select "OK" and press the enter key (ENTER). The parameter is memorized.

The settable range of each parameter:

- Temperature:-10°C~+60°C

STANDBY OPERATION (MENU/Std-by)

■ Light step: 1 (ON) or 0 (OFF). In the case of selecting 0 (OFF), by pressing rightward shift key, lighting is turned on or off when the top screen is displayed.

(While the program operates, on/off of lighting depends on the program.)

*The lighting is available just under the specified setting range of temperature between +2 °C and +50 °C when the optional light add on kit (MIR-L15) is installed.

■ Key Lock: When selecting 1 (Lock), it is not possible to change any parameter. To unlock, it is required to input the key lock password.

Refer the next for the details.

SETTING OF KEY LOCK (MENU/Std-by)

Setting of Key Lock (Key Lock)

1. When setting of key lock, change the value of the key lock line from “0” to “1” in the stand-by setting screen (Stand-by Setting) and press the enter key (ENTER). The buzzer rings for a short while, and then the key is locked.

Stand-by Setting	
Temperature	25.0 °C (-10.0 °C - +60.0 °C)
Light Step	0 LS (0. OFF 1. ON)
Key Lock	1 (0. UnLock 1. Lock)
High Limit	65 °C
Low Limit	-15 °C

2. The other settings except key lock cannot be changed.

Setting of Key Unlock (Key Unlock)

1. When setting of key unlock, change the value of the key lock line from “1” to “0” in the stand-by setting screen (Stand-by Setting) and press the enter key (ENTER).

Stand-by Setting	Key Lock
Temperature	25.0 °C (-10.0 °C - +60.0 °C)
Light Step	0 LS (0. OFF 1. ON)
Key Lock	0 (0. UnLock 1. Lock)
High Limit	65 °C
Low Limit	-15 °C

2. Input password of 4 digits to the password field (Password) where the cursor is moved to, and press the enter key (ENTER). When setting of key unlock, the buzzer rings for a short while, and then “Key Lock” disappears in the stand-by setting screen (Stand-by Setting).

Stand-by Setting	Key Lock
Temperature	25.0 °C (-10.0 °C - +60.0 °C)
Light Step	0 LS (0. OFF 1. ON)
Key Lock	0 Password ****
High Limit	65 °C
Low Limit	-15 °C

Caution:

The buzzer rings for a long time when a wrong password is input. Input a correct password.
 The password for key unlock must be shared and administered by all users on this product.
 The setting of key unlock when shipped from the factory is "0000".
 Refer to page 41 for changing the password.

PROCEDURES OF SETTING VALUE

Setting of Chamber Temperature

Procedures of changing chamber temperature from 25 °C to -10 °C are shown below. As for other values, the same procedures are applied.

Procedures of changing chamber temperature from 25 °C to -10 °C

	Operation	Key	LCD Display			
1		----	Top screen is displayed.			
2	Press the menu button (MENU).	MENU	MENU window is displayed.			
3	Select Std-by in MENU window pressing the shift key (downward).	▼	Std-by is displayed in white letters.			
4	Press the enter key (ENTER).	ENTER	Stand-by Setting screen is displayed and chamber temperature setting value is changed into white letters.			
5	Change the value from 25.0 to 10.0 pressing the character input key.	<table border="1" style="display: inline-table; vertical-align: middle;"><tr><td>1</td><td>0</td><td>0</td></tr></table>	1	0	0	Chamber temperature setting value 10.0 is displayed.
1	0	0				
6	Press the menu button (MENU).	MENU	MENU window is displayed.			
7	Select +/- in MENU window pressing the shift key (downward).	▼	+/- is displayed in white letters.			
8	Press the enter key (ENTER).	ENTER	Chamber temperature setting value -10.0 is displayed.			
9	Press the enter key (ENTER).	ENTER	Next item (Light Step) is displayed in white letters.			
10	Press the menu button (MENU).	MENU	MENU window is displayed. OK is already selected (displayed in white letters).			
11	Press the enter key (ENTER).	ENTER	The set value is memorized and top screen is displayed.			

CAUTION

· The settable range of chamber temperature is between -10 °C and +60 °C.
 The lighting is available just under the specified setting range of temperature between +2 °C and +50 °C when the optional light add on kit (MIR-L15) is installed. In case of setting temperature out of this range, the lighting is not usable. The lamp will automatically turn off at temperature outside the +2 °C and +50 °C range when the program already saved is running.
 In this case, temperature fluctuation may exceed ±1.5 °C or it may take longer time to pull down the chamber temperature.

PROCEDURES OF SETTING VALUE

Setting of Key Lock

Procedures of changing Key Lock setting are shown below.

Procedures of Key Lock (Changing Key Lock setting from 0 (Unlock) to 1 (Lock)).

	Operation	Key	LCD Display
1		----	Top screen is displayed.
2	Press the menu button (MENU).	MENU	MENU window is displayed.
3	Select Std-by in MENU window pressing the shift key (downward).	▼	Std-by is displayed in white letters.
4	Press the enter key (ENTER).	ENTER	Stand-by Setting screen is displayed and chamber temperature setting value is changed into white letters.
5	Select Key Lock item pressing Shift keys.	▼	Set value of (Key Lock) is displayed in white letters.
6	Change the value from 0 to 1 pressing the character input key.	1	Set value of (Key Lock) is displayed in "1".
7	Press the enter key (ENTER).	ENTER	The value of top item (Temperature) is displayed in white letters. "Key Lock" is displayed in first line.
8	Press the menu button (MENU).	MENU	MENU window is displayed. OK is already selected (displayed in white letters).
9	Press the enter key (ENTER).	ENTER	The set value is memorized and top screen is displayed.

Procedures of Key Unlock (Changing Key Lock setting from 1(Lock) to 0(Unlock)).

	Operation	Key	LCD Display
1		----	Top screen is displayed.
2	Press the menu button (MENU).	MENU	MENU window is displayed.
3	Select Std-by in MENU window pressing the shift key (downward).	▼	Std-by is displayed in white letters.
4	Press the enter key (ENTER).	ENTER	Stand-by Setting screen is displayed and chamber temperature setting value is changed into white letters.
5	Select Key Lock item pressing Shift keys.	▼	Set value of (Key Lock) is displayed in white letters.
6	Change the value from 1 to 0 pressing the character input key.	0	Set value of (Key Lock) is displayed in "0".
7	Press the enter key (ENTER).	ENTER	Item of (Password) is displayed.
8	Set the password pressing the character input key.	0 0 0 0	The password **** is displayed.
9	Press the enter key (ENTER).	ENTER	The value of top item (Temperature) is displayed in white letters. "Key Lock" in first line is disappeared.
10	Press the menu button (MENU).	MENU	MENU window is displayed. OK is already selected (displayed in white letters).
11	Press the enter key (ENTER).	ENTER	The set value is memorized and top screen is displayed.

HIGH LIMIT/LOW LIMIT ALARM (MENU/Std-by)

A high limit temperature alarm and low limit temperature alarm are provided with this product. The alarm temperature can be changed as follows:

1. With the top screen displayed, press the menu button (MENU) to show the menu window. Select "Std-by", and press the enter key (ENTER).

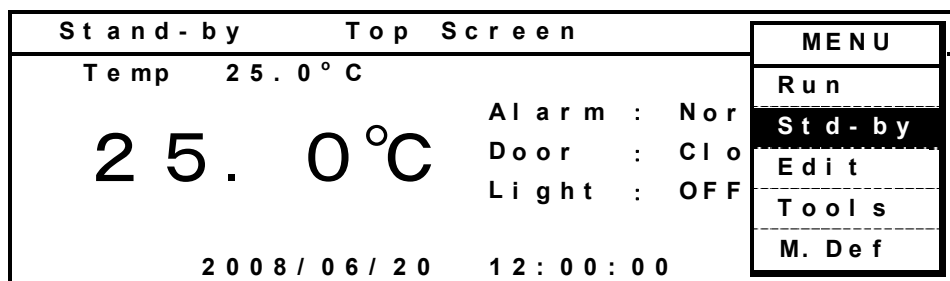

2. Stand-by Setting screen is displayed.

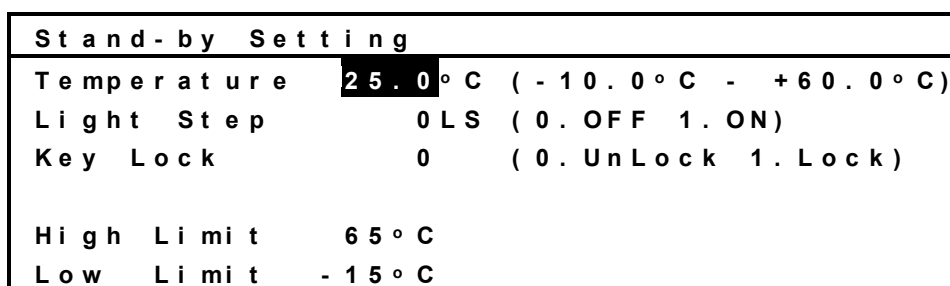

3. Set the desired high limit temperature alarm by turning the high limit temperature alarm volume (HIGH LIMIT) at the center of the control panel by using a small screw driver. The settable alarm temperature is between 15.0 °C and 65.0 °C.

Note:

Set the high limit temperature alarm (High Limit) 5 °C or higher than the maximum temperature in a program or stand-by operation.

4. Set the desired low limit temperature alarm by turning the low limit temperature alarm volume (LOW LIMIT) at the center of the control panel by using a small screw driver. The settable alarm temperature is between -15.0 °C and 20.0 °C.

Note:

Set the low limit temperature alarm (Low Limit) 5 °C or lower than the minimum temperature in a program or stand-by operation.

5. Press the menu button (MENU) at the completion of setting. The menu window is shown. Select "OK" and press the enter key (ENTER). The alarm temperature is memorized.

Refer to alarms and safety functions of page 46 for details.

Note:

High limit temperature alarm (High Limit) and low limit temperature alarm (Low Limit) are effective during a programmed running as well.

At any time when Stand-by Setting screen is not displayed, turning the high and low limit temperature alarm volume (HIGH LIMIT or LOW LIMIT) causes change of the setting value.

To avoid unexpected alarm, set High Limit or Low Limit temperature after actual temperature of chamber reaches to the set temperature of operation.

PROGRAMMING (MENU/Edit)

This product has two modes, which are clock mode and timer mode. The clock mode is used to set a change time to the next step in a day time (24 hours). The timer mode is used to set a time for each step directly and the remained time is displayed.

The selection of either mode is available on the running mode selection screen at the starting of the program.

Example 1:

Following shows the procedure to create a new program "Oze" of which cycle is 31 with clock mode. The details of "Oze" is as follows:

Start time (H)	6:00	9:00	11:00	13:00	15:00	17:00	19:00	21:00	22:00	23:00	6:00
Temp (°C)		12	15	20	25	20	18	15	15	12	10
Lighting		0	1	0	1	0	1	0	1	0	1

1. With the top screen displayed, press the menu button (MENU) to show the menu window.

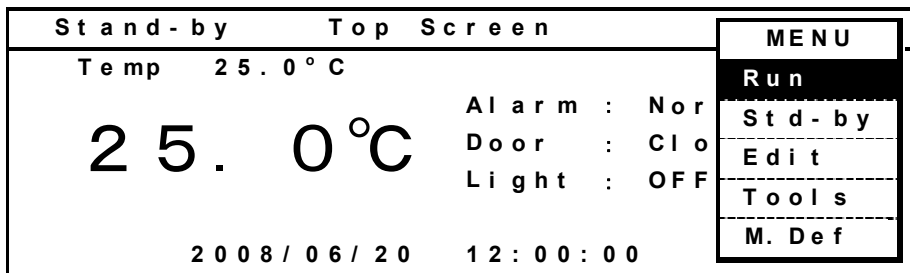

2. Select "Edit", and push the enter key (ENTER).

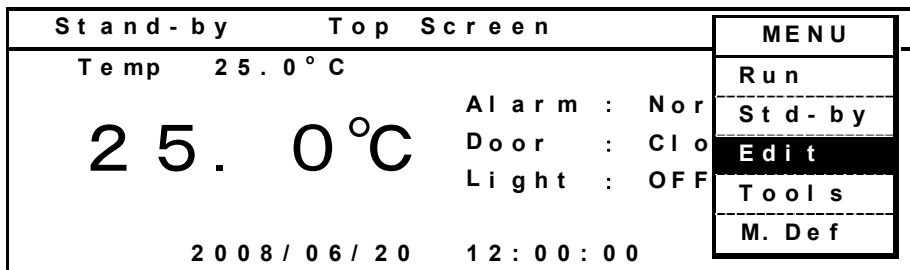

3. The Program Name Stored screen is opened. Press the menu button (MENU) and select "New", and press the enter key (ENTER). The program names are displayed when some programs have already been saved.

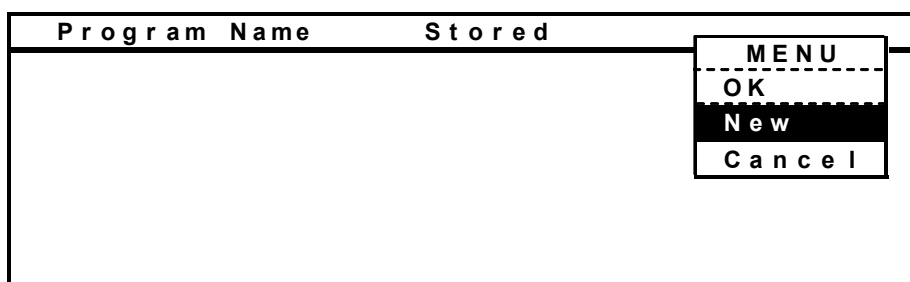

4. A model program is displayed.

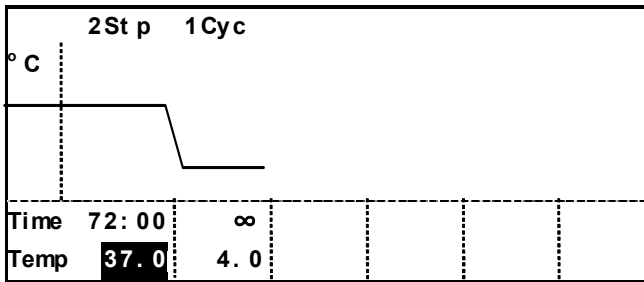

The step number (Stp :step) and cycle number (Cyc :repeat number) can be changed on the top left corner (2 Stp 1 Cyc) of the screen. Highlight the numerical value by shift key, and input 10 Stp 31 Cyc by character input key. The step number and cycle number are changed. The screen is scrolled to the next page by using the rightward shift key.

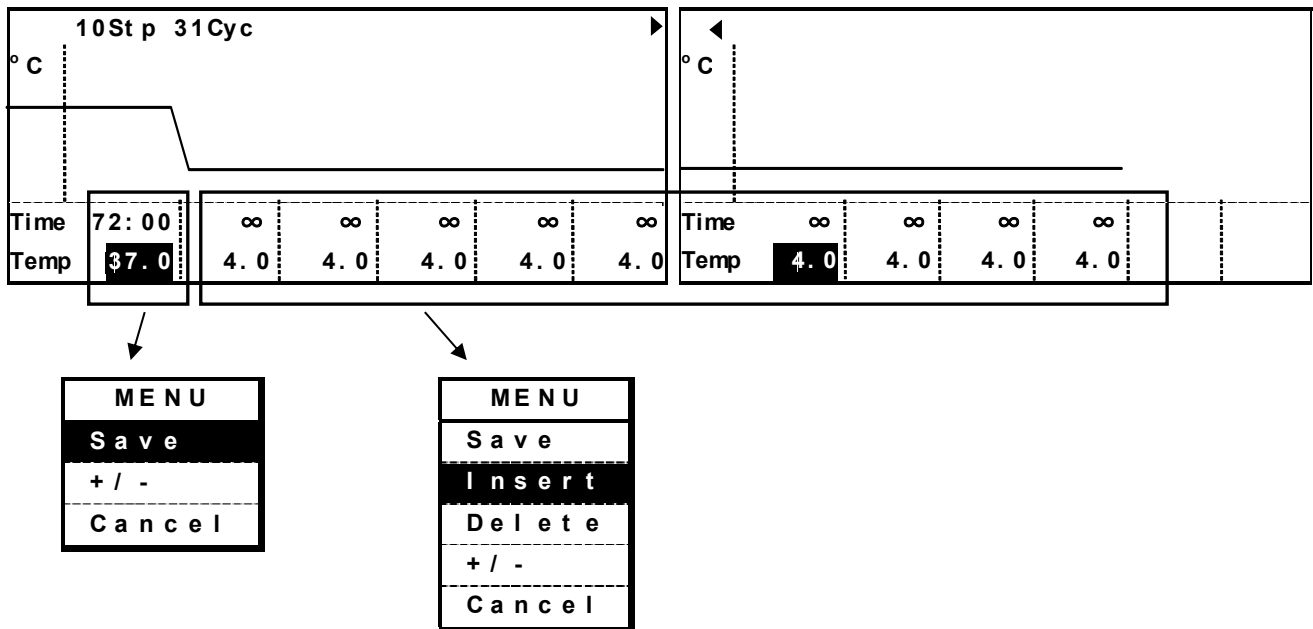

The step number (Spt) can be changed by “Insert” or “Delete” on the menu window. Press the menu button (MENU), to open the menu window. The menu window for a first section has no “Insert” or “Delete”. Therefore, neither insert nor delete is effective for the first section. The maximum step number is 12. The cycle number is 1 when the step number is 1. The settable cycle number is up to 98. The cycle number 99 means limitless repeat.

PROGRAMMING (MENU/Edit)

5. Highlight the numerical value of each time section (Time) by shift key, and input as below by character input key.

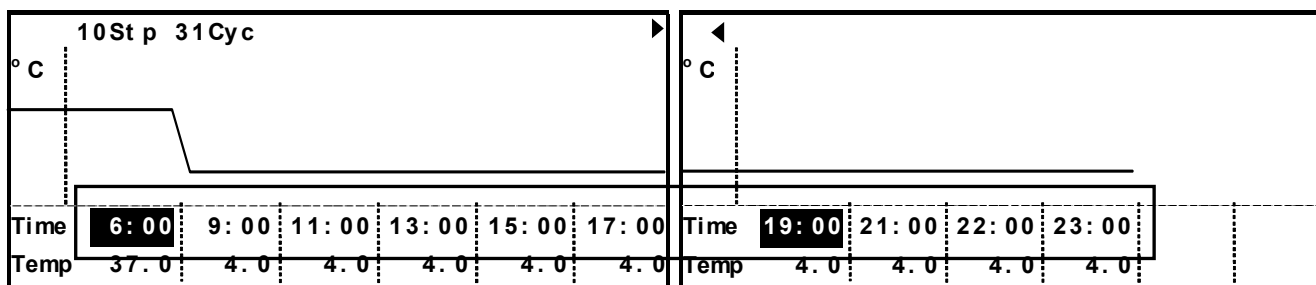

CAUTION

The time setting value depends on each mode, clock mode and timer mode. In the case of clock mode, the setting range is between 00:00 and 23:59. If the setting is larger than 24:00, the step of immediately before is repeated limitlessly. Set the step with timer order. If an earlier time than the previous step is inputted, the previous step is skipped. In the case of timer mode, setting range is between 00:01 and 99:59. The setting of "99:99" causes limitless repeat.

6. Shift a cursor downward by the downward shift key. Set the temperature as follows. The setting range is between -10.0 °C and 60.0 °C.

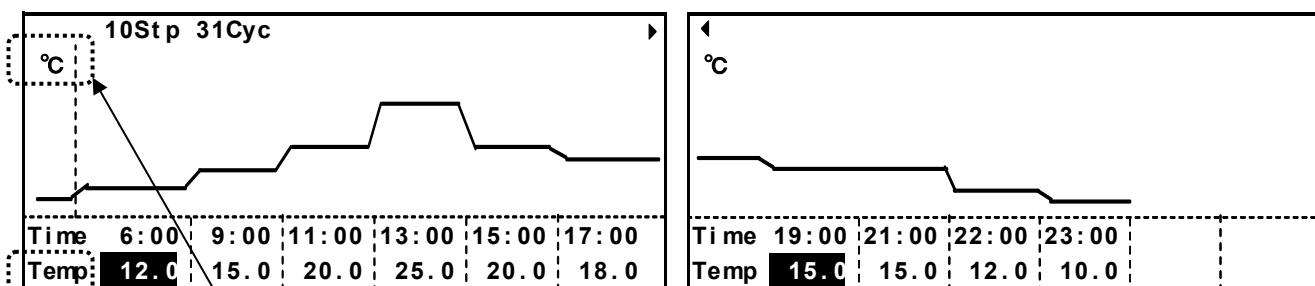

During temperature setting, "°C" is displayed at upper left.

MENU
Save
+ / -
Cancel

When adding the "-" to the set value of temperature or erasing the "-" from the set value of temperature, press the menu button (MENU) to show the menu window. Select +/- and press the enter key (ENTER).

CAUTION

The settable temperature is between -10.0 °C and 60.0 °C. The temperature control range is between 2 °C and 50 °C when light add on kit (MIR-L15; sold separately) is installed. In this case, temperature fluctuation may exceed ± 1.5 °C or it may take longer time to pull down the chamber temperature.

CAUTION

The unit continues to run with a step just before the step having time setting of over 24:00 when a program is run in clock mode.

7. Shifting a cursor downward by downward shift key moves to the next edit "Light" (light step).

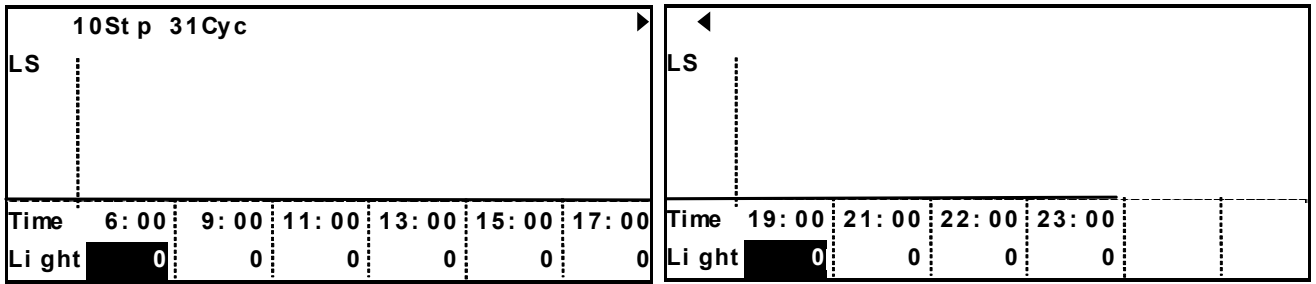

Set a light step as below. To set 0(OFF) or 1(ON).

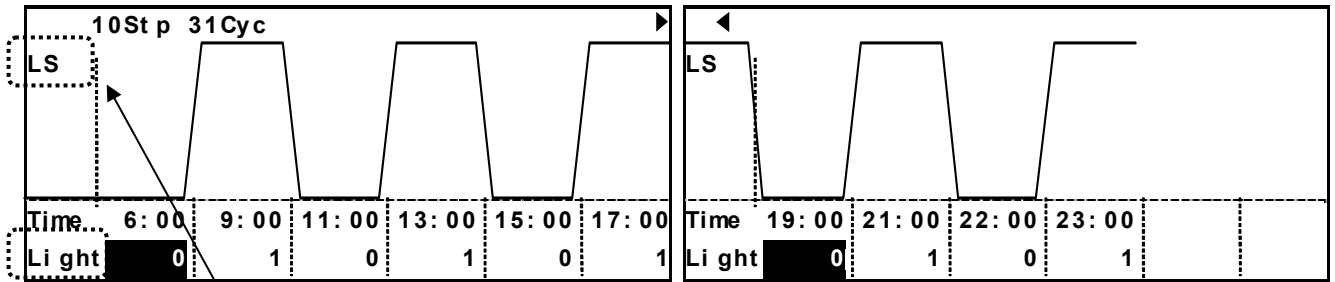

When setting Light step, "LS" displayed at the upper left and "Light" at the lower left on the top screen.

8. Shifting a cursor downward by downward shift key moves to the next edit "Temp" (Temperature).

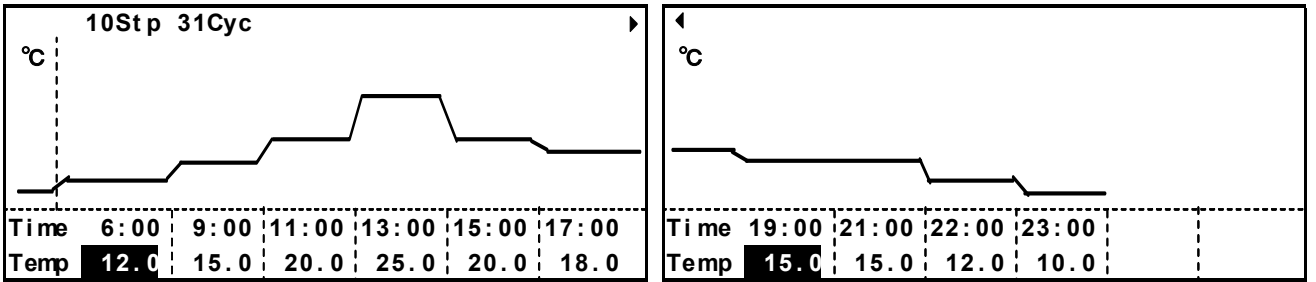

9. At the completion of all input, press the menu button (MENU) to show the menu window. Select "Save", and press the enter key (ENTER). Save Program screen is opened.

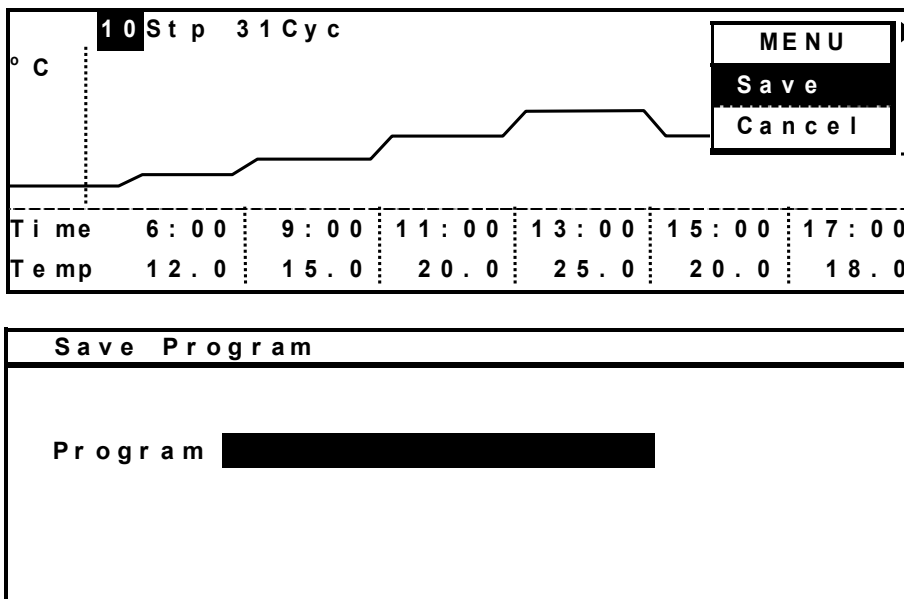

PROGRAMMING (MENU/Edit)

10. Input a program name (Oze), and press the menu button (MENU) to show the menu window. Select "Save As", and press the enter key (ENTER). The program is entered. The maximum numbers of character for program name is 16. Refer to edit function of characters described below. Up to 10 programs are created and saved.

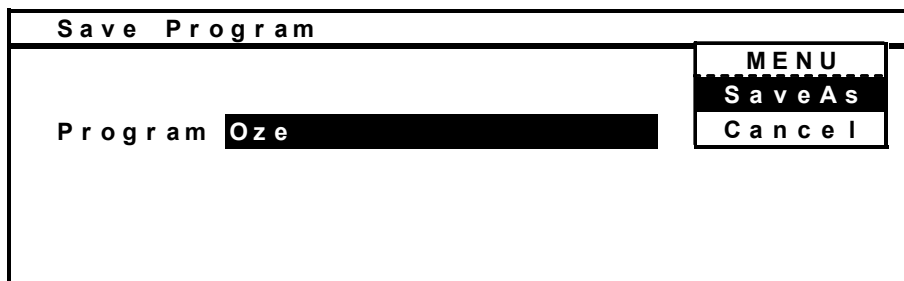

Edit function of characters

Shift key

- **Upward shift key:** Space insertion
- **Downward shift key:** backspace
- **Leftward shift key:** Move a cursor left
- **Rightward shift key:** Move a cursor right

Character input key

- | | | | |
|---------------------------------|-----------------------------|---------------------------------|----------------------------|
| 1 key: space,-,"#,@,1 | 2 key: A,B,C,a,b,c,2 | 3 key: D,E,F,d,e,f,3 | |
| 4 key: G,H,I,g,h,i,4 | 5 key: J,K,L,j,k,l,5 | 6 key: M,N,O,m,n,o,6 | |
| 7 key: P,Q,R,S,p,q,r,s,7 | 8 key: T,U,V,t,u,v,8 | 9 key: W,X,Y,Z,w,x,y,z,9 | 0 key: &,/,,(,),.,0 |

11. Return to the top screen after saving program.

Example 2:

To create the following program with timer mode and name "NIKKO". The cycle is 99, that is limitless repeat.

Step Time	48	36
Temperature (°C)	20	30
Light Step	0	1

1. Display a model program as shown on page 22.

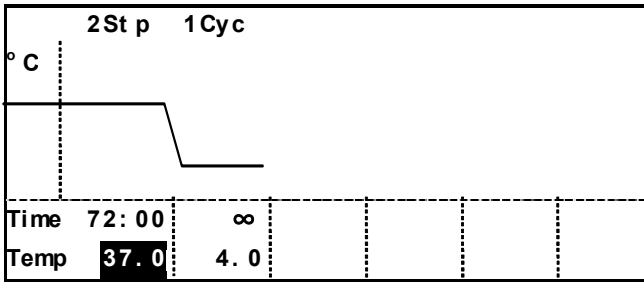

Change the step number and cycle number to 2 Stp and 99 Cyc by character input key. Only one page is displayed and 99 is changed into ∞. Display of ∞ changes 99 when lapped by a cursor.

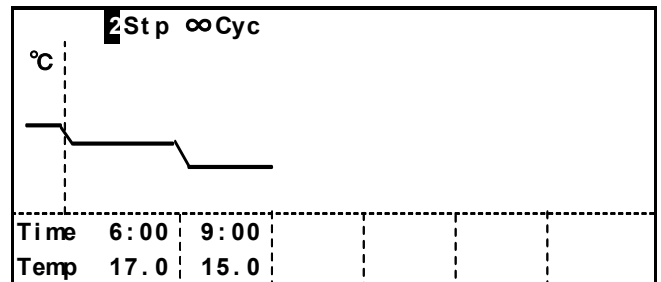
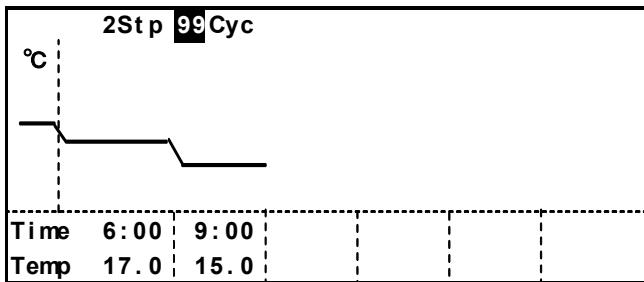

2. Set a time, temperature and light step as same as Example.1.

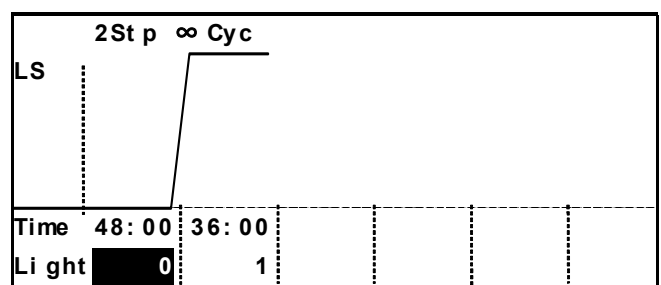
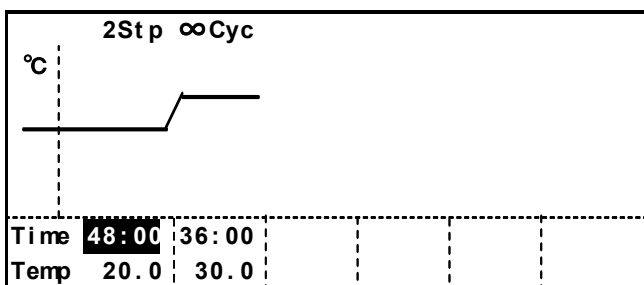

3. Input a program name (NIKKO), pres the menu button (MENU) to show the menu window. Select "Save As", and press the enter key (ENTER) to save the program as same as Example.1.

EDIT OF SAVED PROGRAM (MENU/Edit)

1. With the top screen displayed, press the menu button (MENU) to show the menu window. Select "Edit", and press the enter key (ENTER).

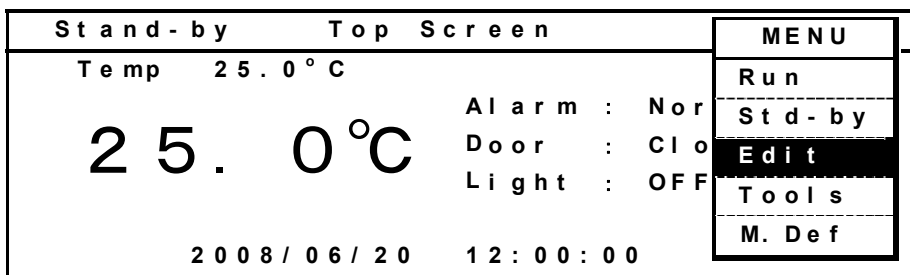

2. The saved programs are shown. Select a program (for example : Oze) to edit, and press the menu button (MENU). The menu window is opened. Select "OK", and press the enter key (ENTER).



3. The program "Oze" is displayed. After changing the setting, press the menu button (MENU) to show the menu window. Select "Save", and press the enter key (ENTER).

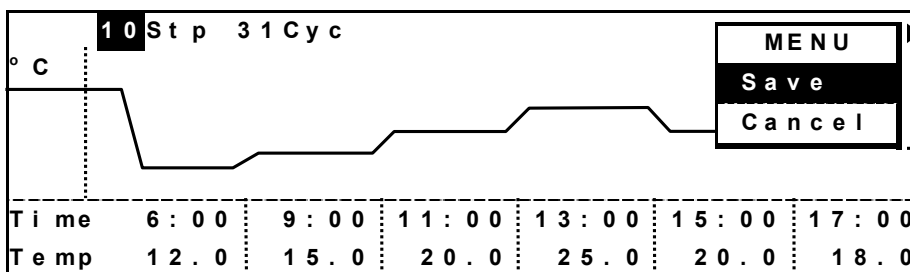

4. Save Program screen is opened. Input program name, and press the menu button (MENU) to show the menu window. Select "Save" when saving by overwriting, or select "SaveAs" when saving with another program name. Press the enter key (ENTER). The edited program is entered. Do not select "SaveAs" with same program name as another program.

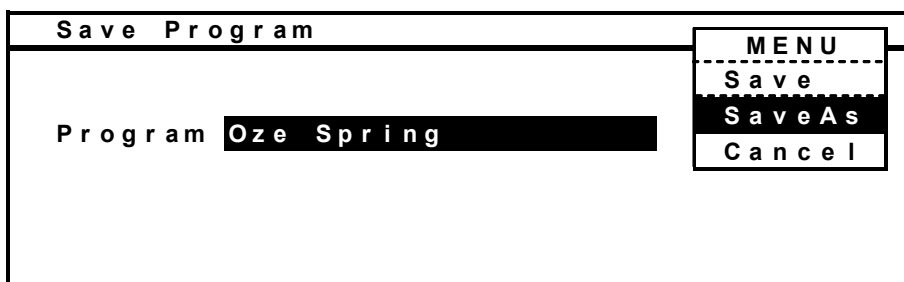

START OF PROGRAM (MENU/Run)

1. With the top screen displayed, press the menu button (MENU) to show the menu window. Select "Run", and press the enter key (ENTER).

Stand-by		Top Screen		MENU	
Temp	25.0°C	Alarm	: Nor	Run	
25.0°C		Door	: Clo	Std-by	
		Light	: OFF	Edit	
2008/06/20		12:00:00		Tools	
				M. Def	

2. Program Name Stored screen is opened. Select "Oze" and press the menu button (MENU) when starting "Oze" program. Select "OK" on the menu window, and press the enter key (ENTER).

Program Name	Stored	MENU	
Oze	08/06/18 15	OK	
NIKKO	08/06/18 16	Cancel	

3. Start Options screen is opened. On this screen, setting of Timer (selection of Clock mode or Timer mode), Join (Joining some programs), and start date is available. As the "Oze" is for clock mode, select 1 (Clock) for Timer. For join, select 2 (No : not join) since the Oze does not have joined program. Input the start date (Ex.2008 10 01) and time (Ex.06:00:00), and press the menu button (MENU) to show the menu window. Select "OK", and press the enter key (ENTER).

Start Options	
Timer	1 (1. Clock 2. Dec)
Join	2 (1. Yes 2. No)
Start at	
Date	08/10/01 (YY/ MM/ DD)
Time	06:00:00 (hh: mm: ss)

■ Timer (selection of Clock mode or Timer mode)

1. Clock (Clock mode): Displays start time of each steps.
2. Dec (Timer mode): Displays the remaining time up to a next step.

■ Join (Joining some programs)

Join 1.Yes: The joined programs are operated when a selected program is set as a join program. Refer to page 31 for details.

■ Start at (desired start date)

First, date and time when the window is opened is displayed. Input the desired start date and time.

START OF PROGRAM (MENU/Run)

4. The selected program is displayed. Check the program and press the menu button (MENU) to show the menu window. Select "Start", and press the enter key (ENTER).

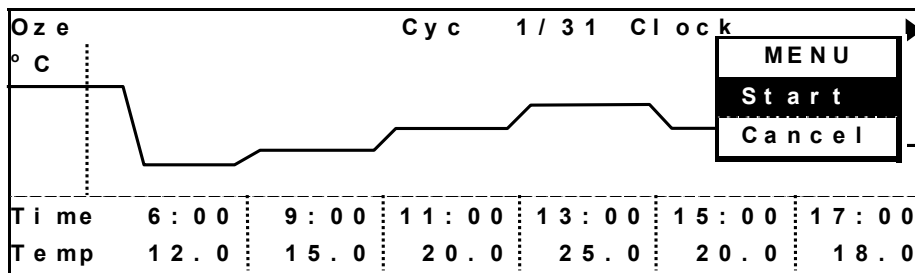

5. The program is started at desired date and time. During the programmed running, the graphic screen as below is displayed. To change the graphic screen to the top screen, press the menu button (MENU) to show the menu window. Select "Top" and press the enter key (ENTER). To change to the graphic screen, press the menu button (MENU) to show the menu window. Select "Graph" and press the enter key (ENTER).

When the starting time of program operation is later, "Waiting" is displayed in the current running status of LCD panel.

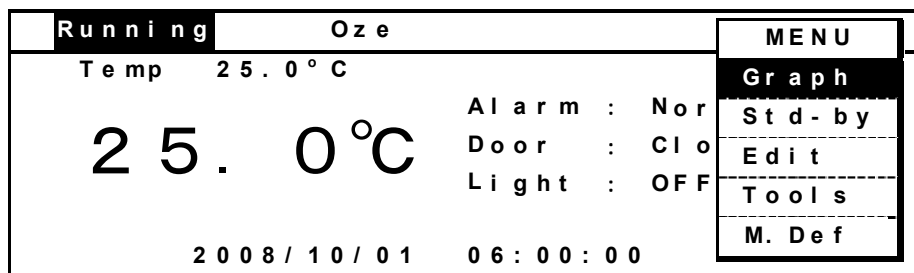
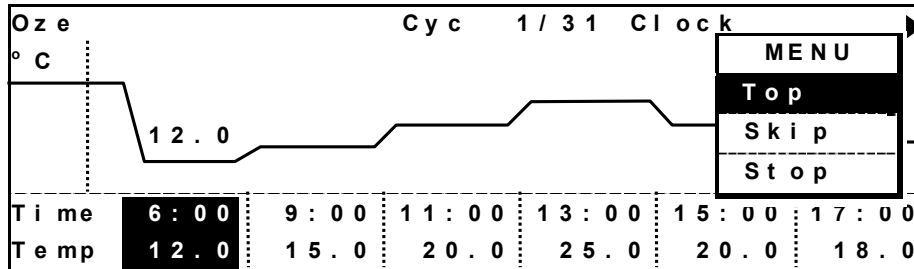

JOIN FUNCTION

This product has join function to run several programs continuously. The maximum programs to be joined are 9. The setting of join function is as follows:

1. When joining three programs Spring, Summer and Autumn, input the same character string, # and one digit figure (joined order) before the each program name. Each program operates as a special program for join function. Any character or figure is permitted for a string on the top. The programs cannot be joined when the character string is not same.

Note: The characters after one digit figure have no effect on the join function.

Ex.1: When joining the programs Spring, Summer and Autumn in this order and top character string is "Oze" the input for the join function is as follows:

Oze#1 Spring Oze#2 Summer Oze#3 Autumn

Ex.2: When joining in the order of Autumn, Spring and Summer in this order and input "NIKKO" as the same character string, the input for the join function is as follows:

NIKKO#1 Autumn NIKKO#2 Spring NIKKO#3 Summer

2. When running the joined program in Ex.1, select the program Oze#1 Spring on the Program Name Stored screen in MENU/Run (Refer to page 29).

Note: The program Oze#2 Summer is selected, the program Oze#2 Summer and Oze#3 Autumn are performed. Oze#1 Spring is not joined.

3. Select 1.Yes for the join function on the Start Options screen. Press the menu button (MENU) to show the menu window. Select "OK" and press the enter key (ENTER).

Note: The joined function is not effective if select 2. No on the Start Options screen.

4. Press the menu button (MENU) to show the menu window. Select "Start" and press the enter key (ENTER). The joined program is started.

5. Running result

Run in the order of Oze#1 → Oze#2 → Oze#3. During the running of joined program, "Join" is displayed at the upper right on the screen.

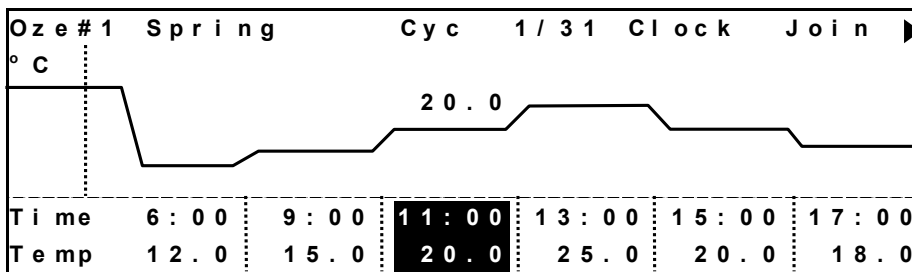

SKIP OF STEP (MENU/Skip)

During the programmed running, the skip function is effective to skip a current step in the program.

1. Press the menu button (MENU) to show the menu window and select "Graph" when the top screen is displayed. Then press the enter key (ENTER).
2. Press the menu button (MENU) under program running and the menu window is opened. Select "Skip", and press the enter key (ENTER).

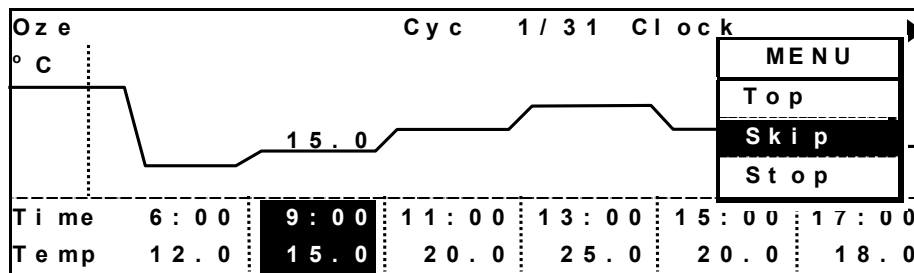

3. The Confirmation screen is displayed. Press the menu button (MENU). Selecting "Next" causes the skip to the next step. Selecting "Back" causes the skip to the previous step. After selecting "Next" or "Back", press the enter key (ENTER).

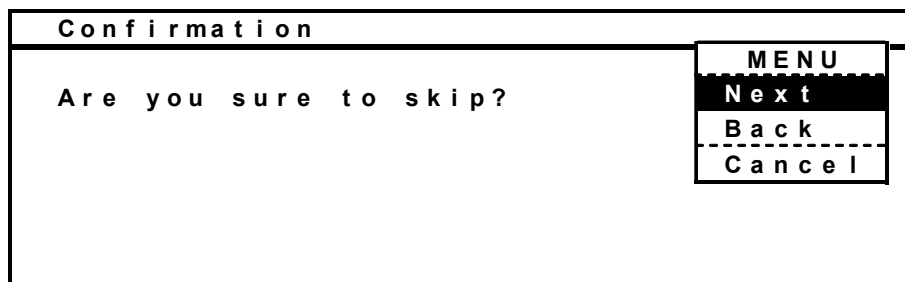

4. Programmed running shifts to next step and programmed running continues.

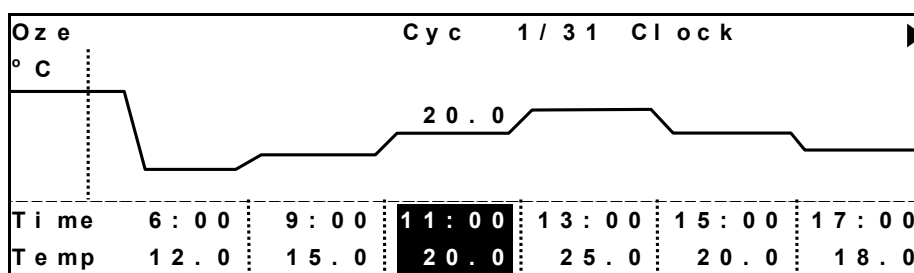

STOP OF PROGRAM (MENU/Stop)

During the programmed running, it is possible to stop the running at any step.

1. During the programmed running, press the menu button (MENU) to show the menu window and select "Graph" when the top screen is displayed. Then press the enter key (ENTER).
2. Press the menu button (MENU) under program running and the menu window is opened. Select "Stop", and press the enter key (ENTER).

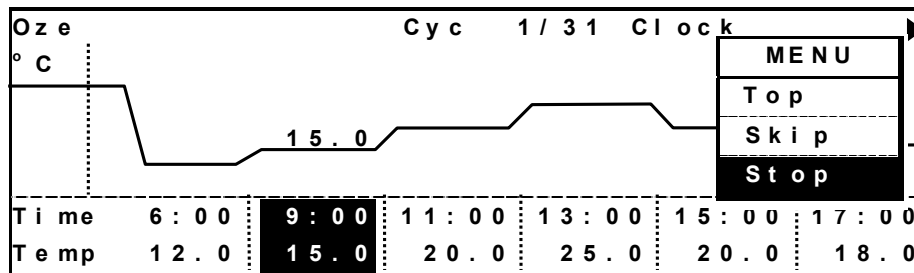

3. The Confirmation screen is displayed. Select "OK" and press the enter key (ENTER) to stop the program.

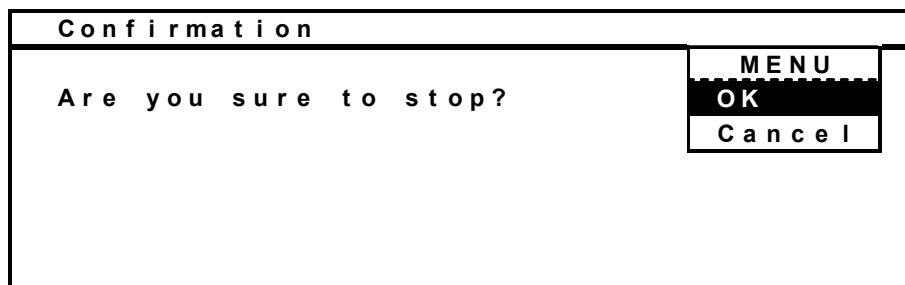

4. After stopping the program, the top screen is displayed.

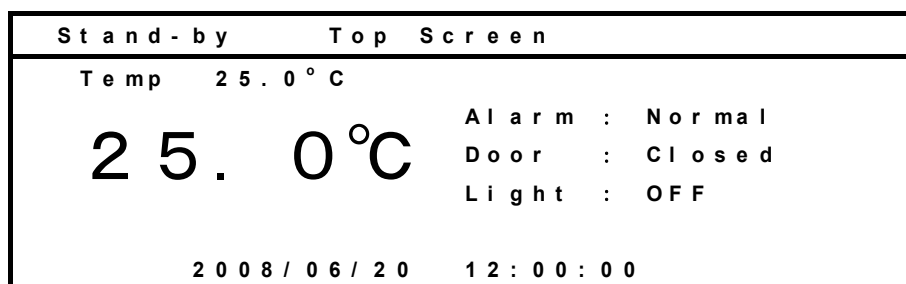

AUTOMATIC DEFROST (MENU/Tools/Date Time)

This product has a frost check opening to check amount of the frost on the evaporator that lowers temperature in a chamber. Automatic defrost function defrosts the frost on the evaporators automatically at the specified time everyday. Default setting is 0(Manual).

1. Press the menu button (MENU) to show the menu window and select "Tools" when the top screen is displayed. Then press the enter key (ENTER).
2. Select "Date Time" on the Select Tools screen, and press the menu button (MENU) to show the menu window. Select "OK" and press the enter key (ENTER).

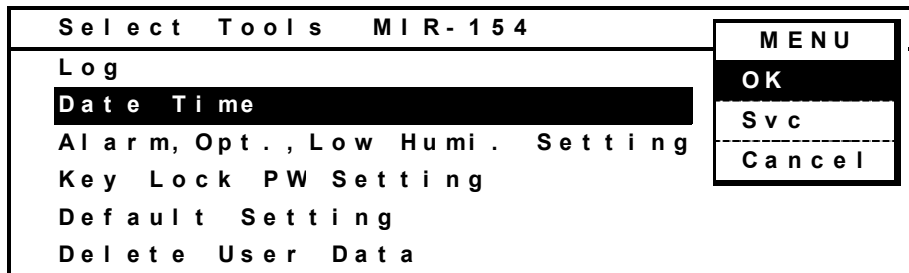

3. The Date Time screen is displayed. Select the Def Timer (Automatic defrost function) 0 (Manual) or 1 (Auto). When selecting 0 (Manual), automatic defrosting is not done. When selecting 1 (Auto), it is possible to set the time to defrost automatically in every one hour between 0:00 and 23:00.

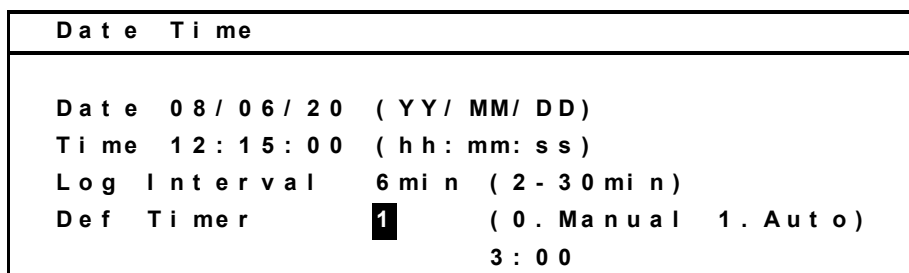

CAUTION

Automatic defrosting is activated even in programmed running, and the chamber temperature may arise due to the amount of the frost existing on the evaporator. In this case, manual defrosting is recommended.

CAUTION

During defrosting, "Defrosting" is displayed on running status of LCD panel. Care should be taken for deviation of setting and current temperature during defrosting. In case of long term running of setting temperature below 5 °C, expected running will be failed due to frost. Defrosted water will be evaporated automatically outside of the chamber.

- Defrosting is likely not to operate when the inner temperature is over 5 °C.
- Frost will exist on the evaporator when temperature setting is below 5 °C. Frost-clogged evaporator causes insufficient cooling and inner temperature rising. When a lot of frost existed on the evaporator is seen through the frost check opening, immediate defrosting is required. Frosting on the evaporator is accelerated when moisturized material is put inside the chamber.

MANUAL DEFROST (MENU/M.def)

The manual defrost function is for defrosting the frost on the evaporator at any time. When a lot of frost on the main evaporator is found, start the manual defrost. Besides this function, it is possible to set the automatic defrost function. (Refer to page 34)

1. Press the menu button (MENU) to show the menu window. Select "M.Def" and press the enter key (ENTER).

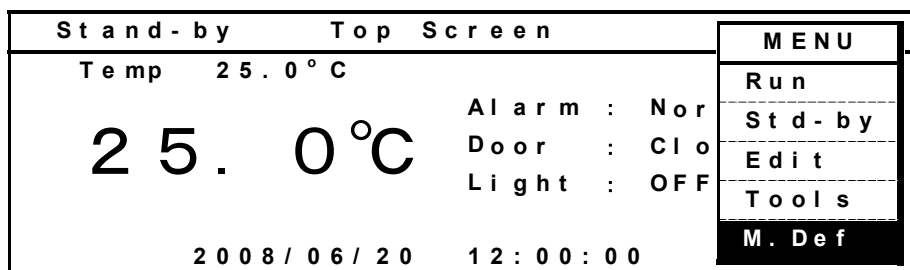

2. The Confirmation screen is displayed.

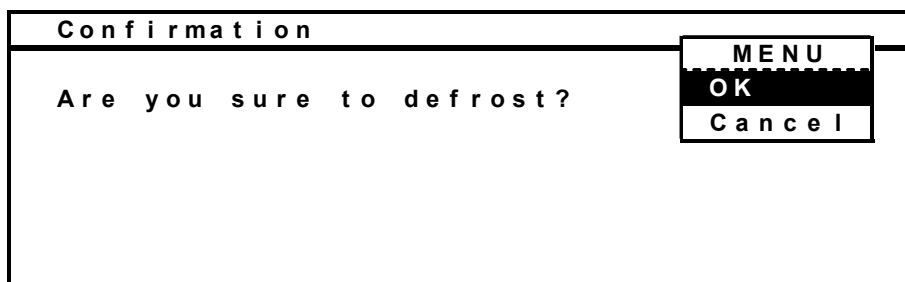

3. Select "OK", and press the enter key (ENTER). The manual defrost is started. During defrosting, "Defrosting" is displayed at the upper left on the top screen.

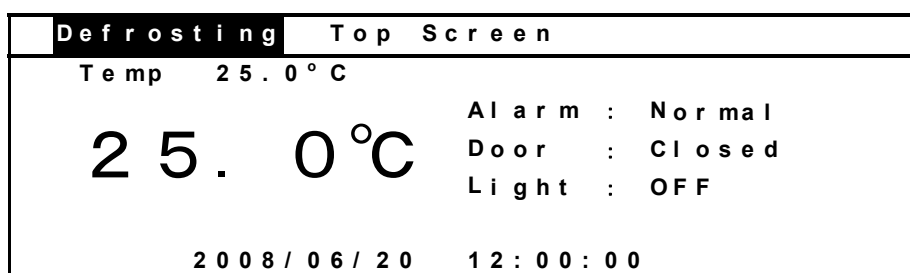

CAUTION

The manual defrost can be started during programmed running, standby operation, or automatic defrosting.

4. The manual defrost is finished automatically. The defrosting time depends on the amount of frost on the evaporator.

VARIOUS SETTING (MENU/Tools)

The log can be displayed and various setting can be changed by using "Tools" menu.

1. Press the menu button (MENU) with the top screen to show the menu window. Select "Tools", and press the enter key (ENTER).

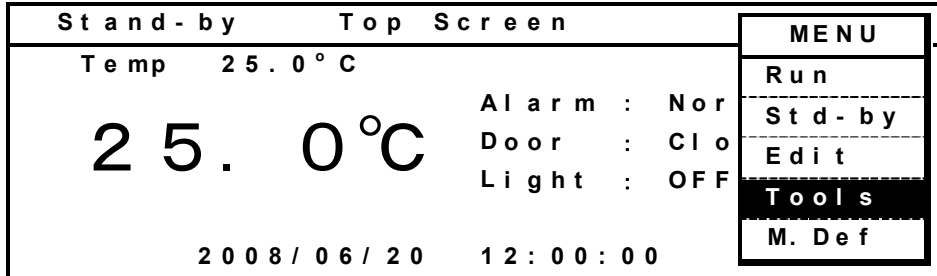

2. The Select Tools screen is as follows.

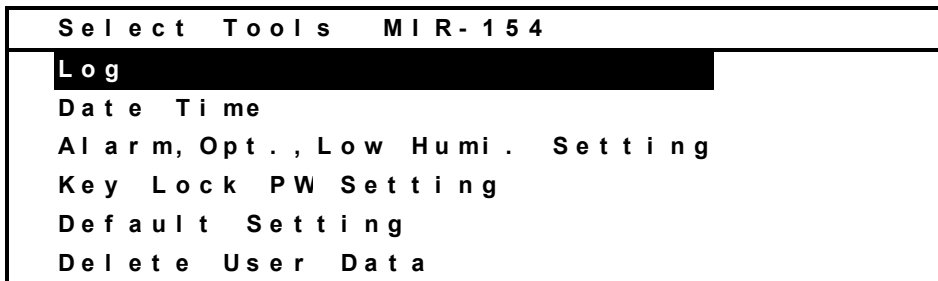

Display of log (Tools/Log)

1. Select "Log" in the Select Tools screen. Press the menu button (MENU) to show the menu window. Select "OK", and press the enter key (ENTER).

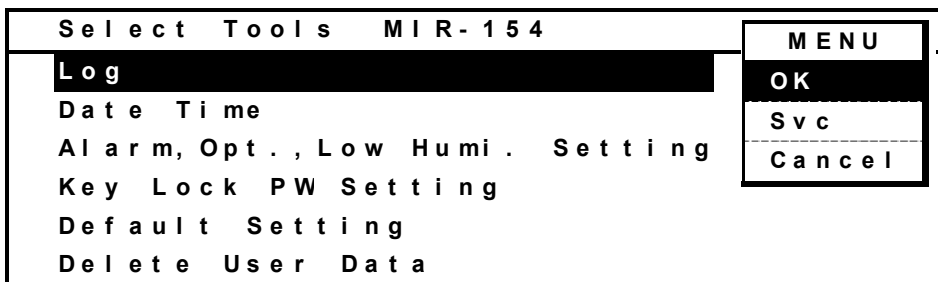

2. The log is presented with dot. By pressing the upward shift key or downward shift key, the log to be displayed is changed; temperature and light step. The displayed date is scrolled by pressing the leftward or rightward shift key. (leftward shift key; older date, rightward shift key; newer date.)

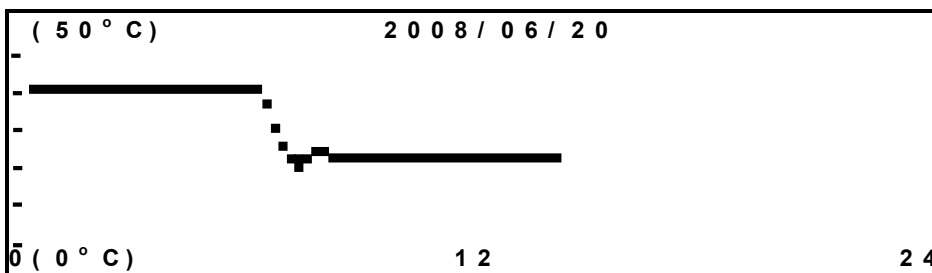

3. The display area (upper and lower limit) can be changed. Press the menu button (MENU) to show the menu window. Select "Range2" and press the enter key (ENTER). Upper limit is changed from 50 °C to 60 °C and lower limit is changed from 0 °C to -10 °C.

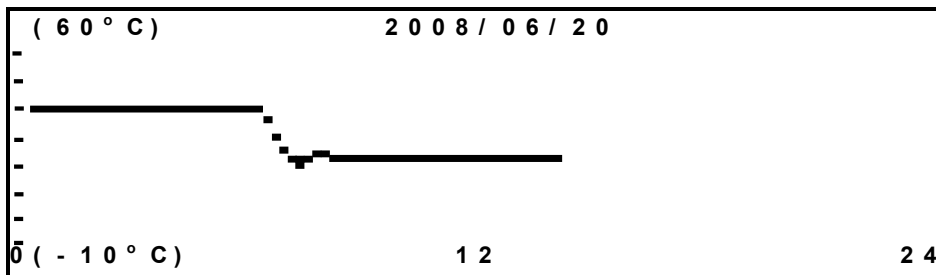
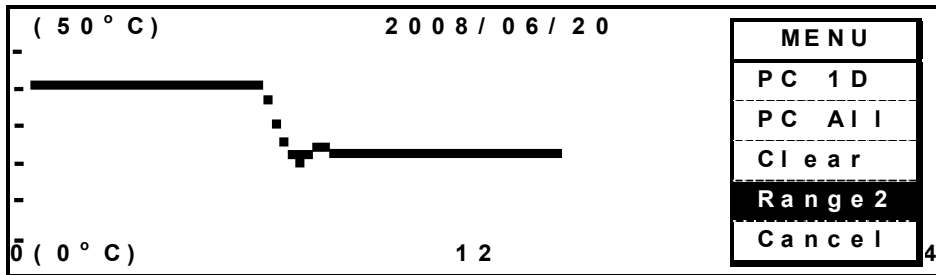

Similarly, select "Range1" and press the enter key (ENTER). Upper limit is changed from 60 °C to 50 °C and lower limit is changed from -10 °C to 0 °C.

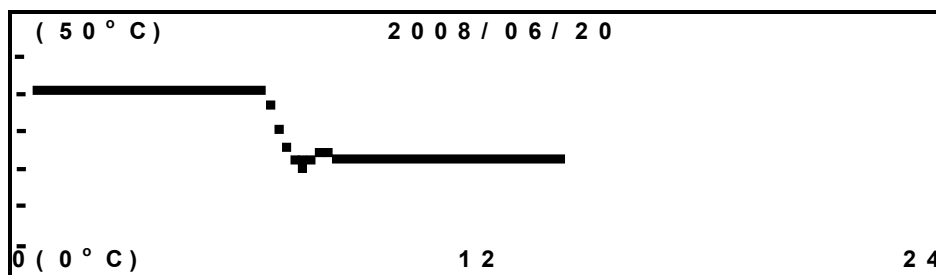
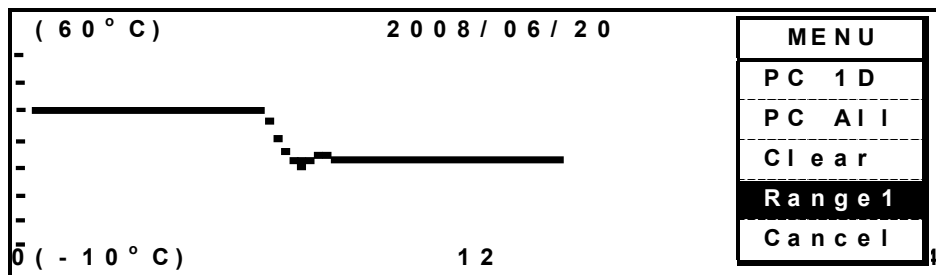

VARIOUS SETTING (MENU/Tools)

Data transmission

The procedure to transmit the log data to a PC is as follows.

1. Press the menu button (MENU) to show the menu window. Select "PC 1D", and press the enter key (ENTER) when the log for one day is necessary. Select "PC All", and press the enter key (ENTER) when all data recorded is necessary.

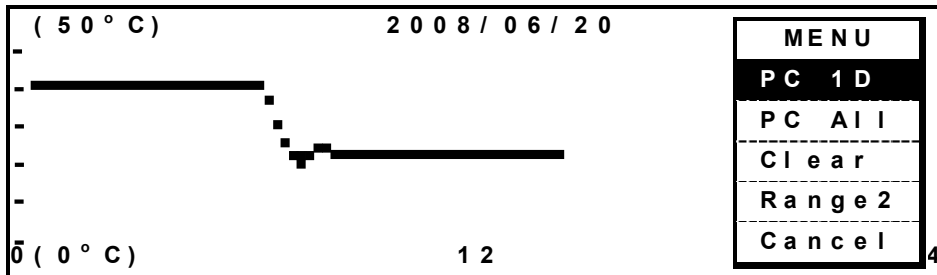

2. The Progress screen is displayed. Specify a transfer, capture of text and retention file name by operation of hyper terminal on PC. Apply "txt" or "csy" to retention file as an extension. Press the menu button (MENU) to show the menu window. Select "Start", and press the enter key (ENTER). The transmission is started. "Finished" display means the end of transmission.

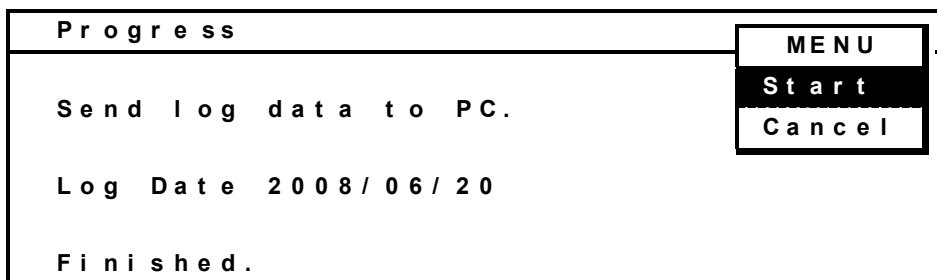

Setting in PC side for transmission of log data

As for setting in PC side for transmission of log data, please contact our sales representative or agent.

Setting of date, time, log (Tools/Date Time)

1. Select "Date Time" in the Select Tools screen. Press the menu button (MENU) to show the menu window. Select "OK", and press the enter key (ENTER).

Select Tools MIR-154	
Log	MENU
Date Time	OK
Alarm, Opt., Low Humi. Setting	Svc
Key Lock PW Setting	Cancel
Default Setting	
Delete User Data	

2. The Date Time screen is displayed. Set date, time or log cycle.

Date Time	
Date	08 / 06 / 20 (YY / MM / DD)
Time	12 : 15 : 00 (hh : mm : ss)
Log Interval	6 min (2 - 30 min)
Def Timer	1 (0. Manual 1. Auto)
	3 : 00

■ Date input (Ex: June 20, 2008)
Input 080620 in the date cell.

■ Time input (Ex: 12:15:00)
Input 121500 in the time cell.

■ Log cycle input (Ex: 6 minutes)
Input 6 in log Interval cell.

Note:

- The default is 6 minutes.
- The acceptable range is between 2 minutes and 30 minutes.
- Relation between the log interval and spans that can be memorized
 - 1: Log interval 2 minutes About 5 days
 - 2: Log interval 6 minutes About 14 days
 - 3: Log interval 30 minutes About 70 days

After passing the memory limit, the older data is deleted and newer data is memorized.

■ Setting of automatic defrost

Select one of two defrosting patterns. The default is 0(Manual defrost). For the details of automatic defrost, refer to page 34~35.

0: Manual defrost

1: Automatic defrost

VARIOUS SETTING (MENU/Tools)

Alarm setting (Tools/Alarm, Opt., Low Humi. Setting)

1. Select "Alarm, Opt., Low Humi. Setting" in the Select Tools screen. Press the menu button (MENU) to show the menu window. Select "OK", and press the enter key (ENTER).

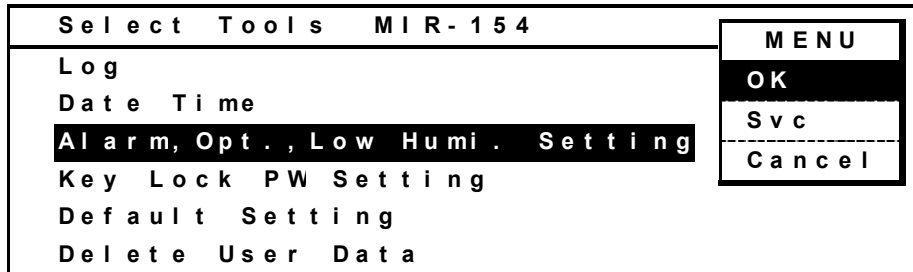

2. The Alarm, Option, Low Humidity Setting screen is displayed. On this screen, the temperature alarm (Temp Alarm), delay time of alarm (Alarm Delay), alarm resume time (Ring Back) and lamp (Lamp) can be set. The alarm buzzer is silenced by pressing the alarm buzzer stop key (BUZZER) during alarm condition. The buzzer will be activated again after certain suspension if the alarm condition continues. The suspension time (ring back) can be set.

Alarm, Option, Low Humidity Setting	
Temp Alarm	±2.5 °C (±1.0 °C - ±5.0 °C)
Alarm Delay	15 min (0 - 15 min)
Ring Back	30 min (0. OFF 1 - 99 min)
Lamp	0 (0. Normal 1. Option)
Low Humidity Mode	0 (0. No, 1. Yes)

The settable range:

- Temperature alarm (Temp Alarm): ±1.0 °C~±5.0 °C.
- Delay time of alarm (Alarm Delay): 0 minute~15 minutes.
- Suspension time (Ring Back): 1 minute~99 minutes, or OFF
- Optional light add on kit (MIR-L15) setting (Lamp): 0 (not installed) or 1 (installed)

3. When optional light add on kit (MIR-L15) is installed, the lamps will automatically turn off at temperature outside the +2 °C to +50 °C range when the program already saved is running. The set value of temperature is limited between +2 °C~+50 °C after Lamp is set to 1.

4. The condensation in the chamber is reduced by running control with the set temperature between +20 °C and +40 °C when the low humidity mode (Low Humidity Mode) is set to 1.

· The condensation can be found on the inside of the door or clearance in the chamber when running in humid chamber status without low humidity mode (Low Humidity Mode is set to 0).

CAUTION

It is not possible to change the delay time of door alarm, 2 minutes only. When door is open, "Open" is displayed on the top screen.

Key lock password setting (Tools/Key Lock PW Setting)

1. Select "Key Lock PW Setting" in the Select Tools screen. Press the menu button (MENU) to show the menu window. Select "OK" and press the enter key (ENTER).

Select Tools MIR-154	MENU
Log	OK
Date Time	Svc
Alarm, Opt., Low Humi. Setting	Cancel
Key Lock PW Setting	
Default Setting	
Delete User Data	

2. Input the Current User Password (4 digits) and press the enter key (ENTER).
The default User Password when shipped from the factory is "0000".

Key Lock PW Setting
Current User Password [REDACTED]

3. Input New User Password (4 digits) and press the enter key (ENTER).

Key Lock PW Setting
New User Password [REDACTED]

4. Input User Password (4 digits) again and press the enter key (ENTER).

Key Lock PW Setting
New User Password ****
Re Enter User Password [REDACTED]

VARIOUS SETTING (MENU/Tools)

Default setting (Tools/Default Setting)

1. Select "Default Setting" in the Select Tools screen. Press the menu button (MENU) to show the menu window. Select "OK", and press the enter key (ENTER).

Select Tools MIR-154	MENU
Log	OK
Date Time	Svc
Alarm, Opt., Low Humi. Setting	Cancel
Key Lock PW Setting	
Default Setting	
Delete User Data	

2. The Default Setting screen is displayed. Set the default for each parameter as necessary.

Default Setting	
LCD Back Color	1 (1. Blue 2. White)
DAQ Speed	0 (0. 2400 2. 9600)
DAQ ID	0 (0. OFF 1-250)
DAQ Mode	0 (0. Local 1. Remote)
Buzzer Finished	1 (1. Yes 2. No)
Analog Range	0 (0. Normal 1. Wide)

LCD Back Color: Setting of background color (1. Blue 2. White)

Buzzer Finished: Select of buzzer activation (1: Yes) or no activation (2: No) at the time of completion of a programmed running. (The buzzer activates 6 times when a program is finished.)

Analog Range: Select of analog output range of temperature in chamber (0: 0°C~50°C 1: -20°C~80°C)

Note:

DAQ is an external monitoring system of chamber status. It is necessary to set the DAQ Speed, DAQ ID and DAQ Mode when using communication software. Communication software is ordered specially contact our sales representative or agent.

Delete of program (Tools/Delete User Data)

1. Select "Delete User Data" in the Select Tools screen. Press the menu button (MENU) to show the menu window. Select "OK", and press the enter key (ENTER).

Select Tools	MIR-154	MENU
Log		OK
Date Time		Svc
Alarm, Opt., Low Humi. Setting		Cancel
Key Lock PW Setting		
Default Setting		
Delete User Data		

2. The Delete User Data screen is displayed. To select a program to deleted, select "Delete a User Program" and press the menu button (MENU) to show the menu window. Select "OK" and press the enter key (ENTER).

Delete User Data	MENU
Delete a User Program	OK
Delete All User Programs	Cancel

3. A list of saved programs is displayed. Select a program (Ex: Oze#1 Spring) to delete, press the menu button (MENU) to show the menu window. Select "Delete" and press the enter key (ENTER).

Program Name	Stored	MENU
Hatsuga	08/06/18 15	Delete
Oze#1 Spring	08/06/18 16	Cancel
Oze#2 Summer	08/06/18 20	
Oze#3 Autumn	08/06/18 21:45:00	

4. The Confirmation screen is displayed. Press the menu button (MENU) to show the menu window. Select "OK", and press the enter key (ENTER). The program (Oze#1 Spring) is now deleted.

Confirmation	MENU
Are you sure to Delete?	OK
Program name Oze#1 Spring	Cancel

VARIOUS SETTING (MENU/Tools)

5. To deleting all programs, select "Delete All User Programs" in Delete User Data screen and press the menu button (MENU) to show the menu window. Select "OK" and press the enter key (ENTER).

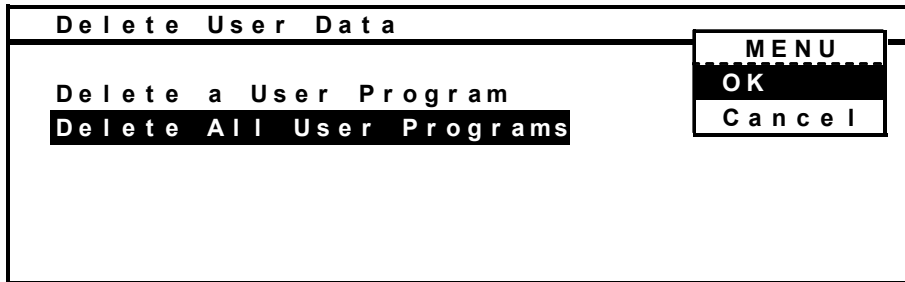

6. The Confirmation screen is displayed. The menu window is already displayed. Select "OK", and press the enter key (ENTER). All of the programs are now deleted.

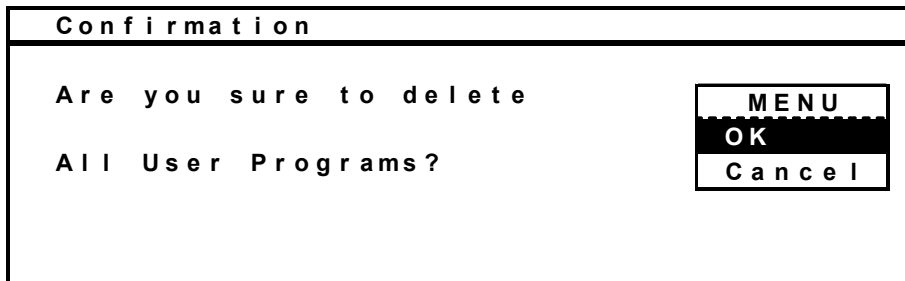

ADJUSTMENT OF SHELVES

The interval between the shelves can be adjusted depending on the height of the stored items. To install the shelves, insert the clip to the desired location.

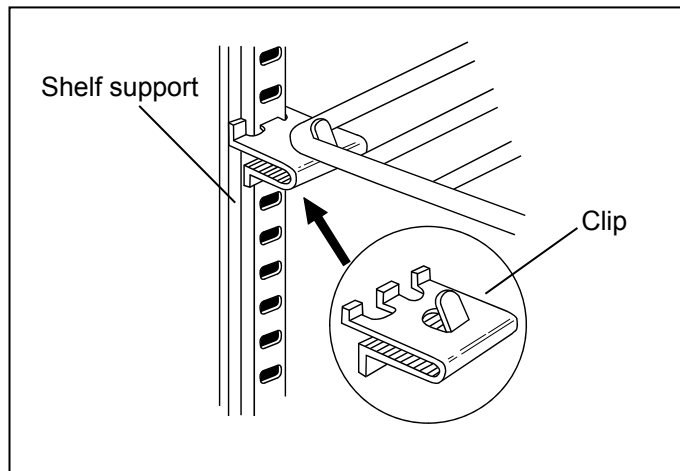

Note:

- The chamber is refrigerated by the forced circulation of cooled air inside the chamber. Ensure that the intake and exhaust vents are not blocked. Adequate space should be provided between the items inside the unit to allow air circulation. And always install the stainless plate on the bottom shelf. The operation without this plate makes the temperature distribution worse.
- Do not store any materials that can generate the corrosive gas such as sulfureted gas or gaseous chlorine in the chamber. The corrosive gas may cause failure of the products.

ALARMS AND SAFETY FUNCTIONS

The unit has the alarms and safety function as shown in the table 1 below.

Table 1 Alarms and safety functions

Alarm	Condition	Display	Buzzer	Remote contact	Safety operation
Auto-set temp. Alarm	When the chamber temp. deviates from set temp. by more than 2.5 °C. (±1.0 °C~5.0 °C changeable)	<Top screen> The current chamber temp. blinks.	Intermittent tone with delay	Alarm status with delay	---
Upper limit alarm	When the chamber temp. is higher than the upper limit temp.	-----	Continuous tone	Alarm status	Heater, fluorescent lamp OFF
Lower limit alarm	When the chamber temp. is lower than the lower limit temp.	-----	Continuous tone	Alarm status	Compressor OFF
Thermal fuse	When the chamber temp. is over 70 °C	-----	---	—	Main heater and sub-heater OFF
Thermal sensor abnormality	Input voltage is over 70 °C corresponding Input voltage is lower than -50 °C corresponding	<Top screen> “E01:Temp. sensor is opened.” “E02:Temp. sensor is shorted.”	Intermittent tone	Alarm status	Heater, fluorescent lamp, fan motor and compressor OFF
Short-circuit of SSR or compressor relay	Microcomputer determines triac/compressor relay is shorted	<Top screen> “E04:SSR or comp. relay is shorted.”	Intermittent tone	Alarm status	---
Disconnection of SSR	The heater is not energized	<Top screen> “E05:SSR is open-circuited.”	Intermittent tone	Alarm status	---
Disconnection of compressor relay	The compressor relay is not energized	<Top screen> “E06:Comp. relay is open-circuited.”	Intermittent tone	Alarm status	---
Buzzer delay	Under condition of Auto-set temp. Alarm (delay time; changeable)	-----	---	—	---
Back-up of program	During power failure	-----	---	—	Nonvolatile memory Continuous running after recovery from power failure

Alarm	Condition	Display	Buzzer	Remote contact	Safety operation
Back-up of clock function	During power failure	-----	---	—	Continuous running by battery (CR2032)
Fan lock	Fan is locked	<Top screen> “E07:Air circulating fan motor trouble.”	Intermittent tone	Alarm status	Compressor OFF and heater OFF
Protection of compressor	The protective sensor is higher than 80 °C(MIR-154) or 85 °C(MIR-254)	<Top screen> “E08:Comp. is over-heat.”	Intermittent tone	Alarm status	---
Time to replace the fan	The running time is over 75,000 hours	<Top screen> “Warning:Replace air circulating fan mot.”	---	—	---
Disconnection of compressor protective sensor	The input voltage corresponds to -50 °C or less disconnection of sensor	<Top screen> “E09:Comp.sensor is opened.”	Intermittent tone	Alarm status	Compressor OFF
Defrost sensor abnormality	The input voltage corresponds to -50 °C or less disconnection of sensor	<Top screen> “E10:Def.sensor is opened.”	Intermittent tone	Alarm status	Heater OFF
	The input voltage corresponds to 70 °C or more short of sensor	<Top screen> “E11:Def.sensor is shorted.”	Intermittent tone	Alarm status	Heater OFF
Time to replace the fan motor for compressor	The running time is over 42,000 hours	<Top screen> “Warning:Replace comp. cooling fan motor”	---	—	---
Door alarm	Door is open for 2 minutes.	<Top screen> “Door:Open”	Intermittent tone with delay	—	Heaters, fan motor OFF
Power failure alarm	At power failure. If the power supply cord is unplugged or the power switch is turned off.	-----	---	Alarm status	---

ALARMS AND SAFETY FUNCTIONS

The auto-set temperature alarm function is fitted in the temperature controller. The alarm is activated automatically when the chamber temperature deviates ± 2.5 °C (± 1.0 °C \sim ± 5.0 °C) from the set temperature.

This temperature alarm function is set automatically even if under the program operation. The alarm is activated as follows under program operation.

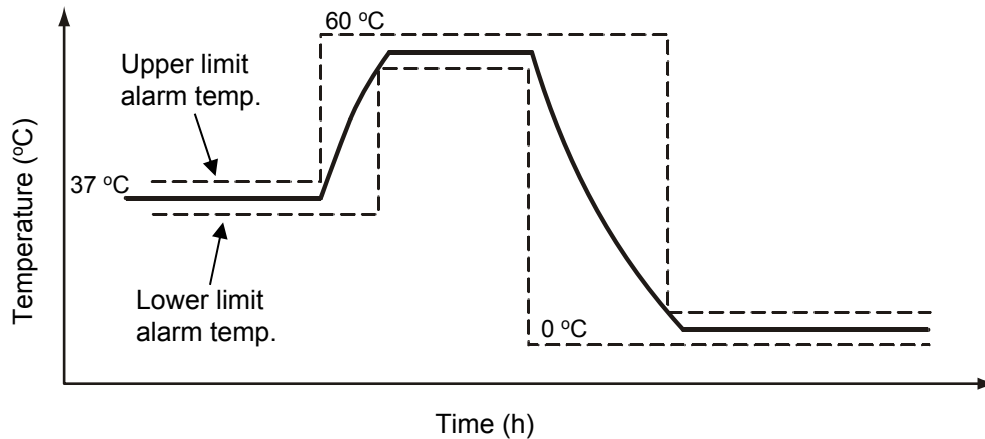

*The buzzer is stopped by pressing the alarm buzzer stop key (BUZZER), but the remote alarm keeps alarm status. The buzzer resulting from upper limit alarm and lower limit alarm cannot be silenced by the alarm buzzer stop key (BUZZER).

*The alarm may be activated when the setting of auto-set temperature alarm is small range.

MAINTENANCE

⚠️ WARNING

Always disconnect the power supply to the unit prior to any repair or maintenance of the unit in order to prevent electric shock or injury.

Ensure you do not inhale or consume medication or aerosols from around the unit at the time of maintenance. These may be harmful to your health.

Cleaning

- Clean the unit once a month. Regular cleaning keeps the unit looking new.
- Use a dry cloth to wipe off small amounts of dirt on the outside and inside of the unit and all accessories. If some of them are dirty, use a cloth containing diluted neutral dishwashing detergent (Undiluted detergent may break the plastic parts. For the dilution, follow the instruction enclosed with the detergent). When a diluted neutral dishwashing detergent is used, wipe the cabinet or accessories thoroughly with a cloth soaked in clean water. Then wipe the cabinet or accessories unit with a dry cloth to eliminate the moisture.
- Never pour water onto or into the unit. Doing so can damage the electrical insulation and may cause electric shock or short circuit.
- The compressor and other mechanical part are completely sealed. This unit requires absolutely no lubrication.
- Wipe off the condensation on the outside frame or glass with a soft dry cloth.

⚠️ CAUTION

Do not use brushes, acids, thinners, powdered soap or hot water for cleaning the freezer. Polishing powders or hot water can deteriorate the painted surfaces or cause deformation, discoloration or degeneration of plastic or rubber components. Be especially careful not to wipe plastic or rubber parts with volatile solvents such as benzine.

Cleaning of evaporating tray

The evaporating tray is located at lower left side on the back. Clean the evaporating tray twice or three times per year with water. Before removing the evaporating tray, wipe off the water in it. The procedure to remove is as follows:

1. Lift the evaporating tray and separate from the fixing plate.
2. Tilt the evaporating tray and pull out to avoid the damage to the evaporating pipe.

To replace the evaporating tray, follow the procedure in reverse.

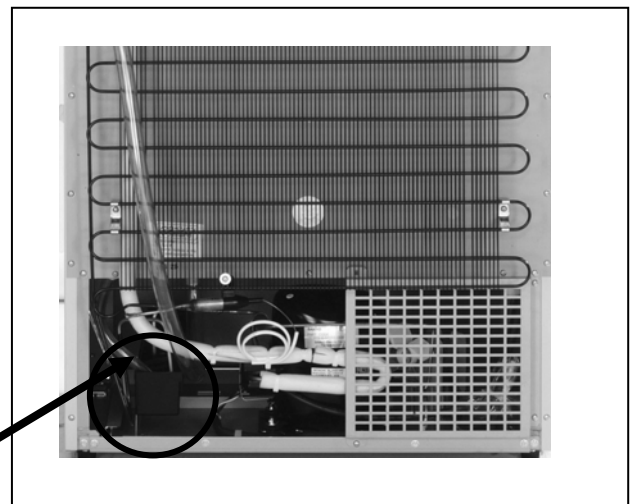

Evaporating pipe

MAINTENANCE

Replacement of lamp

Turn off the power switch and disconnect the power supply plug from the outlet.

1. Remove 2 screws fixing the shade by using a screw driver as shown in the figure.
2. Pull the lamp downward with lead wire connected.
3. After removing the water-proof rubber on the both sides, remove the socket from the lamp.
4. Attach the socket to a new lamp and then replace the water-proof rubber.
5. Replace the shade and fix with 2 screws.

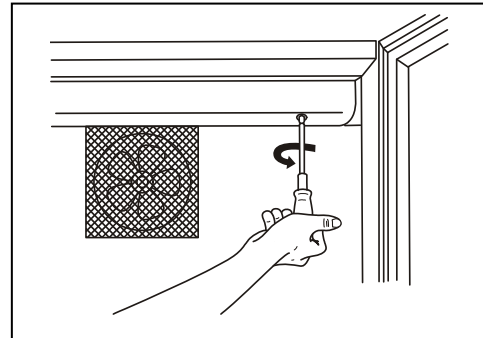

- The lamp is consumable.

Replacement of glow starter

The glow starter is located at the switch box on the upper left side.

1. Turn off the power switch and disconnect the power supply plug from the outlet.
2. Turn the glow starter to counter clockwise to remove. (See figure below)
3. Set a new glow starter. (type: FG-1P)

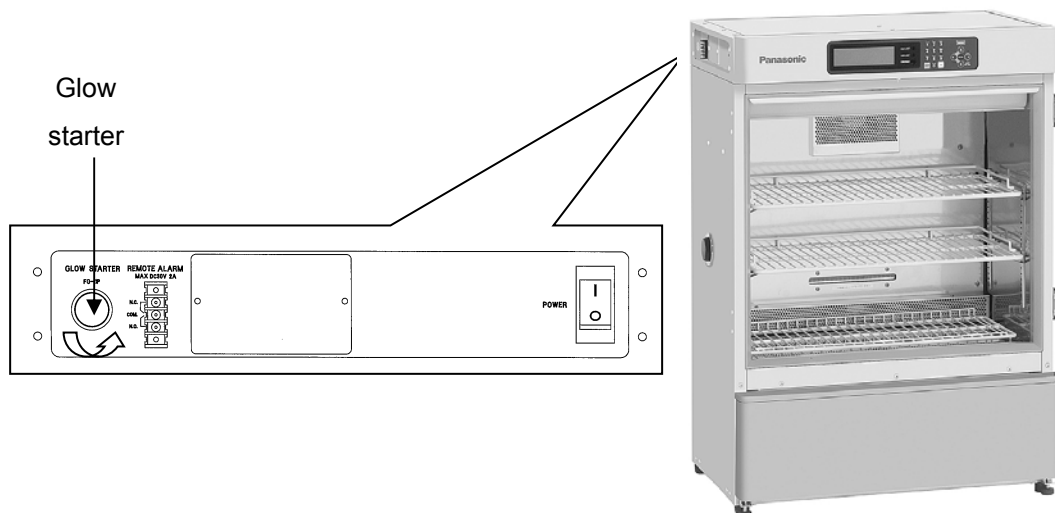

TROUBLESHOOTING

If the unit malfunctions, check out the following before calling for service. In the case of no refrigeration or poor refrigeration, transfer the stored items to another refrigerator or freezer before checking out.

Malfunction	Check/Remedy
When the buzzer sounds continuously	<p>In the event of lower limit temperature alarm</p> <ul style="list-style-type: none"> ▪ The set temperature of the chamber is lower than the lower limit temperature. <p>The lower limit temperature should be lower than the set temperature by more than 5 °C.</p> <p>Set the lower limit temperature after actual temperature of chamber reaches to the set temperature of operation.</p> <p>In the event of upper limit temperature alarm</p> <ul style="list-style-type: none"> ▪ The set temperature of the chamber is higher than the upper limit temperature. <p>The upper limit temperature should be higher than the set temperature by more than 5 °C.</p> <p>Set the upper limit temperature after actual temperature of chamber reaches to the set temperature of operation.</p> <ul style="list-style-type: none"> ▪ The excessive heat source is in the chamber. <p>Remove the excessive heat source.</p> <p>For the allowable heat load, refer to the graphs on page 59.</p>
When the program operation does not function well	<p>The chamber temperature does not change according to the program.</p> <ul style="list-style-type: none"> ▪ The incubator performance (pull-up, pull-down) is not sufficient for the program setting. ▪ The over-heat or over-cool alarm temperature is wrong. <p>These temperatures should be set 5 °C higher and lower than the upper and lower limits of the temperature controller respectively. Once excessively high/low temperature limits have been determined, the operation temperatures cannot be changed significantly due to the existence of the limits for extremes of temperature. For this reason, the excessively high/low temperature limits should be set at a wide range when the program operation is set.</p>

Note:

If the malfunction is not eliminated after checking the above items, or the malfunction is not shown in the above table, contact our sales representative or agent.

DISPOSAL OF UNIT

WARNING

If the unit is to be stored unused in an unsupervised area for an extended period **ensure that children do not have access and doors cannot be closed completely.**

The disposal of the unit should be accomplished by appropriate personnel. Always remove doors to prevent accidents such as suffocation.



*Label indication is obliged to comply with Taiwanese battery regulation.

(English)

Disposal of Old Equipment and Batteries

Only for European Union and countries with recycling systems



These symbols on the products, packaging, and/or accompanying documents mean that used electrical and electronic products and batteries must not be mixed with general household waste.

For proper treatment, recovery and recycling of old products and used batteries, please take them to applicable collection points in accordance with your national legislation.



By disposing of them correctly, you will help to save valuable resources and prevent any potential negative effects on human health and the environment.

For more information about collection and recycling, please contact your local municipality.

Penalties may be applicable for incorrect disposal of this waste, in accordance with national legislation.

Note for the battery symbol (bottom symbol):

This symbol might be used in combination with a chemical symbol. In this case it complies with the requirement set by the Directive for the chemical involved.

(German)

Entsorgung von Altgeräten und Batterien

Nur für die Europäische Union und Länder mit Recyclingsystemen



Dieses Symbol, auf den Produkten, der Verpackung und/oder den Begleitdokumenten, bedeutet, dass gebrauchte elektrische und elektronische Produkte sowie Batterien nicht in den allgemeinen Hausmüll gegeben werden dürfen.

Bitte führen Sie alte Produkte und verbrauchte Batterien zur Behandlung, Aufarbeitung bzw. zum Recycling gemäß den gesetzlichen Bestimmungen den zuständigen Sammelpunkten zu.



Indem Sie diese Produkte und Batterien ordnungsgemäß entsorgen, helfen Sie dabei, wertvolle Ressourcen zu schützen und eventuelle negative Auswirkungen auf die menschliche Gesundheit und die Umwelt zu vermeiden.

Für mehr Informationen zu Sammlung und Recycling, wenden Sie sich bitte an Ihren örtlichen Abfallentsorgungsdienstleister.

Gemäß Landesvorschriften können wegen nicht ordnungsgemäßer Entsorgung dieses Abfalls Strafgebühren verhängt werden.

Hinweis für das Batteriesymbol (Symbol unten):

Dieses Symbol kann in Kombination mit einem chemischen Symbol abgebildet sein. In diesem Fall erfolgt dieses auf Grund der Anforderungen derjenigen Richtlinien, die für die betreffende Chemikalie erlassen wurden.

DISPOSAL OF UNIT

(French)

L'élimination des équipements et des batteries usagés

Applicable uniquement dans les pays membres de l'Union européenne et les pays disposant de systèmes de recyclage.



Apposé sur le produit lui-même, sur son emballage, ou figurant dans la documentation qui l'accompagne, ce pictogramme indique que les piles, appareils électriques et électroniques usagés, doivent être séparées des ordures ménagères.



Afin de permettre le traitement, la valorisation et le recyclage adéquats des piles et des appareils usagés, veuillez les porter à l'un des points de collecte prévus, conformément à la législation nationale en vigueur.



En les éliminant conformément à la réglementation en vigueur, vous contribuez à éviter le gaspillage de ressources précieuses ainsi qu'à protéger la santé humaine et l'environnement.

Pour de plus amples renseignements sur la collecte et le recyclage, veuillez vous renseigner auprès des collectivités locales.

Le non-respect de la réglementation relative à l'élimination des déchets est passible d'une peine d'amende.

Note relative au pictogramme à apposer sur les piles (pictogramme du bas) :

Si ce pictogramme est combiné avec un symbole chimique, il répond également aux exigences posées par la Directive relative au produit chimique concerné.

(Spanish)

Eliminación de Aparatos Viejos y de Pilas y Baterías

Solamente para la Unión Europea y países con sistemas de reciclado.



Estos símbolos en los productos, su embalaje o en los documentos que los acompañen significan que los productos eléctricos y electrónicos y pilas y baterías usadas no deben mezclarse con los residuos domésticos.



Para el adecuado tratamiento, recuperación y reciclaje de los productos viejos y pilas y baterías usadas llévelos a los puntos de recogida de acuerdo con su legislación nacional.



Si los elimina correctamente ayudará a preservar valuosos recursos y evitará potenciales efectos negativos sobre la salud de las personas y sobre el medio ambiente.

Para más información sobre la recogida u reciclaje, por favor contacte con su ayuntamiento.

Puede haber sanciones por una incorrecta eliminación de este residuo, de acuerdo con la legislación nacional.

Nota para el símbolo de pilas y baterías (símbolo debajo):

Este símbolo puede usarse en combinación con el símbolo químico. En este caso, cumple con los requisitos de la Directiva del producto químico indicado.

(Portuguese)

Eliminação de Equipamentos Usados e Baterias

Apenas para a União Europeia e países com sistemas de reciclagem



Estes símbolos nos produtos, embalagens, e/ou documentos que os acompanham indicam que os produtos elétricos e eletrónicos e as baterias usados não podem ser misturados com os resíduos urbanos indiferenciados.



Para um tratamento adequado, reutilização e reciclagem de produtos e baterias usados, solicitamos que os coloque em pontos de recolha próprios, em conformidade com a respetiva legislação nacional.



Ao eliminar estes produtos corretamente estará a ajudar a poupar recursos valiosos e a prevenir quaisquer potenciais efeitos negativos sobre o ambiente e a saúde humana.

Para mais informações acerca da recolha e reciclagem, por favor contacte a sua autarquia local.

De acordo com a legislação nacional podem ser aplicadas contraordenações pela eliminação incorreta destes resíduos.

Nota para o símbolo da bateria (símbolo na parte inferior):

Este símbolo pode ser utilizado conjuntamente com um símbolo químico. Neste caso estará em conformidade com o estabelecido na Diretiva referente aos produtos químicos em causa.

(Italian)

Smaltimento di vecchie apparecchiature e batterie usate

Solo per Unione Europea e Nazioni con sistemi di raccolta e smaltimento



Questi simboli sui prodotti, sull'imballaggio e/o sulle documentazioni o manuali accompagnanti i prodotti indicano che i prodotti elettrici, elettronici e le batterie usate non devono essere buttati nei rifiuti domestici generici.



Per un trattamento adeguato, recupero e riciclaggio di vecchi prodotti e batterie usate vi invitiamo a portarli negli appositi punti di raccolta secondo la legislazione vigente nel vostro paese.



Con uno smaltimento corretto, contribuirete a salvare importanti risorse e ad evitare i potenziali effetti negativi sulla salute umana e sull'ambiente.

Per ulteriori informazioni su raccolta e riciclaggio, vi invitiamo a contattare il vostro comune.

Lo smaltimento non corretto di questi rifiuti potrebbe comportare sanzioni in accordo con la legislazione nazionale.

Note per il simbolo batterie (simbolo sotto):

Questo simbolo può essere usato in combinazione con un simbolo chimico. In questo caso è conforme ai requisiti indicati dalla Direttiva per il prodotto chimico in questione.

DISPOSAL OF UNIT

(Dutch)

Het ontdoen van oude apparatuur en batterijen.

Enkel voor de Europese Unie en landen met recycle systemen.



Deze symbolen op de producten, verpakkingen en/of begeleidende documenten betekenen dat gebruikte elektrische en elektronische producten en batterijen niet samen mogen worden weggegooid met de rest van het huishoudelijk afval.



Voor een juiste verwerking, hergebruik en recycling van oude producten en batterijen, gelieve deze in te leveren bij de desbetreffende inleverpunten in overeenstemming met uw nationale wetgeving.



Door ze op de juiste wijze weg te gooien, helpt u mee met het besparen van kostbare hulpbronnen en voorkomt u potentiële negatieve effecten op de volksgezondheid en het milieu.

Voor meer informatie over inzameling en recycling kunt u contact opnemen met uw plaatselijke gemeente.

Afhankelijk van uw nationale wetgeving kunnen er boetes worden opgelegd bij het onjuist weggooien van dit soort afval.

Let op: het batterij symbool (Onderstaand symbool).

Dit symbool kan in combinatie met een chemisch symbool gebruikt worden. In dit geval volstaan de eisen, die zijn vastgesteld in de richtlijnen van de desbetreffende chemische stof.

(Swedish)

Avfallshantering av produkter och batterier

Endast för Europeiska Unionen och länder med återvinningssystem



Dessa symboler på produkter, förpackningar och/eller medföljande dokument betyder att förbrukade elektriska och elektroniska produkter och batterier inte får blandas med vanliga hushållssopor.



För att gamla produkter och använda batterier ska hanteras och återvinnas på rätt sätt ska dom lämnas till passande uppsamlingsställe i enlighet med nationella bestämmelser.



Genom att ta göra det korrekt hjälper du till att spara värdefulla resurser och förhindrar eventuella negativa effekter på människors hälsa och på miljön.

För mer information om insamling och återvinning kontakta din kommun.

Olämplig avfallshantering kan beläggas med böter i enlighet med nationella bestämmelser.

Notering till batterisymbolen (nedanför):

Denna symbol kan användas i kombination med en kemisk symbol. I detta fall uppfyller den de krav som ställs i direktivet för den aktuella kemikalien.

LOW HUMIDITY MODE

The humidity in the chamber goes up over 90 %R.H. if the unit is running without low humidity mode when moisturized material is put inside the chamber. This may result in the condensation on the inside of the door or clearance in the chamber.

The low humidity mode is a running mode to reduce the condensation under above condition by running control with the set temperature between 20 °C and 40 °C.

Refer to page 40 for the setting of low humidity mode.

*Default setting of the low humidity mode is 0 (Not available).

[When selecting the low humidity mode]

The compressor is on/off more frequently than normal to reduce the condensation in the chamber. Accordingly, the fluctuation of the chamber humidity is more than the normal running mode.

The chamber humidity varies between about 80 %R.H. and 50 %R.H. when the chamber temperature is set to 37 °C and the ambient temperature is 20 °C.

CAUTION

The material in the chamber may be dried depending on the usage condition when the low humidity mode is selected. Do not select the low humidity mode when the drying of culture media should be avoided.

[When selecting the normal mode (no low humidity mode)]

Pay attention to the followings when the chamber temperature setting is higher than the ambient temperature with moisturized material put inside the chamber.

- The condensation may be found on the inside of the door or clearance in the chamber. Wipe off the condensation with a dry cloth.
- Because of the structure that dew saucer at door bottom receives chamber condensation, water may gathered in the saucer. Wipe off the water with a dry cloth.
- The condensation is held on the dew saucer and drained into the evaporating tray. The evaporating pipe is not heated when the compressor is off. Therefore, it is needed to clean the evaporating tray once a week.

*The amount of condensation depends on the usage condition.

CAUTION

Clean the evaporating tray regularly when selecting the normal mode (no low humidity mode). Spilled water from the evaporating tray causes the mold.

LOW COMPRESSOR VIBRATION DESIGN

To reduce the vibration of compressor in incubation purpose for example, compressor mounting base can be separated from the chamber.

Operation of the separation may cause injury, contact our sales representative or dealer when you want to reduce the vibration.

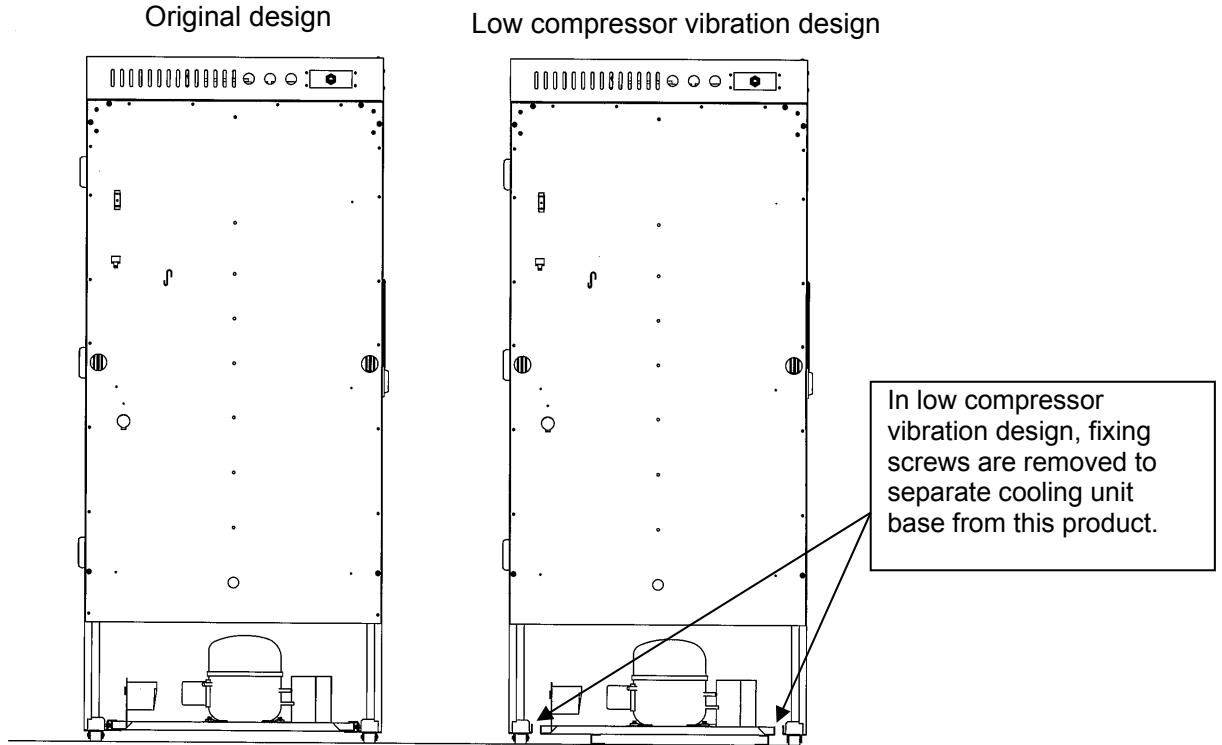

Stick the caution label packed with this product when low compressor vibration design is applied.

The refrigeration circuit is at serious risk of damage if the product is moved or relocated.

Please contact our sales representative or agent before moving this product.



PERFORMANCE DATA

Graph 1
Chamber temperature pull-down and pull-up characteristics (MIR-154)

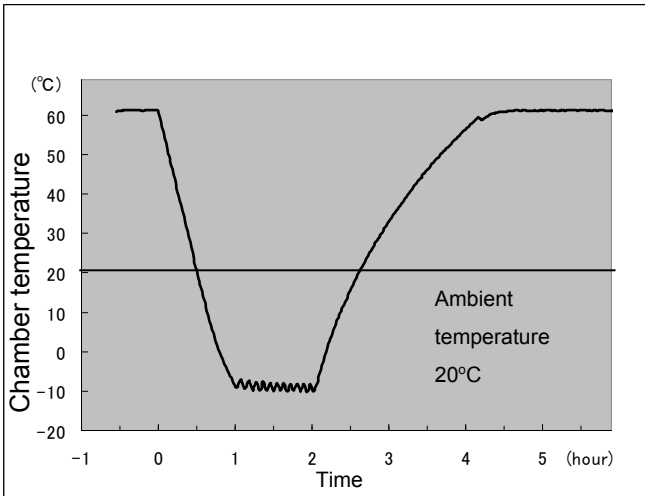

Graph 3
Relation between chamber heat load and attainable chamber temperature (MIR-154)

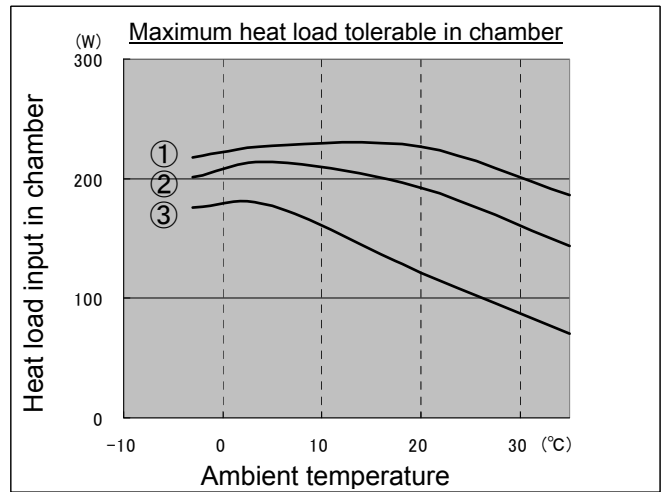

- 1 Temperature reached, in chamber, +10°C
- 2 Temperature reached, in chamber, 0°C
- 3 Temperature reached, in chamber, -10°C

Graph 2
Chamber temperature pull-down and pull-up characteristics (MIR-254)

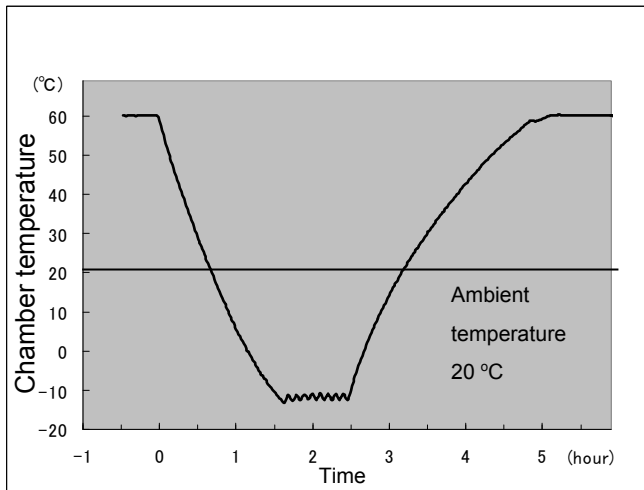

Graph 4
Relation between chamber heat load and attainable chamber temperature (MIR-254)

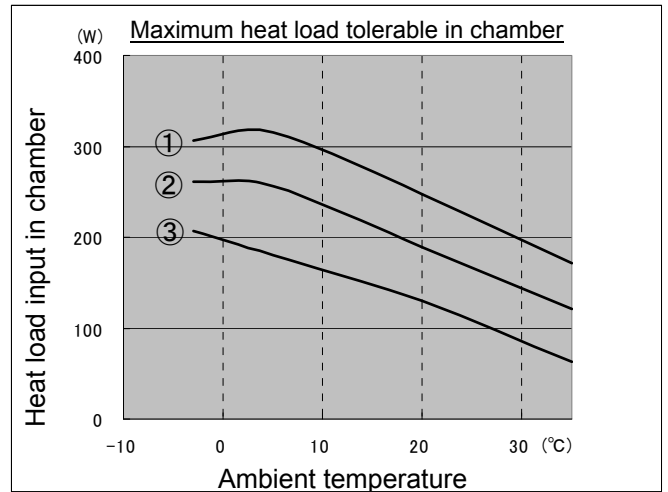

- 1 Temperature reached, in chamber, +10°C
- 2 Temperature reached, in chamber, 0°C
- 3 Temperature reached, in chamber, -10°C

Note:

- The performance data is the data with the lamp OFF.
- The performance may be varied slightly depending on each unit or running condition.

SPECIFICATIONS

Product name	Cooled Incubator MIR-154	Cooled Incubator MIR-254
External dimensions	W700 mm x D580 mm x H1018 mm (W27.56 inch x D22.83 inch x H40.08 inch)	W700 mm x D580 mm x H1618 mm (W27.56 inch x D22.83 inch x H63.7 inch)
Internal dimensions	W620 mm x D368 mm x H555 mm (W24.41 inch x D14.49 inch x H21.85 inch)	W620 mm x D368 mm x H1088 mm (W24.41 inch x D14.49 inch x H42.83 inch)
Effective capacity	123 L (4.34 cu.ft.)	238 L (8.41 cu.ft.)
Exterior	Painted steel	
Interior	Stainless steel	
Door	Painted steel	
Shelf	Polyethylene coated steel wire Inner dimensions: Upper 2 W570 mm x D300 mm (W22.44 inch x D11.81 inch) Bottom 1 W550 mm x D235 mm (W21.65 inch x D9.25 inch) Max. load: 20 kg (44.09 lb) Adjustable, 3 shelves	Polyethylene coated steel wire Inner dimensions: W570 mm x D300 mm (W22.44 inch x D11.81 inch) Max. load: 20 kg (44.09 lb) Adjustable, 5 shelves
Access port	Inner diameter 40 mm (left side)	
Insulation	Rigid polyurethane foamed-in place	
Cooling method	Forced air circulation	
Compressor	Reciprocated compressor	
	Output; 150 W	Output; 250 W
Evaporator	Fin and tube type	
Condenser	Wire and tube type	
Refrigerant	R-134a	R-404A
Defrost heater	141 W	218 W
Temperature controller	Microprocessor, PID control (compressor; ON-OFF)	
Temperature display	Digital display	
Alarm	High temp. alarm, Low temp. alarm, Independent over-heat/over-cool limiter	
Remote alarm contact	Capacity; DC 30 V, 2 A	
Program function	12 steps, 1 to 98 repeating or unlimited, Max. 10 programs memorized	
Memory backup	Nonvolatile memory	
Lamp	1 fluorescent lamp (FL15D) 15 W	
Accessories	2 rubber caps for access port, 3 shelves, 8 clips	2 rubber caps for access port, 5 shelves, 20 clips
Weight	78 kg (172 lb)	108 kg (238 lb)
Optional components	Stacking plate (for MIR-154 only; MIR-S154SB) Padlock bracket (MIR-LP), Light add on kit (MIR-L15) Glass protect plate (MIR-154BP/MIR-254BP) Interface board (MTR-L03)*, Interface board (MTR-480)*	

*Only for the Data acquisition system MTR-5000 user.

Note: Refer to the updated catalog when ordering an optional component.

Designs and specifications are subject to change without notice.

PERFORMANCE

Product name	Cooled Incubator MIR-154			
Model number	MIR-154-PT	MIR-154-PA	MIR-154-PK	MIR-154-PE
Control range	-10 °C~+60 °C (ambient temp: +5 °C~+35 °C, no load)*			
Temperature fluctuation	±1.5 °C ON-OFF control (set: 5 °C, ambient temp: 20 °C, no load) ±0.2 °C PID control (set: 50 °C, ambient temp: 20 °C, no load)			
Temperature uniformity	±0.5 °C (set: 37 °C, ambient temp.: 20 °C, no load)			
Noise level	41 dB (A scale)			
Maximum pressure	1650 kPa			
Rated voltage	AC 110 V	AC 115 V	AC 220V	AC 220 V/230 V/240 V
Rated frequency	60 Hz	60 Hz	60 Hz	50 Hz
Power consumption	150 W	160 W	145 W	130 W/135 W/140 W
Environmental conditions	Ambient temperature: +5 °C~+35 °C, Humidity: less than 80 %R.H.			

Product name	Cooled Incubator MIR-254			
Model number	MIR-254-PT	MIR-254-PA	MIR-254-PK	MIR-254-PE
Control range	-10 °C~+60 °C (ambient temp.: +5 °C~+35 °C, no load)*			
Temperature fluctuation	±1.5 °C ON-OFF control (set: 5 °C, ambient temp: 20 °C, no load) ±0.2 °C PID control (set: 50 °C, ambient temp: 20 °C, no load)			
Temperature uniformity	±0.5 °C (set: 37 °C, ambient temp.: 20 °C, no load)			
Noise level	44 dB (A scale)			
Maximum pressure	2395 kPa			
Rated voltage	AC 110 V	AC 115 V	AC 220V	AC 220 V/230 V/240 V
Rated frequency	60 Hz	60 Hz	60 Hz	50 Hz
Power consumption	220 W	240 W	215 W	190 W/195 W/200 W
Environmental conditions	Ambient temperature: +5 °C~+35 °C, Humidity: less than 80 %R.H.			

* The lighting is available only with temperature range between +2 °C and +50 °C when the optional light add on kit (MIR-L15) is installed. In the case of temperature out of range, the lighting is not usable.

Note:

The unit with CE mark complies with EU directives.

Each data of this product is measured by our standard.

All the described performances are applied for the rated supply voltage and the frequency.

Design or specifications will be subject to change without notice.

⚠ CAUTION

**Please fill in this form before servicing.
Hand over this form to the service engineer to keep for his and your safety.**

Safety check sheet

1. Incubator contents :

- Risk of infection: Yes No
Risk of toxicity: Yes No
Risk from radioactive sources: Yes No

(List all potentially hazardous materials that have been stored in this unit.)

Notes :

2. Contamination of the unit

Unit interior

- No contamination Yes No
Decontaminated Yes No
Contaminated Yes No

Others:

3. Instructions for safe repair/maintenance/disposal of the unit

- a) The unit is safe to work on Yes No
b) There is some danger (see below) Yes No

Procedure to be adhered to in order to reduce safety risk indicated in b) below.

Date :

Signature :

Address, Division :

Telephone :

Product name: Cooled Incubator	Model No. MIR-	Serial number:	Date of installation:
-----------------------------------	-------------------	----------------	-----------------------

Please decontaminate the unit yourself before calling the service engineer.

PHC Corporation

1-1-1 Sakada, Oizumi-machi, Ora-gun, Gunma 370-0596, Japan

© PHC Corporation 2018

Printed in Japan
LDCL043000-0
S0418-0