



Cabinets
Pharma Care Series
User Manual and Warranty



CONTENTS

1.	INTRODUCTION	1
1.1	Intended use	2
2.	SAFETY INSTRUCTIONS	3
2.1	Symbols	3
3.	LABELLING	4
3.1	Technical label	4
4	RECEIPT AND INSPECTION	5
5	INSTALLATION	5
5.1	Location	5
5.2	Environmental operating conditions	6
5.3	Environmental conditions for transportation and storage	6
5.4	Unpacking	6
5.5	Electrical connection	6
5.6	Battery	7
5.7	Levelling	8
5.8	Rubber gasket	9
5.9	Remote Alarm Installation	9
5.10	Final Check-up	9
5.11	Cleaning and Disinfection	9
6	DRAWERS (OPTIONAL in PER07S, PER07G, PER15S, PER15G, PER36S and PER36G)	11
6.1	Removing the Drawers	11
6.2	Reinstalling the Drawers	11
6.3	Changing the position of the drawers	11
7	DIGITAL CONTROL	13
7.1	Front panel	13
7.2	The display screen	13
7.3	Unlocking the keyboard	14
7.4	Changing the Set Point	14
7.5	Manual defrost	14
7.6	Changing parameters	14
7.7	Turning the equipment on and off	15
7.8	Alarms	15
8	TEMPERATURE MONITORING	17
8.1	Set Point Control	17
8.2	Product Simulation Temperature Probe (Optional)	17
9	MAINTENANCE, CLEANING, AND CARE	18
9.1	Cleaning Procedure	18
9.2	Battery Replacement	19
9.3	Spare Parts and Technical Support	20
10	TROUBLESHOOTING	21
11	USEFUL LIFE OF THE EQUIPMENT	23
11.1	End of useful life	23
12	TEMPERATURE CHART RECORDER (OPTIONAL)	24
13	WARRANTY	25
13.1	Warranty certificate	26

1. INTRODUCTION

Pharmaceutical refrigerators are designed to strictly meet the requirements necessary to operate in pharmacies.

Pharmaceutical refrigerators are classified as CLASS I (Protection against electric shock) and a mode of CONTINUOUS OPERATION according to UNE_EN_60601.

This product has been manufactured under strict quality controls and meets all the requirements established by Infrico. Each unit has been tested and its quality is ensured before being shipped. This equipment has been manufactured with recyclable materials, by means of an environmentally friendly production process.

MODELO MODEL	Capacidad Bruta (litros) Gross Capacity (liters)	Medidas Exterior (mm) Exterior dimensions (mm)	Medidas Interior (mm) Interior dimensions (mm)	Claro de puerta (mm) Door opening (mm)	Nº Estantes Shelves Number	Dimensiones Estante (LxP) Shelf size (LxD)
PER07S	58	445 x 526 x 818	358 x 312 x 523	358 x 516	2	315 x 248
PER07G	60	445 x 508 x 818	358 x 323 x 523	358 x 516	2	315 x 248
PER16S	141	600 x 688 x 824	505 x 451 x 617	505 x 552	3	458 x 398
PER16G	141	600 x 680 x 824	505 x 455 x 617	505 x 552	3	458 x 398
PER24S	236	600 x 688 x 1244	505 x 451 x 1037	505 x 972	4	458 x 398
PER24G	238	600 x 680 x 1244	505 x 455 x 1037	505 x 972	4	458 x 398
PER28S	327	600 x 688 x 1644	505 x 451 x 1437	505 x 1372	5	458 x 398
PER28G	330	600 x 680 x 1644	505 x 455 x 1437	505 x 1372	5	458 x 398
PER37S	373	600 x 688 x 1844	505 x 451 x 1637	505 x 1572	6	458 x 398
PER37G	376	600 x 680 x 1844	505 x 455 x 1637	505 x 1572	6	458 x 398
PTR30ISD	313	595 x 621 x 1876	483 x 426 x 1521	483 x 1311	7	418 x 398
PTR30IGD	328	595 x 621 x 1876	483 x 446 x 1521	483 x 1311	7	418 x 398
PTR40ISD	398	670 x 683 x 1963	568 x 484 x 1338	568 x 1280	7	500 x 443
PTR40IGD	413	670 x 683 x 1963	570 x 504 x 1338	568 x 1280	7	500 x 443
PTR65ISD	506	687 x 870 x 1955	534 x 633 x 1207	534 x 1350	7	452 x 585
PTR65IGD	521	687 x 870 x 1955	534 x 654 x 1207	534 x 1350	7	452 x 585
PTR80ISD	719	797 x 1000 x 1955	645 x 803 x 1388	645 x 1350	7	564 x 750
PTR80IGD	737	797 x 1000 x 1955	645 x 823 x 1388	645 x 1350	7	564 x 750
PTR130ISD	1166	1385 x 834 x 1955	1234 x 681 x 1388	534 x 1350	14	452 x 585
PTR130IGD	1202	1385 x 834 x 1955	1234 x 702 x 1388	534 x 1350	14	452 x 585

Temperature range of the equipment:	2 °C to 8 °C (35,6°F a 46,4°F)
Accuracy:	± 0.1 °C (±0,2°F)
Display error values:	±0.2 °C (±0,4°F)

Please read this manual carefully before installing your new device to become familiar with all of its advantages.



OBLIGATION! This device must be used only for the purpose described in this manual.

1.1 Intended use

Our equipment is designed for the storage and preservation of pharmaceutical products at a temperature range of 2 °C to 8 °C. (35,6°F a 46,4°F)

2. SAFETY INSTRUCTIONS

In this manual and on the labels of this product, the terms Warning and Caution convey the following meaning:

- Warning: A potentially hazardous situation which, if not avoided, could result in serious injury or death.
- Caution: A potentially hazardous situation which, if not avoided, may result in minor or moderate injury or damage to equipment.

Please read this manual and the product labels carefully before installing or using this product. Failure to follow these instructions may cause the product to malfunction, which may result in injury or damage.

The use of electrical devices implies the implementation of basic safety instructions such as:

- Follow the recommendations in this manual to properly locate and place this device prior to installation.
- Do not allow children to handle the device, as they could damage it, or themselves, seriously.
- Do not touch the cold surfaces of the freezing devices, as such surfaces may adhere to skin.
- Do not store or use flammable products near the device.
- Unplug the device before any cleaning, repair or maintenance operation.



WARNING! Any manipulation of the device must be carried out by an authorised technical support service provider.



WARNING! 'No modification is permitted on this equipment.'



WARNING! We inform you that the person installing the device is responsible for carrying out the installation as instructed in the user manual.



WARNING! We remind you that you are responsible for the proper maintenance of the equipment. The manufacturer is not to be held liable for issues resulting from improper maintenance.

2.1 Symbols



WARNINGS



OBLIGATION



3. LABELLING

In our equipment, labels are attached to the inside of the products. Their exact location is the top inner left side.

3.1 Technical label



CTRA. DE AGUILAR A A -318 POR
MORILES KM 15,5 – A-3132



PER16G



MADE IN SPAIN

MFG. DATE 04/11/2022
FECHA FAB.

ALIMENTACIÓN POWER SUPPLY	230 V	I	50 Hz	INTENSIDAD TOTAL AMPS	0,58 A
POTENCIA POWER		112 W		REFRIGERANTE REFRIGERANT	R600a
RES. ANTIVAHO ANTI-SWEAT HEATER		W		CARGA REFRIG. REFRIG. MASS	45 gr
BANDEJA EVAPOR EVAPORATION TRAY		W		ESPUMANTE BLOWING AGENT	HFO
OTRAS RESIST. OTHER HEATERS		W		PODER CONGELACIÓN	KG/24H
ILUMINACIÓN LIGHTING		4 W		VOLUMEN ÚTIL NET CAPACITY	141 L
CONSUMO ENERG ENERGY CONSUM		KWH/24H		CLASE CLIMATICA CLIMATIC CLASS	4

4 RECEIPT AND INSPECTION

- All Infrico products are factory tested to assess their quality and performance and are shipped free of defects.
- When you receive your device, it should be carefully examined for any damage that may have incurred during transportation.
- If any damage is detected on the unit, you must retain all packaging material and report such damage on the carrier's bill of lading. A claim must be immediately made to the transport company.
- If the damage is found during or immediately after installation, contact your distributor immediately.



WARNING!: Infrico is not to be held liable for any damage caused during transport.

5 INSTALLATION

5.1 Location

This device is intended for indoor use only.

Be sure the location chosen for your unit must be able to provide good air circulation efficient refrigeration.

Avoid locations near heat sources, such as sunny windows, ovens, heaters, as well as direct solar radiation where temperatures can reach extreme values. In addition, do not choose a location in areas where temperatures drop below 12 °C or rise above 32 °C.

You should allow enough clearance between the equipment and the side walls so that the 120° door-opening lock can be used. Doors require a minimum angle of 90° to open properly, in order to use the maximum door width available.

The surface of the final location where the device is to be placed must be strong enough to support the total weight of the device considering its full maximum load capacity. In addition, it must be levelled and free of vibrations. Reinforce the flooring if necessary.



WARNING!: Do not place the equipment so that it is difficult to operate on the disconnecting device (power cord peg).

5.2 Environmental operating conditions.

Laboratory refrigerators are designed to be safe under the following conditions.

- Indoor use
- Altitude up to 2000 m (795 mbar)
- Temperatures from 12 °C to 32 °C (53,6°F to 89,6°F)
- Maximum Relative Humidity: 65 %
- Voltage fluctuations in mains of up to ± 10 % of the nominal voltage.

5.3 Environmental conditions for transportation and storage.

Laboratory refrigerators are designed to be safe under the following transportation conditions.

- Storage temperature: from -15 °C (5°F) to 55 °C (131°F)
- Relative humidity: 20 - 85 % (non-condensing)

5.4 Unpacking

The devices are shipped from the factory on a wooden pallet and are packed in sturdy wooden/cardboard boxes. The box is screwed to the wooden base. The screws must be removed prior to unpacking to avoid damage to the unit.

All packaging materials are environmentally friendly and should be reused or recycled. Actively contribute to the protection of the environment by demanding recyclable packaging and environmentally friendly disposal methods.



WARNING: Infrico does not recommend knocking the unit forward, sideways or backward. However, if this occurs, you must ensure that the unit remains in an upright position for at least 24 hours before connecting it, so that the compressor oil returns to the compressor.

5.5 Electrical connection



WARNING!: Connect the equipment to a dedicated outlet with the correct voltage for the device. Incorrect power or voltage fluctuations can cause serious damage to the equipment.

The equipment is prepared for power supply 220-230V 50 Hz, 220-230V 60 Hz, 115V, 60Hz. The equipment has a hose and plug installed in the factory. Check the adhesive on the power cord. If you do not have the proper outlet, you must install it beforehand. The means to isolate the equipment from the power supply network is the plug of the power cable.

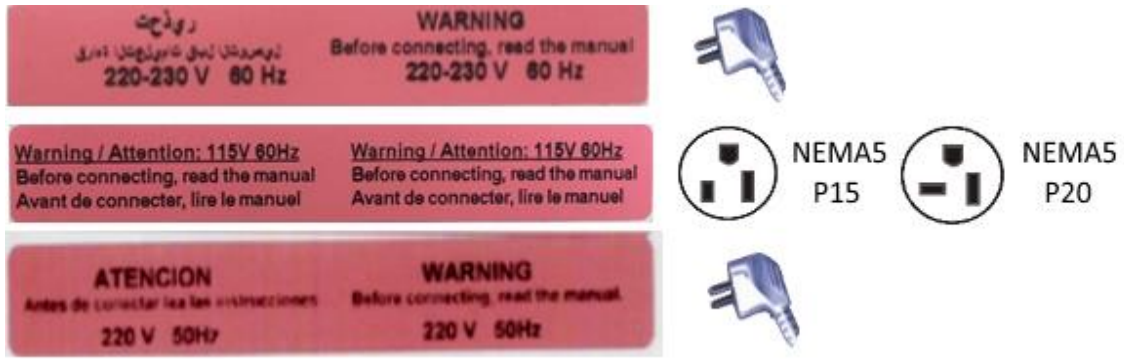

WARNING! This unit must be grounded before use in order to ensure personal safety and the proper operating of the equipment. A grounding fault may cause damage to personnel or equipment. Always comply with the National Electrical Code. Do not connect the equipment to power lines that are already overloaded.



OBLIGATION: The device must be connected to an exclusive dedicated circuit. Failure to comply with this requirement shall void the warranty.



WARNING! The device is designed to tackle a voltage fluctuation of around 10 % in relation to the rated voltage indicated in the rating plate. A compressor fault due to higher fluctuations shall automatically void the warranty.

Note: It is recommended to install a UPS (Uninterruptible Power Supply) or other system to avoid voltage peaks or lack of electric current supply.



WARNING! If the hose or the peg are altered in any way, they may constitute a serious hazard. Any alteration of these components shall void the warranty.



WARNING: Devices connected to an extension cord are not covered by Infrico's warranty.



WARNING: The power cable can only be replaced by an authorized technical support service provider.

5.6 Battery

The equipment is equipped with a 12V-12Ah rechargeable lead-acid battery. (Except the models PER07S/PER07G/LER07S/LER07G, which are with a 12V-7Ah rechargeable lead-acid battery).

Once the equipment has been installed, it must be connected by an approved installer. Follow the instructions below.



UBICACIÓN DE BATERÍA BATTERY LOCATION

**Por favor, conecte el interruptor de la batería al enchufar el equipo.
Please, turn on the battery switch after installing the equipment.**

La ubicación del interruptor de batería depende del modelo. Para conocer su ubicación, vea las siguientes imágenes:
The location of the battery switch depends on the model. For the location, see the following pictures:

MODELO / MODEL: PER 17

Respaldo del equipo / Back side

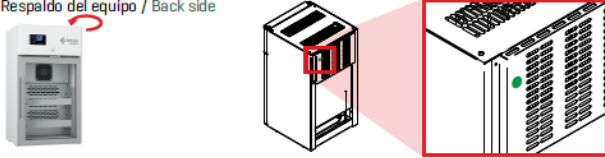

MODELO / MODEL: PER 16/24/28/37 - PTR 30/40 - LTUF 25/40 - BBMD 17/25/40

Parte inferior del cuadro de mandos / Lower side of the control panel



MODELO / MODEL: PTR 65/80 - LTUF 65/80 - BBMD 65/80

Parte trasera caja de conexiones / Rear side of the connection box

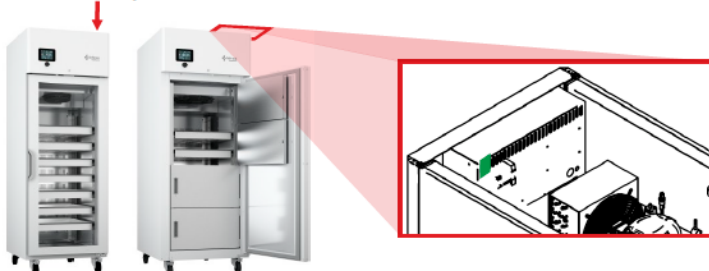

**Por favor, desconecte el interruptor de la batería al desenchufar el equipo.
Please, disconnect the battery switch after unplugging the equipment.**

www.infricomedicara.com | info@infricomedicara.com | sat.medicara@infrico.com
 Tel: (0034) 957 59 51 14 | Tel: (0034) 609 50 25 97 | Tel: (0034) 696 08 29 26 (Ext: 4145)
 Ctra. de Aguilera A-318 por Moriles Km 15.5, A-3132 | 14900 Lucena (Córdoba) Spain





WARNING! Disconnect the battery switch after unplugging the equipment or in case of power failure
The warranty does not cover battery replacement due to discharge due to this circumstance.



WARNING! For battery replacement see Section 9.2.

5.7 Levelling

It is very important that the device is perfectly levelled for proper operation, so that it drains properly, the doors are aligned, and the unit is not subjected to undue stress.

These models are shipped from the factory with adjustable legs. In this case, adjust them until the unit is completely stable and levelled.

Optionally, the units can be shipped with non-adjustable wheels for all models. In this case, you must ensure that the floor where the unit will be located is levelled. The front wheel brakes must be locked for stable operation.

5.8 Rubber gasket

To verify that the door is sealed, follow the steps below:

1. Opening the door.
2. Insert a strip of paper between the rubber gasket and the rubber gasket profile, and close the door.
3. Slowly remove the paper strip from the outside. While doing so, you should feel a little resistance.
4. Repeat this operation at 10 cm intervals covering the entire door frame. If the door does not close properly, the gasket needs to be replaced or the door needs to be adjusted.



CAUTION! Hermetic door sealing is essential for blood bank refrigerators to function properly. Faulty sealing allows humid air inside the device, which results in the accumulation of moisture in the evaporator, resulting in poor temperature maintenance, increased operating time, and increased operating costs.

5.9 Remote Alarm Installation

All models of pharmaceutical refrigerators have a remote alarm connection that is located in the back of the equipment



5.10 Final Check-up

Before commissioning the device, follow the steps below:

1. Make sure the unit is free of all wood or cardboard packaging materials, both on the inside and outside.
2. Verify the position of the stainless steel drawers. If you want to adjust the height of the drawers, follow the instructions in section 6.3.
3. Verify that the unit is connected to a dedicated outlet.

5.11 Cleaning and Disinfection

Before commissioning the device, clean and disinfect it to remove any metal, plastic, sticker or residue left.

Use water with a neutral detergent and dry properly.



CAUTION! Do not use a brush, acid, diluent, laundry soap, washing powder or boiling water to clean the device.

These may damage the painted surface, as well as the stainless steel surface, or the plastic and rubber components. Also, do not clean plastic and rubber components with a volatile material.

6 DRAWERS (OPTIONAL in PER07S, PER07G, PER15S, PER15G, PER36S and PER36G)

6.1 Removing the Drawers

To remove the drawers, complete the following steps:

1. Pull the drawer towards you until the slide rails are fully extended.
2. Press on the back of the side clips to unlock the drawer lock.
3. Lift the front of the drawer and pull it back to remove it.



6.2 Reinstalling the Drawers

To reinstall the drawers, complete the following steps:

1. Insert the drawer in the side slide rails tilting it at about 45°. Once it is fit on the rails, place it in a horizontal position.
2. Press on the front of the side clips to lock the drawer latch.
3. Insert the drawer all the way in.

6.3 Changing the position of the drawers

The drawer slide rails are height adjustable. You can place these rails in the vertical slits that are spaced at intervals of 50.

To change the position of the drawer slide rails, complete the following steps:

1. Pull the front of the slide rail upwards until the front flap comes out of its place.
2. Then pull the slide rail forwards until the rear flap comes out of its place too.
3. Change the height as desired by following the steps in reverse to put the slide rail back in place.



7 DIGITAL CONTROL



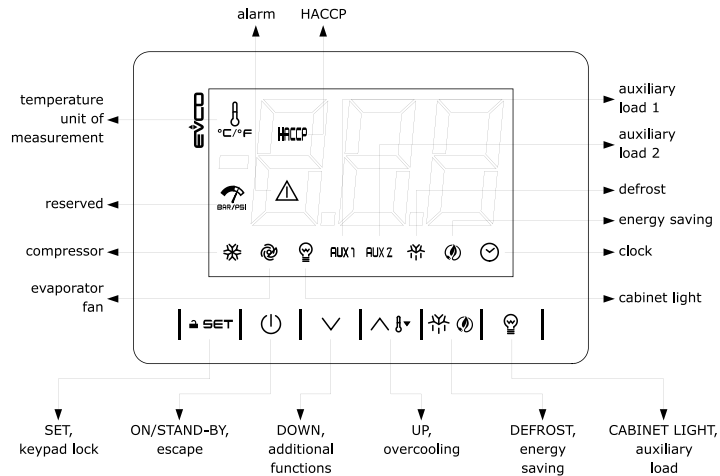

7.1 Front panel



7.2 The display screen

The following icons appear on the screen:

LED	ON	OFF	FLASHING
	compressor ON	compressor OFF	- Compressor protection activated - Setpoint setting
	Evaporator fan ON	Evaporator fan OFF	Fan shutdown activated
	Interior light ON	Interior light OFF	Interior light activated via digital input



AUX 1	Auxiliary function 1 ON	Auxiliary function 1 OFF	- Auxiliary function 1 via digital input - Auxiliary function 1 via digital input
AUX 2	Auxiliary function 2 ON	Auxiliary function 2 OFF	- Auxiliary function 2 via digital input - Auxiliary function 2 - delay activated
	Defrost or pre-dripping activated	-	- Defrost delay activated - Dripping time enabled
	- Energy saving activated - Low power activated	-	-
	View time	-	date, time and day of the current week setting
	View temperature	-	Fast refrigeration activated
HACCP	recording of HACCP alarms	-	new HACCP alarm saved
	Alarm activated	-	-

7.3 Unlocking the keyboard

Press any key for 1 second: The screen shows the unlocking message 'UnL'.

7.4 Changing the Set Point

Check that the keyboard is unlocked.

	Press the SET key.
	Press the up or down key to set a value within the r1 and r2 limits.
	Press the Set key (or do not press for 15 s).









7.5 Manual defrost

Check that the keyboard is unlocked, and that quick refrigeration is not active.

	Press the Defrost key for 2 s.
---	--------------------------------

If P3 = 1 (by default), defrost is activated whenever the evaporator temperature is below limit d2.

7.6 Changing parameters

	Press the SET key for 4 seconds: the screen will show the message 'PA'.
	Press the SET key.
	Press the up and down keys to enter the password (by default '-19').
	Press the Set Key (or do not press for 15 s). The screen will display the message 'SP'.
	Press the up and down keys to select a parameter.
	Press the SET key.
	Press the up and down keys to select a value.
	Press the Set key (or do not press for 15 s).
	Press the SET button for 4 seconds (or do not press for 60 s) to end the process.

7.7 Turning the equipment on and off

 | If POF = 1 (by default), press the ON/STAND-BY key for 2 seconds.

If the device is turned on, the screen will display the value P5 ('Temperature inside chamber'); if the screen displays any alarm code, go to section 5.8 'Alarms'.

7.8 Alarms

CODE.	DESCRIPTION	RESTART	TO CORRECT
Pr1	Chamber probe alarm	automatic	- check P0
Pr2	Evaporator probe alarm	automatic	- check the status of the probe
Pr3	Auxiliary probe alarm	automatic	- check the electrical connection
rtc	Clock alarm	manual	Set date, time and day of the week
AL	Low temperature alarm	automatic	check A0, A1 and A2
AH	High temperature alarm	automatic	check A4 and A5
id	Door open alarm	automatic	check i0 and i1
PF	Power fault alarm	manual	- Press a key - Check the electrical connection
COH	High condensation warning	automatic	check C6
CSd	High condensation alarm	manual	- Turn the device off and on again - check C7
iA	Multifunction input alarm	automatic	check i5 and i6
iSd	High pressure alarm	manual	- Turn the device off and on again - check i5, i6, i8, i9
LP	Low pressure alarm	automatic	check i5 and i6
C1t	Compressor thermal switch alarm	automatic	check i5 and i6

C2t	Second compressor thermal switch alarm	automatic	check i5 and i6
dFd	End defrost time alarm	manual	- Press a key - check d2, d3 and d11
FUL	Full SD card alarm	manual	Free up space in the SD memory or replace the card.
Sd	SD card missing alarm	manual	Insert SD card or replace it.

8 TEMPERATURE MONITORING

8.1 Set Point Control

Your unit has been factory set and tested to maintain a chamber temperature of -18°C . For most laboratory applications, you will not need to change the temperature set point.

The chamber set point value is calculated according to the cut-off service parameters and a differential.

To adjust the set point:

- 1.- Access the service parameters as shown in section 7.6.
- 2.- Adjust the cut-off values and differential as necessary.

8.2 Product Simulation Temperature Probe (Optional)

The temperature of the chamber is measured by means of two probes inserted in a pot, placed on the side as shown in the image. The pot contains 5% glycerine and 95% water to simulate samples of vaccines and / or medications. Keep the sensor canister completely filled to the top.



9 MAINTENANCE, CLEANING, AND CARE

9.1 Cleaning Procedure

Periodic cleaning of the device

To clean the device, follow the instructions below:

- Disconnect the equipment from the mains and remove all products stored in it.
- Open all doors and allow time for the interior to reach room temperature. Remove all interior accessories and clean them with soap and lukewarm water. Dry all accessories completely with a soft cloth.
- Once the chamber has reached room temperature, clean all interior and exterior surfaces with soapy water. Rinse thoroughly and dry with a soft cloth. Failure to dry the device properly may result in water stains. Stainless steel cleaners are also available in the market, which can repair and protect the protective layer of steel surfaces.
- Put the accessories back in place and connect the unit to the mains.
- Pitting corrosion or cracks in steel are signs of material deterioration. In this case, apply stainless steel cleaners capable of repairing the steel passivation.



WARNING: Never use steel scrubbers, wire brushed or spatulas to clean the device.



NOTE: Cleaning products used must be alkaline-based or chlorine-free. Any cleaner containing chlorides will damage the protective layer of the stainless steel.

Rubber gaskets maintenance



- Rubber gaskets require regular cleaning to protect their elasticity, to ensure proper sealing, and prevent mould growth. Rubber gaskets can be cleaned with soapy water. Avoid using abrasive cleaners or sharp utensils.
- Rubber gaskets can be easily removed in case replacement is needed by pressing them against the door frame.

Cleaning of the condenser

The condenser, located behind the back grille of the device, should be checked regularly. Cleaning frequency will depend on the working environment. Air must flow freely through the condenser, so its surface must be free of dirt and grease. Dirty condensers cause compressor fault and product loss. If the condenser battery is dirty or blocked, follow the steps below:

- Disconnect the device from the mains.
- Remove the back grille from the unit.
- On some models, it will be necessary to remove the screws that affix the condensing unit to the skirting board and remove it in order to clean the condenser.
- If the condenser has a protective case, it must be unscrewed and removed.
- Once the surface of the condenser is accessible, it should be cleaned using a vacuum cleaner or a soft brush. Do not use metal brushes.
- If the dirt is excessive, compressed air can be used for cleaning.
- After cleaning, reinsert the protective case, return the condensing unit to its original position, and re-attach all screws.
- Finally, replace the rear grille and connect the device to the mains.



WARNING! Do not use water to clean the condenser, as it may damage nearby electrical components.

Maintenance of doors / hinges

Over time and due to normal wear, door hinges may move off place slightly. If you notice that the door is not properly aligned, tightened the screws that attach the hinge brackets to the cabinet.

9.2 Battery Replacement



OBLIGATION!: Make sure the device is disconnected from the mains before carrying out any maintenance or repair work.

The equipment consists of a 12V-12Ah Lead-Acid rechargeable battery. Battery should be replaced only with another one of the same characteristics as mentioned above.



PROHIBITION!: The battery may only be replaced by an authorised technical support service provider.

9.3 Spare Parts and Technical Support

OBLIGATION!: Make sure the device is disconnected from the mains before carrying out any maintenance or repair work.

If there is no recommended technical support service provider in your area, please contact us for a list of technical support service providers.

If the problem persists after the appropriate verifications, **DO NOT MAKE ANY REPAIRS YOURSELF.** Contact our Technical Support Service, and have the model and serial number of the device at hand (located on the technical data label),



WARNING!: If spare parts are needed, always insist on factory authorized spare parts.

Note: Wiring diagrams, exploded view diagrams, descriptions, calibration instructions and other information regarding the equipment are available upon request to assist the authorized technical support service provider in a repair.

10 TROUBLESHOOTING

Many operational issues derive from causes that can be easily eliminated without the need to contact the Technical Support Service. The following list covers several types of issues and how to solve them.

ISSUE	CAUSE
The device does not work	<ol style="list-style-type: none"> 1. The plug is not connected to the power outlet. 2. The plug is not carried with power because the fuse has blown or the automatic current limiter has tripped.
The device does not cool sufficiently	<ol style="list-style-type: none"> 1. Check the setpoint temperature on the controller. 2. Door not properly closed or frequent openings. 3. Obstruction of the ventilation grilles of the device. 4. Condenser dirty. 5. The device is exposed to direct sunlight or another heat source.
Noisy operation	<ol style="list-style-type: none"> 1. The device has not been correctly levelled. 2. Some of the tubes inside the device are rubbing against each other. 3. Loose screws on any of the parts. 4. Fan in condenser or evaporator causing vibrations. 5. Loose parts in the condensing unit.
The device creates excessive ice in the evaporator	<ol style="list-style-type: none"> 1. Doors not properly closed. 2. Excessive door openings. 3. Defrost has not been carried out.
Compressor does not start	<ol style="list-style-type: none"> 1. Opened switch. 2. Blown fuse. 3. Faulty wiring. 4. Opened Clixon. 5. Opened controller contacts (defective controller, or device located in a too cold area). 6. Defective relay. 7. Low gas load in the system - check for leaks.
Compressor starts, but it shuts down due to overload	<ol style="list-style-type: none"> 1. Low voltage. 2. Faulty wiring. 3. Defective start capacitor. 4. Sealed start condenser. 5. Defective compressor. 6. High condensation pressure.

<p>High Condensation Pressure</p>	<ol style="list-style-type: none"> 1. Overloaded unit. 2. Air or non-condensable gases in the system. 3. Condenser dirty. 4. Defective condenser fan. 5. Device located in a too hot area. 6. Obstruction in expansion valve or filter. 7. Discharge valve partially closed. 8. Discharge line obstruction.
<p>Reduced Condensation Pressure</p>	<ol style="list-style-type: none"> 1. Insufficient refrigerant load. 2. Leaks in the system. 3. Device located in a too cold area.
<p>The compressor performs short cycles</p>	<ol style="list-style-type: none"> 1. Differential control set at too short intervals. 2. Low refrigerant load, check the pressure. 3. Excessive refrigerant load. 4. Leaks in the discharge valve. 5. Opened high pressure switch. 6. Condenser dirty.
<p>Too long operating cycles, or continuous operation of the unit</p>	<ol style="list-style-type: none"> 1.- Insufficient refrigerant load. 2.- Obstructed or dirty condenser. 3.- Device located in a too hot area. 4.- Controller relay glued. 5.- Air or non-condensable gases in the system. 6.- Defective or incorrectly adjusted expansion valve. 7.- Doors have remained open for too long. 8.- Insufficient or defective insulation, or saturated with water. 9.- Excess of oil in the evaporator.

11 USEFUL LIFE OF THE EQUIPMENT

Our equipment has been designed for a useful life of approximately 20 years, considering the availability of spare parts and that, after reaching that point in time, we assume that the cost of repairing it may be higher than purchasing a new one.

11.1 End of useful life

The symbol and the recycling systems described below apply to countries within the European Union and do not apply to countries in other areas of the world.

Your Infrico product was designed and manufactured with high quality materials and components that can be recycled and/or reused.

The symbol means that electrical and electronic equipment, batteries and accumulators, at the end of their useful lives, must be disposed of separately from your domestic waste.

Note: If there is a chemical symbol printed below the symbol, this chemical symbol means that the battery or accumulator contains a certain concentration of a heavy metal. This is indicated as follows: Hg: mercury, Cd: cadmium, Pb: lead

Within the European Union there are separate collection systems for electrical and electronic equipment, batteries and used accumulators.



Please dispose of them properly at your local community waste collection/recycling centre.

Please help us protect the environment we live in!



WARNING!: Inform the waste manager that the equipment may contain biological remains.

12 TEMPERATURE CHART RECORDER (OPTIONAL)



All pharmaceutical refrigerators are designed to accommodate a circular chart recorder.

The location of the recorder is in the control panel of each equipment in a specific housing for this.

Set up:

- 1) Open the door with the key
- 2) Raise the boom to 90° (3)
- 3) Push the retaining clip (6) to raise the diagram
- 4) Remove the diagram (7)
- 5) Insert the battery (8) with the poles so correct, leaving The tape to facilitate its extraction.
- 6) Insert the diagram(7)
- 7) Lower the retaining clip (6) and push laterally
- 8) Lower the boom gently (3)
- 9) Manually rotate the diagram according to the day and time you want to record data (6)
- 10) Remove the protection sleeve from the pen
- 11) Close the door with key

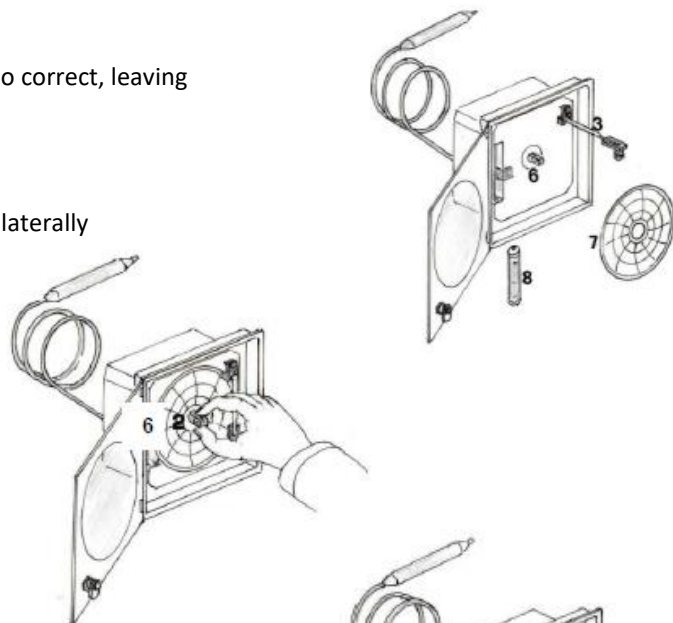

Replacing the diagram:

- 1) Push the retaining clip (6) to raise the diagram
- 2) Remove the diagram (7)
- 3) Insert the new diagram
- 4) Lower the retaining clip (6) and push laterally

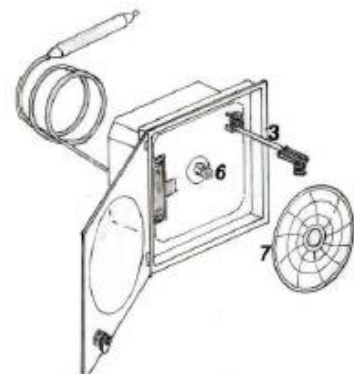

Replacing the pen:

- 1) Remove the pen carefully (4) so as not to damage the tip (3)
- 2) Place the new pen on the tip

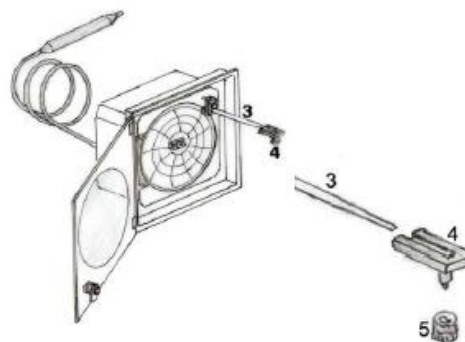

13 WARRANTY

Dear client, we would like to inform you that the products manufactured and sold by Infrico S.L. are equipment intended for industrial, non-residential use. Therefore, their warranty is not regulated by the consumer and user protection law but by the laws of commercial warranties.

- Infrico S.L.'s warranty covers any manufacturing defect or any hidden defect in the device during the period stipulated in the commercial contract. The warranty that Infrico as a manufacturer grants to its commercial network covers defective parts shipped freight paid, and it is the distributor's responsibility to cover the repair warranty (labour and consumables) and of course, the commissioning of the equipment in the first installation onsite, unless other conditions are agreed upon in the commercial contract.
- It is the responsibility of the distributors to attend to end user's warranties, ordering from Infrico S.L. all necessary components for repairs or replacements.
- The warranty does not cover breakage of glass after delivery by Infrico or parts damaged by improper use or normal wear.
- If, during the first 3 months of operation, an anomaly is detected in the device which, due to its magnitude, is disproportionate to the value of the equipment, a complete replacement of the equipment could be granted. After this period no substitution will be considered in any case.
- Any intervention on the device that affects the electrical connection, refrigerating parts or the electronic microcontroller not authorized by our technical support service shall void the warranty period remaining on the machine.
- If, exceptionally, the distributor is unable to carry out a repair, the technical support service may authorise the pickup of a machine to be repaired at Infrico S.L.'s premises to then be returned to the client. If the repair is not performed within the warranty period, the client shall be charged for the costs of such repair and transport.
- All returns authorized by the technical support service, either for repairs or replacements, are inspected at our facilities. If anomalies other than those claimed and unrelated to our manufacture or due to misuse or wear are detected, Infrico S.L. shall not be responsible for the costs of repairs or replacements that may be required, which shall be borne by the client.
- The conditions of the warranty shall not be modified unless a written agreement to modify the conditions of the supply contract has been previously entered with the client.

José Luis Crespillo
Quality Director
Infrico S.L.

13.1 Warranty certificate

User Name: _____

Address: _____

Phone: _____

Zip Code / City: _____

Distributor: _____

Date of Purchase : _____

Model: _____ Serial No.: _____

Compressor No: _____

Signature Seller

Signature Purchaser

RETURN TO THE MANUFACTURER

User Name: _____

Address: _____

Phone: _____

Zip Code / City: _____

Distributor: _____

Date of Purchase : _____

Model: _____ Serial No.: _____

Compressor No: _____

Signature Seller

Signature Purchaser

FOR THE CUSTOMER



Infrico SL.

Ctra. De Aguilar a A-318 por Moriles km 15,5 - A-3132

14900 Lucena (Córdoba) Spain

T: 00 34 957 59 51 14

F: 00 34 957 59 11 83

info@infricomedcare.com

www.infricomedcare.com

