

Use and maintenance
REFRIGERATORS / FREEZERS



READ THIS USER MANUAL CAREFULLY

Failure to read this manual and any misunderstandings regarding the instructions contained within it can cause irreversible damage to the unit, as well as create a source of danger for users and significantly decrease device performance.

The manufacturer declines all responsibility for any uses other than those listed below.



Any maintenance operations must be carried out by personnel authorized by the manufacturer FIOCCHETTI.



The corresponding warranty will become immediately void in the event of use or maintenance of equipment not in compliance with specifications by the manufacturer FIOCCHETTI.

The material contained in this manual is for informational purposes only. Its contents and the product itself may be subject to change without prior notification. In no event shall the manufacturer FIOCCHETTI be held responsible for any damage due to use of this manual.



Provide all the information required regarding operation of the device being tested in order to request technical support from FIOCCHETTI.



Natural gas but inflammable R290

The refrigerator contains fuel refrigerant, even if permanently sealed according to the standard UNI EN 1127-1.

Do not damage refrigerant circuit tubes.

The environment of installation must have, in compliance with EN378, a volume of 1 m³ every 8 gr of R290 refrigerant contained in the circuit. The quantity of gas included in the circuit is declared on the silver data plate attached inside the device.

Revision	Date	Description
B	09/2015	Update content.
C	06/2016	Updated content.
D	06/2017	Updated content.
E	10/2018	Updated introduction, alarms and failures tables.
F	06/2019	Warning on the refrigerant gas

TABLE OF CONTENTS

1	GENERAL INFORMATION	6
1.1	CERTIFICATION	6
1.2	TESTING AND WARRANTY	6
1.3	PURPOSE, CONTENT AND RECIPIENTS OF THE MANUAL	6
1.4	ARRANGEMENTS PREPARED BY THE CUSTOMER	6
1.5	REQUEST FOR TECHNICAL SUPPORT	7
2	SAFETY	7
2.1	GENERAL SAFETY RULES	7
2.2	SAFETY AND ACCIDENT PREVENTION	7
2.3	CONTRAINDICATIONS	8
2.4	WARNING ON THE REFRIGERANT GAS	8
3	PRODUCT DESCRIPTION	9
3.1	TECHNICAL DESCRIPTION	9
3.2	INTENDED USE	9
3.2.1	<i>laboratory devices</i>	9
3.2.2	<i>medical devices</i>	10
3.3	TRANSPORT AND HANDLING	11
3.4	POSITIONING	11
3.5	CLEANING	12
3.6	WIRING AND ELECTRICAL CONNECTION	12
3.6.1	<i>ELECTRICAL PROTECTIONS</i>	13
3.7	SET-UP OPERATIONS	13
3.8	USE OF THE INTERNAL COMPARTMENT AND MATERIAL STORAGE	13
3.8.1	<i>SHELVES INSTALLATION</i>	14
3.8.2	<i>DRAWERS INSTALLATION</i>	14
3.8.3	<i>PLACING MATERIAL INSIDE THE COMPARTMENT</i>	15
3.9	INDICATION FOR OPTIMAL USE	16
4	ECT-F DISPLAY FUNCTIONING	17
4.1	CONTROL PANEL	17
4.2	ECT-F CONTROL OPERATION	19
4.2.1	<i>SWITCHING ON</i>	19
4.2.2	<i>How to customise the display</i>	20
4.2.3	<i>ECT-F Menu Functions</i>	21
4.2.3.1	Turning off the equipment	21
4.2.3.2	Changing the setpoint	21
4.2.3.3	Manual defrost function	22
4.2.3.4	Recorded alarms log	22
4.2.3.5	Language selection	23
4.2.3.6	Setting the user password	24
4.2.3.7	Service menu	24
4.2.3.8	Setting the date and time	24
4.2.3.9	Doctor View test function	25
4.2.4	<i>Alarm and failure signals</i>	25
4.2.4.1	Fault in progress warning	25
4.2.4.2	Fault ended warning	25
4.3	DMLP DIGITAL MONITOR OPERATION	26
4.3.1	<i>DMLP Digital Monitor Switching On</i>	27
4.3.2	<i>Display configuration</i>	27
4.3.3	<i>DMLP Digital Monitor Menu Functions</i>	28
4.3.3.1	Turning off the DMLP Digital Monitor	28
4.3.3.2	Recorded alarms log	29
4.3.3.3	How to change temperature alarm limits	30
4.3.3.4	Door openings visualization	30
4.3.3.5	Setting the user password	31
4.3.3.6	Setting the date and time	31
4.3.3.7	Printer menu	32
4.3.3.8	Service Menu	36

4.3.3.9	How to remove SD card	37
4.3.3.10	How to modify the language	38
4.3.3.11	How to modify compartment functions (only for double temperature equipment).....	38
4.3.3.12	Special function: TEST	39
4.3.4	<i>Alarm and failure signals</i>	40
4.3.4.1	Fault in progress warning	40
4.3.4.2	Fault ended warning	40
5	ROUTINE AND SPECIAL MAINTENANCE	41
5.1	PROHIBITION OF SAFETY DEVICE REMOVAL	41
5.2	CLEANING THE UNIT INSIDE AND OUTSIDE.....	41
5.3	CLEANING THE CONDENSER	41
5.4	CONDENSATE WATER DRAINING.....	43
6	DEMOLITION	44
7	ANNEXES	44
8	LABELLING	45
8.1	MACHINE DATA PLATE.....	45
8.1.1	OTHER LABELLING	46
9	CONSUMABLE MATERIALS	47
10	TROUBLESHOOTING	48
11	DIAGNOSTIC	49
	ANNEXES	53
	ANNEX 1	53
	ANNEX 2	54

1.1 CERTIFICATION

All Refrigerated cabinets are built in accordance with the relevant European Directives applicable at the time of its placing on the market. The Refrigerated cabinets are certified in accordance with Directives 2006/42/EC, 2014/30/EC, 2014/35/EC and subsequent integrations, built according to the safety requirements for electrical appliances for use in the laboratory (CEI EN 61010-1). In the case of medical devices suitable for the storage of blood or blood products, equipment is certified in accordance with Directive 93/42/EEC and its integration Directive 2007/47/EC.

1.2 TESTING AND WARRANTY

The machine is tested at our factory in accordance with current regulations and it is shipped ready to use. The warranty is valid for 12 months from the date of delivery and establishes the right to repair/replace parts that are defective, not including electrical and electronic parts. Apparent defects and any deviations from orders must be communicated to the manufacturer within 5 days of receipt of the goods under penalty of invalidation of the warranty. Any other defects (not apparent) must be communicated within 5 days of discovery, and in any case within the maximum 6 months warranty period. The customer will only be entitled to the repair or replacement of goods, with the absolute exclusion of any direct or indirect damages of any kind. In any case, the right to repair or replacement of materials must be exercised within the maximum time limit provided by the warranty, with the time limits having been contractually reduced with respect to those established by law. Repair or replacement of defective materials will occur at the manufacturer's factory, where materials must be delivered with freight prepaid. The manufacturer will then return them carriage forward.

1.3 PURPOSE, CONTENT AND RECIPIENTS OF THE MANUAL

This manual has been drafted for the purpose of providing all the instructions necessary for correct use of the machine and for maintaining it in perfect condition, in particular with regard to the user's safety. The following professional figures shall be defined in order to identify tasks and responsibilities:

Installer: qualified technician who performs machine placement and commissioning in accordance with the instructions in this manual.

User: person who, after carefully reading this manual, uses the machine for his own permitted uses. It is mandatory for the user to read the manual carefully and make reference to it.

Routine maintenance worker: qualified technician able to carry out routine maintenance on the machine, following the instructions in this manual.

Special maintenance worker: qualified technician authorised by the manufacturer, able to carry out special maintenance on the machine.

The manufacturer declines any responsibility for improper or unreasonable use of the machine and for all those operations carried out on the same ignoring the instructions in this manual.

The manual must be kept in an accessible location known to all operators (installers, users, routine and special maintenance workers).

No part of this manual may be reproduced and/or disclosed by any means and in any form whatsoever.

1.4 ARRANGEMENTS PREPARED BY THE CUSTOMER

The following arrangements are set by the customer:

- The machine electrical connection, with care of SUPERARTIC models
- Installation site arrangement
- Routine maintenance
- Refrigerator cleaning and the products used for it

1.5 REQUEST FOR TECHNICAL SUPPORT

Provide all the information required regarding operation of the device being tested in order to request technical support from FIOCCHETTI.

For this purpose, send the table in Annex 1 (pag. 53) "USER DATA FOR TECHNICAL SUPPORT REQUEST" filled in.

Technical support department e-mail	assistenza@fiocchetti.it
Sales department e-mail	commerciale@fiocchetti.it
Support request	http://www.fiocchetti.it/it/tecnico-frigo.asp
User manual request	http://www.fiocchetti.it/it/manuali-frigoriferi-congelatori-emoteche.asp
Tel.	+39 0522 976232
Fax	+39 0522 976028

Our Technical Support Department can provide all the information you need for correct unit operation and can put you in touch with your nearest authorised service centre. Our Sales Department staff provides information on prices and availability of requested components.

2

SAFETY

2.1 GENERAL SAFETY RULES

Read the manual carefully and follow instructions contained herein. Do not use the equipment for purposes other than those for which it was designed.

The user assumes full responsibility in case of operations carried out without observing the instructions in the manual. Below is a list of the main safety rules:

- Do not touch the equipment with moist or wet hands or feet.
- Do not insert screwdrivers or other objects into the guards or moving parts.
- Do not pull the power cord to disconnect the appliance from the electrical mains.
- Do not allow the machine to be used by unauthorised users.
- Before performing any cleaning or maintenance, disconnect the machine from the electrical mains by switching it off and disconnecting the plug.
- In case of failure and/or malfunction, switch off the machine and do not attempt to repair or service it on your own. It is absolutely necessary to contact qualified personnel.

2.2 SAFETY AND ACCIDENT PREVENTION

This machine has been designed with suitable measures to assure safety and the health of the user. The following is a list of protections adopted against mechanical risks:

- **Stability:** the machine has been designed and built in order to guarantee its stability in all foreseen operating conditions, even with shelves/drawers extracted, without any risk of tipping, falling, or sudden movement.
- **Surfaces, edges, corners:** within the limits permitted by their functions, accessible parts of the machine have no sharp corners, sharp edges or rough surfaces that could cause injury.
- **Moving parts:** all components with the possibility of movement have been designed, built and configured to avoid risk. Some parts are also protected by fixed guards to prevent contact or injury.

The following is a list of measures adopted to protect against other risks:

- **Electrical power:** the machine has been designed, built and fitted with the aim of preventing risks of electric shock, in compliance with established safety regulations.
- **Noise:** the machine has been designed and built to minimise risks related to the emission of acoustic noise (always lower than 70 dB).



The following is strictly forbidden:

- Tampering with or removing the evaporator cover enclosure that protects the user from a risk of cutting on the evaporator fins
- Removal of the data plates fixed in the inside edge of the motor compartment that contain technical specifications and earth connection warnings
- Removal of the data plate fixed on the evaporator unit guard and near the electrical wiring inside the motor compartment, which warns the user to disconnect power before working on the unit.



The manufacturer declines any responsibility for safety of the machine if the above recommendations are not observed.

2.3 CONTRAINDICATIONS

The refrigerated cabinet must not be used:

- exposed to weathering
- With adapters or extension cords
- In explosive atmospheres or where there is a risk of fire
- Near to heat sources (radiators, etc.)

2.4 WARNING ON THE REFRIGERANT GAS

If in the device a flammable gas is used like R290 refrigerant, the following label appears on the compressor.



In this case, some special precautions should be taken:

- position the appliance in an environment of suitable dimensions in compliance with EN 378: the environment must have a volume of 1m³ every 8gr of R290 refrigerant. The quantity of gas contained in the circuit is declared on the silver data plate attached inside the cabinet.
- do not use the equipment if damaged.
- to avoid damages to the refrigerant circuit, do not use mechanical devices to accelerate defrost process.
- make sure that air grids are always free to guarantee a certain ventilation to the device.
- if there is refrigerant leakage, avoid using open flames, remove from the device flammable products and ventilate immediately the environment.
- do not store potential explosive substances (for example spray cans containing flammable gases) inside the device.

Do not use electrical appliances inside the refrigerated cabinet.

If any malfunction, disconnect the equipment from the mains.

Extraordinary maintenance should be performed only by qualified personnel.

3.1 TECHNICAL DESCRIPTION

The refrigerated cabinet covered by this manual produces cold by means of low-pressure vaporisation of a liquid refrigerant, such as HCFC, HFC, inside a heat exchanger (evaporator). The vapour thus obtained is brought back to the liquid state by means of a higher pressure mechanical compression (via a compressor) followed by cooling in another heat exchanger (condenser). The correct, uniform distribution of air inside the cabinet is guaranteed by one or more fan motors, depending on the model.

The machine is composed of a modular monocoque coated with different materials and insulated with polyurethane foam at a density of 43 kg/m³.

The instrumentation is grouped on the front panel. On some models, the motor compartment, where the condenser unit and electrical wiring can be housed, closes automatically.

Inside, the machine is equipped with brackets suitable for supporting wire shelves, extractible drawers and steel baskets. The doors on all machines are equipped with a closing device with automatic return and door lock and easily replaceable magnetic seals for perfect tightness. Measures were taken during design and construction to obtain a machine that meets specific safety requirements, such as internal rounded corners, condensate liquid drainage, no rough surfaces, fixed guards on moving or potentially dangerous parts, and so on.

The maximum capacity of shelves and drawers load on all Fiocchetti models is 30 kg with weight uniformly distributed.



All models are for indoor use and cannot be installed outdoors. Warranty will immediately expire, if equipment is installed improperly.

3.2 INTENDED USE

All the listed models are suitable for storage. For this reason, we suggest only storing products that have already been refrigerated or frozen (depending on the model).

We declare that any use outside of those allowed by the machine is considered as “improper use” and therefore the manufacturer declines all responsibility.

3.2.1 LABORATORY DEVICES

Laboratory devices are suitable for:

- Storage of correctly packaged drugs, vaccines, and reagents that are not liquids or body tissues intended for administration or introduction into the body
- Storage of other substances or materials for general use in a non-flammable or non-explosive hospital, laboratory or pharmaceutical environment
- They are not to be used for the storage of blood, fluids or body tissues.

This category includes series models:

MEDIKA	+2°C +15°C
MEDIKA 2T	+2°C +15°C
LABOR	+2°C +15°C
LABOR 2T	+2°C +15°C / -15°C -24°C
VISION	-10°C -20°C
VISION 2T	+2°C +15°C / -10°C -20°C
FREEZER	-10°C -25°C
SUPERARTIC	-20°C -40°C
SUPERARTIC 2T	+2°C +10°C / -20°C -35°C
TER	+15°C +30°C
SPARK PROOF	+2°C +15°C

3.2.2 MEDICAL DEVICES

According to Directive 2007/47/CEE and Directive 93/42/CEE, class IIa medical devices are intended to:

- Storage of blood, fluids or body tissues
- Storage of correctly packaged drugs, vaccines, and reagents of any kind
- Storage of other substances or materials for general use in a non-flammable or non-explosive hospital, laboratory or pharmaceutical environment.

This category includes models:

EMOTECA	+4°C
EMOTECA TWIN	+4°C
PLASMA VISION	-15°C -20°C
PLASMA VISION 2T	+2°C +15°C / -15°C -20°C
PLASMA FREEZER	-10°C -25°C
PLASMA-LABOR 2T	+2°C +15°C / -15°C -20°C
PLASMA SUPERARTIC	-20°C -40°C
PLASMA SUPERARTIC 2T	+2°C +10°C / -20°C -35°C

3.3 TRANSPORT AND HANDLING

The machine must be transported and handled solely in a vertical position and following the instructions printed on the packaging. This precaution is necessary to avoid contamination of the compressor with oil which may cause the rupture of valves, of the cooling coils and problems with electric motor starting.

The accessories supplied with the machine (slides, wire shelves, drawers, baskets, etc.) are shipped inside the unit. The machine is fixed on a wooden pallet by means of screws, wrapped with polyethylene and packaged in cardboard, a wooden crate or wooden case.

The machine must be handled using a forklift or pallet truck with suitable forks (fork length at least equal to 2/3 length of the unit).



If the machine needs to be set down in order to bring it into the installation location, it is absolutely necessary to wait at least 6 hours before switching it on.

The manufacturer declines any responsibility for problems due to transport carried out in any condition different from those specified above.

3.4 POSITIONING

Incorrect positioning can cause damage to the machine and create dangerous conditions for users; therefore, the installer must comply with the following general rules:

- Position the machine keeping a minimum distance of 10 cm from all walls. If the machine is embedded in any type of furniture, a correct air flow of the condensing unit (compressor/fan motors) must be always ensured. The warranty will immediately expire, if this is not guaranteed. (Figure 1 – equipment position)

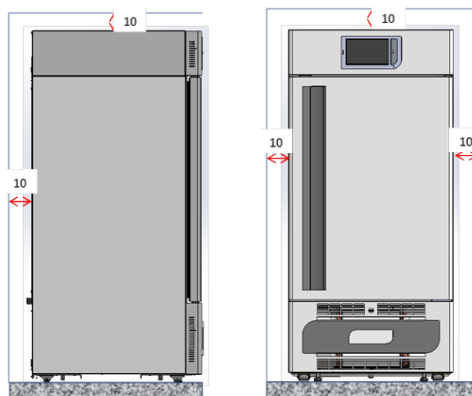

Figure 1 – equipment position

- Set the machine in a sufficiently ventilated environment.
- Place the machine far from heat sources and far from sources of electromagnetic interferences (such as motors, generators, infrared beams, telephones) which can have negative effects on equipment functioning.
- Avoid exposure to direct sunlight and air conditioning flows.
- Remove the supplied accessories and the wooden pallet base.
- Position the machine with the aid of a spirit level. If necessary, adjust the levelling feet on the metal base (on models fitted with adjustable feet) (Figure 2 – adjusting feet).

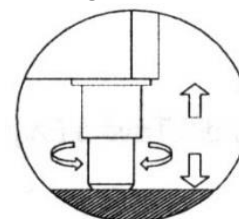

Figure 2 – adjusting feet

3.5 CLEANING

Equipment is shipped already cleaned. However, it is advised to carry out a further washing following the instructions below:

- Remove the protective PVC film from the external surfaces of the machine.
- Clean the inside of the chamber with a cloth dampened with alcohol in order to eliminate the protective oil.



The glass door must be cleaned using a cloth dampened with water.



Do not therefore use chemicals.



Figure 3 - glass cleaning label

3.6 WIRING AND ELECTRICAL CONNECTION

The electrical system and connection must be set up by qualified personnel. Please follow the instructions below for safety reasons:

- Make sure that the system is suitably sized for the absorbed power of the machine.
- It is essential to properly connect the machine to an effective grounding system set in accordance with current legislation.
- In the event of incompatibility between the outlet and machine plug, replace the outlet with a suitable type, provided that the part is approved according to the laws in force.
- If electrical cable is damaged, it must be replaced by qualified personnel to prevent any risk.
- If the freezer is supplied without a plug, connect it directly under the switch board.
- Do not interpose adapters and/or reducers.



Special attention should be paid to SUPERARTIC model electrical connection as absorption is high. Prepare cables with a cross section of at least 2.5 mm² and with a limited length.

3.6.1 ELECTRICAL PROTECTIONS

Fiocchetti devices are equipped with 2 safety fuses (phase and neutral) with integral protection against electric shocks, short circuits and over-currents, and according to the standards for laboratory devices.

The fuses can be accessed from the front: open the refrigerator door and the fuses will be found behind the front control unit panel. The replacement must be done by qualified personnel.

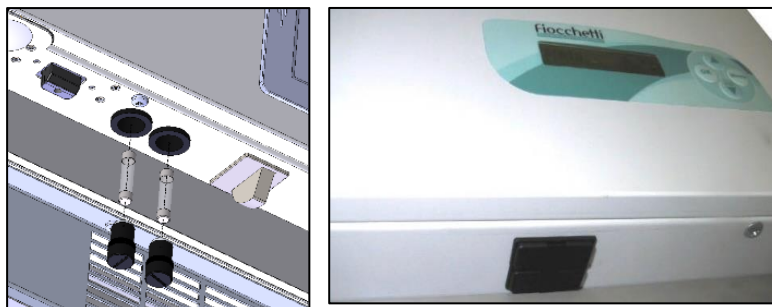

Figure 4 – Fuse housing

3.7 SET-UP OPERATIONS

Before turning on the appliance, it is necessary to check that it has not been damaged during transport, handling and installation.

- Check the condition of the packaging (it must not show dents and/or breakages)
- Check the condition of the external frame (it must not show dents and/or breakages)
- Check the condition of the power cord (it should not have scratches or cuts).
- Check that the feet and/or wheels are stable.
- Check that door opens correctly and closes hermetically
- Check door gaskets (they should not have scratches or cuts)
- Check that display do not show cracks.

3.8 USE OF THE INTERNAL COMPARTMENT AND MATERIAL STORAGE

The stainless-steel rack system allows for the installation of fully extractable drawers on telescopic guides with "bayonet connection" and with the possibility of having a mixed arrangement of completely interchangeable drawers/shelves. SUPERARTIC and PLASMA SUPERARTIC models use drawers mounted on extractable slides, not telescopic.

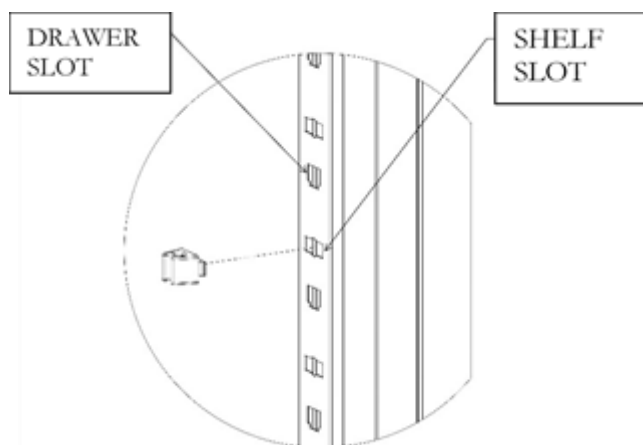

Figure 5 – Slots for internal fittings

3.8.1 SHELVES INSTALLATION

Position the shelf supports on the rack at the desired position, inserting them into the special slots and turning them of 90° to block them. At this point, insert shelves (Figure 6 – shelves installation)

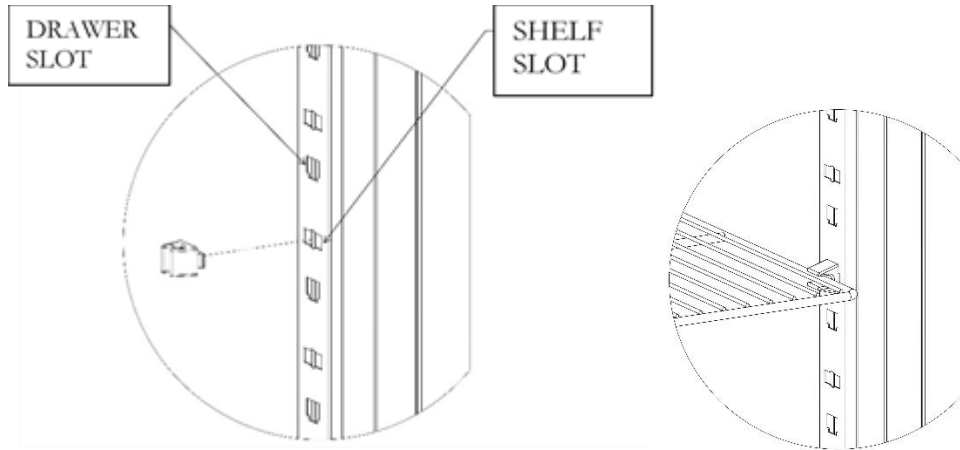

Figure 6 – shelves installation

3.8.2 DRAWERS INSTALLATION

Insert the guides into the special slots of racks (Figure 7) and pull out the telescopic guides by gently pressing on the white lever (Figure 8), install them on the drawer (Figure 9) and fill the drawer on the guides installed on racks (Figure 10).

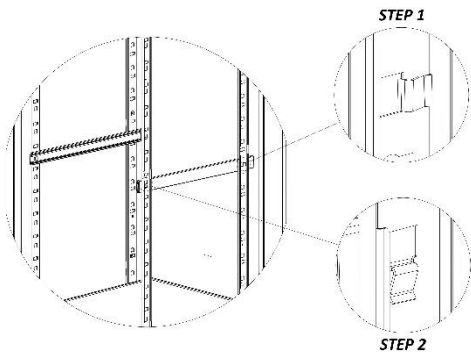

Figure 10 – guides installation

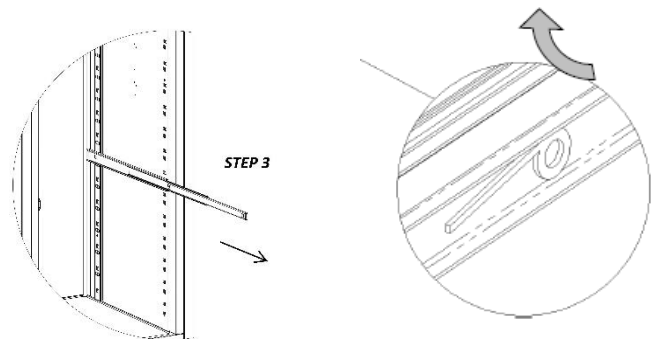

Figure 7 – pulling guides out

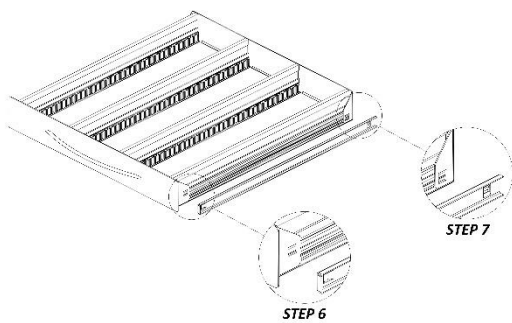

Figure 8 – guides installation on drawer

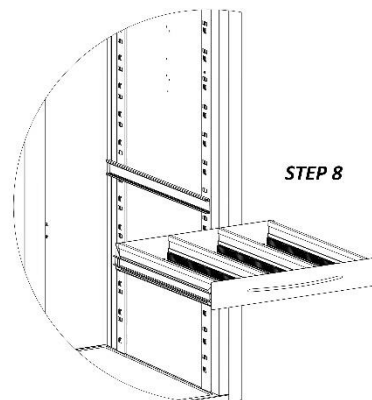

Figure 9 – installation of drawer on rack

3.8.3 PLACING MATERIAL INSIDE THE COMPARTMENT

Care must be taken when loading material, to avoid malfunctions and allow air flow to ensure temperature uniformity inside the refrigerated compartment.

Observe the following instructions:

- ✓ Do not place material over the label indicating the maximum permitted loading level, if present.



Figure 11 - Max. level label

- ✓ Store material leaving a distance of at least 6 cm from sides and at least 18 cm from the top of the compartment (Figure 11-12)

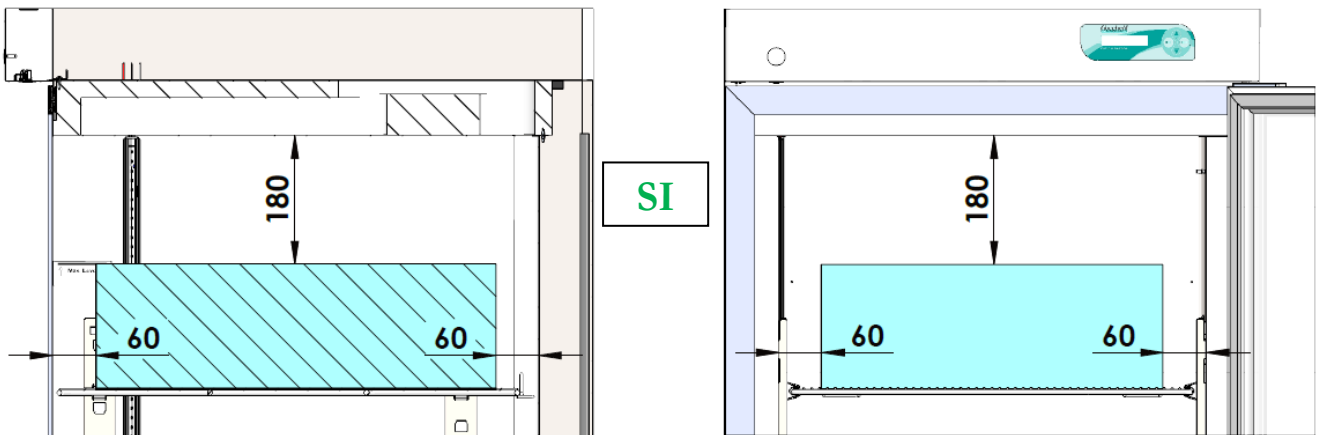

Figure 12 – Correct material storage

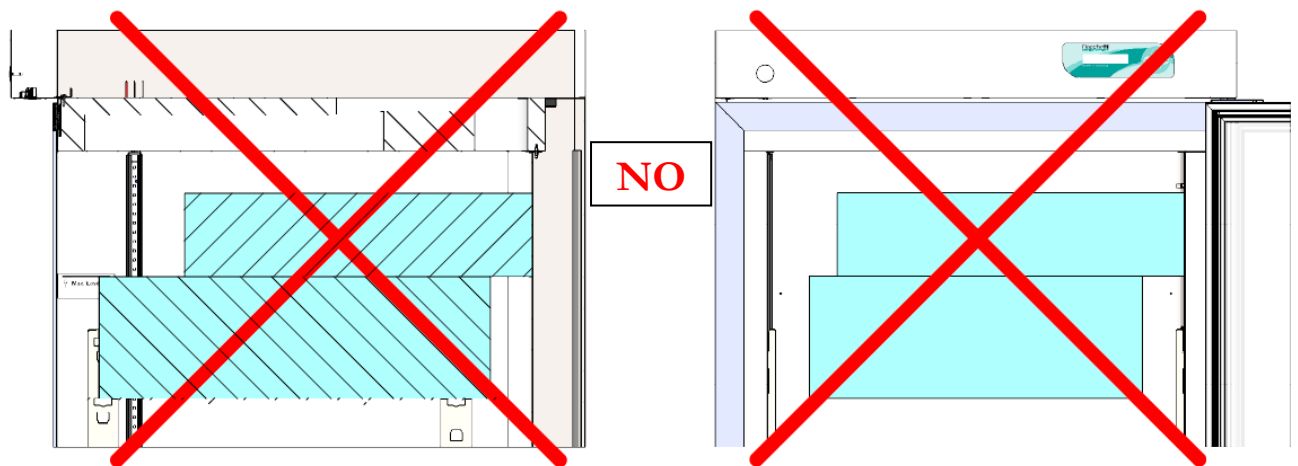

Figure 13 – INCORRECT material storage

- ✓ Do not position material in contact with or near the temperature probes (Figure 14).

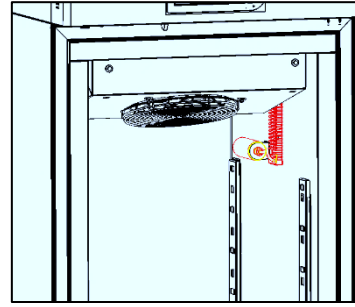
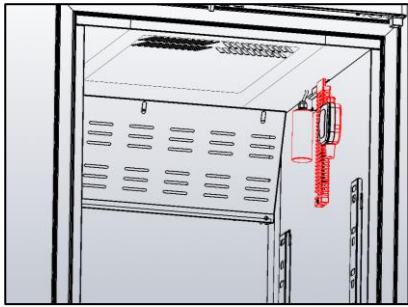

Figure 14 – probes position

- ✓ Do not block air vents (Figure 15) and pressure equalising valve in SUPERARTIC models (Figure 16).

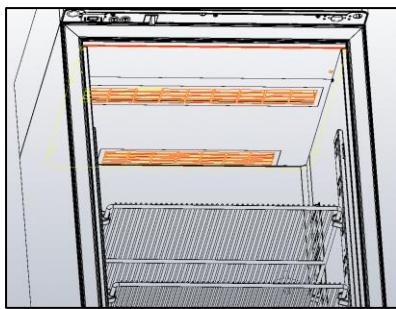

Figure 15 – air vents at the top of the compartment

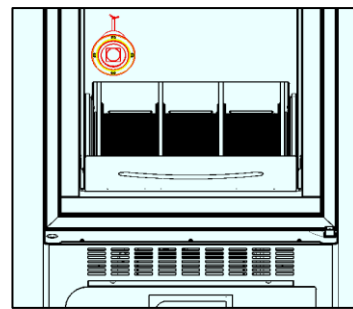

Figure 16 – position of the SUPERARTIC model pressure equalising valve

3.9 INDICATION FOR OPTIMAL USE

The following instructions are provided to the user to follow in order to get the best equipment performances:

- The power supply must comply with the information provided on the technical data plate (+/- 10%).
- The units have been designed and built to work in environment with temperatures falling within the climatic class temperatures indicated on the technical data plate (see Par. 9.1) and at a relative humidity of 60%.
- Do not block the motor compartment air vents.
- Load stored material gradually at ambient temperature to grant proper refrigeration.
- Store material on shelves (or drawers). Do not place products directly on the bottom, or against the wall, doors or fixed guards of the unit (see Par. 4.6.3)
- Make sure doors are closed properly.
- Limit door opening frequency and duration. Each time the door is opened, the internal temperature will alter and there will be possible ice formation on the evaporator
- Keep the defrost water drain outlet clear.
- Follow a regular maintenance schedule (see Par. 6)

4 ECT-F DISPLAY FUNCTIONING

The device is equipped with a latest generation Electronic Controller, with a back-lit LCD alphanumeric display, to display temperature and working operations with an accuracy of 0.1°C. The controller gives maximum safety in case of alarms and fault conditions, signalling critical conditions and registering every event in order to help the service engineer to speed up the analysis and thus the fixing of any problems.

4.1 CONTROL PANEL

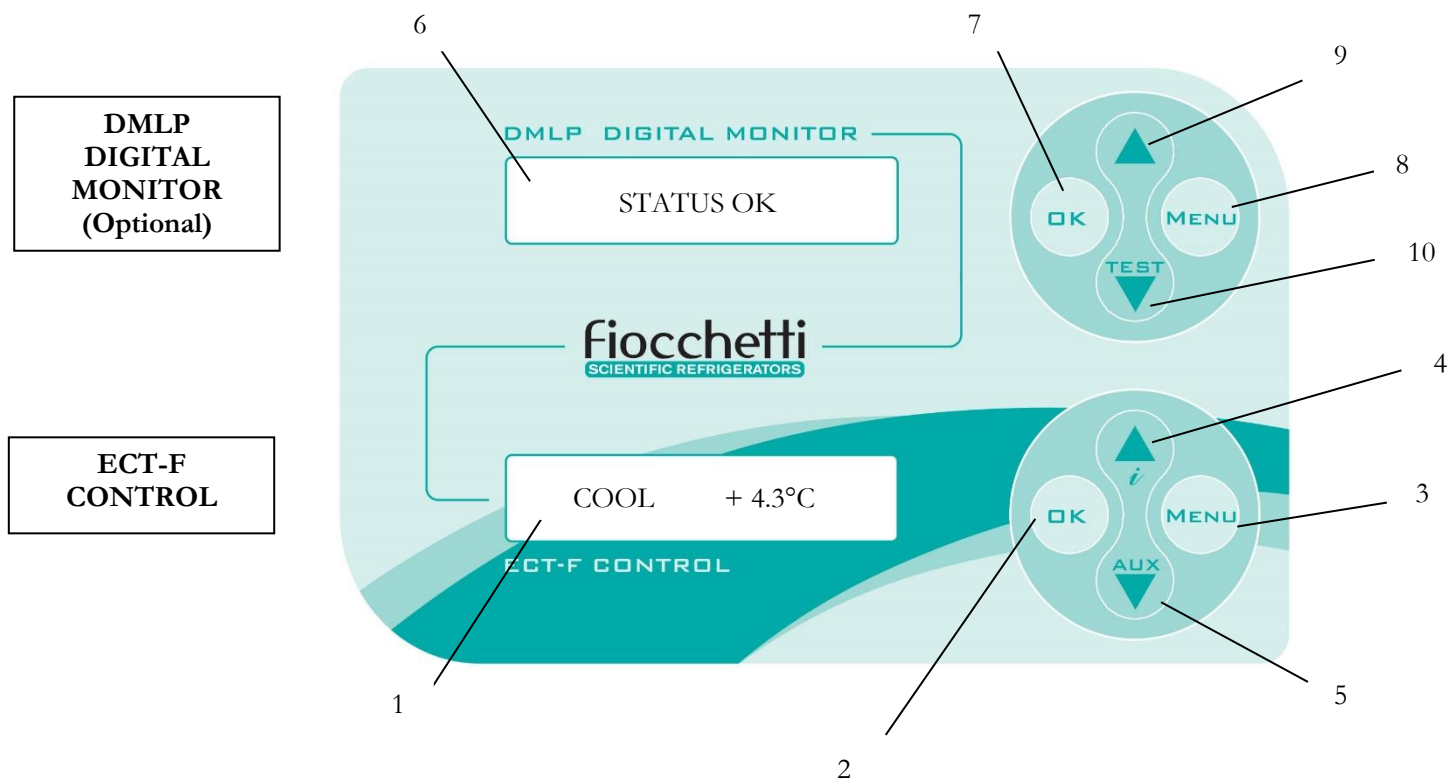

Figure 17 – User panel interface

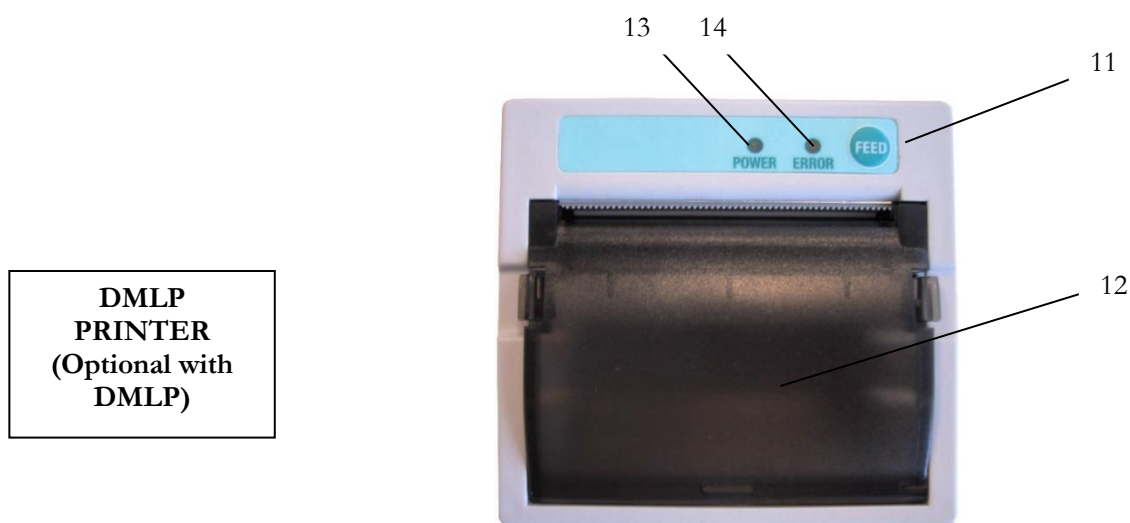











Figure 18 – DMLP Printer



Table 1 – Keypad functions

ECT-F CONTROL	1	/	Alphanumeric LCD Display, back-lit.
	2		To confirm.
	3		To Enter and Esc from the menu.
	4		To increase values, scroll menu and for INFO DOCTOR VIEW special function.
	5		To decrease values, scroll menu. Switching on/switching off glass door LIGHT (timed for Medical Devices)
DMLP DIGITAL MONITOR	6	/	Alphanumeric LCD Display, back-lit.
	7		To confirm.
	8		To Enter and Esc from the menu.
	9		To increase values, scroll menu.
	10		To decrease values, scroll menu and test.
DMLP PRINTER	11		Feed paper.
	12	/	Paper space.
	13	Power	Led (green light) when printer is fed (during print out).
	14	Error	Led (red colour) will blink feebly when data is transmitted or with a brighter colour when no paper is available or paper is stuck.

4.2 ECT-F CONTROL OPERATION

4.2.1 SWITCHING ON

To switch on the equipment for the first time follow these below instructions:

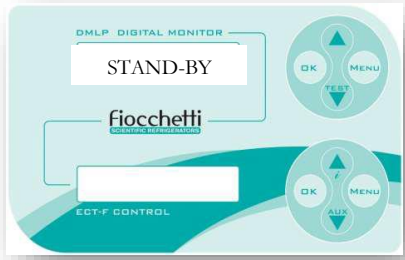
1.	Connect the plug to the electric socket.	 <p>© Can Stock Photo</p>
2.	The display will show “STAND-BY”, which indicates the presence of mains power.	
3.	To switch on the equipment, press any button for two seconds.	
4.	When ECT-F is switched on, the display can be customised in four different modes using OK button (see par. 5.2.2)	<div style="border: 1px solid black; padding: 5px; margin-bottom: 5px;"> PAUSE +4,5°C mode 1 </div> <div style="border: 1px solid black; padding: 5px; margin-bottom: 5px;"> S + 4.0°C +4,5°C mode 2 </div> <div style="border: 1px solid black; padding: 5px; margin-bottom: 5px;"> 12:44 01/11/2017 mode 3 </div> <div style="border: 1px dashed black; padding: 5px; margin-bottom: 5px;"> 56% Rh +4,5°C mode 4 </div>
5.	<p>Once connected the equipment to the mains, if DMLP Digital Monitor is installed, the STAND-BY string will appear.</p> <p>Switch on the DMLP Digital Monitor pressing any button for two seconds.</p>	

4.2.2 HOW TO CUSTOMISE THE DISPLAY

Pressing the button  , the LCD display can be customized in four different modes.

Figure 19 – display customization

Mode 1	Mode 2	Mode 3	Humidity mode
PAUSE +4,5°C	S + 4.0°C +4,5°C	12:44 01/11/2017	56% Rh +4,5°C
Working status and temperature	Setpoint and temperature	Date and hour <u>(not present with DMLP Digital Montor)</u>	Relative humidity % <u>(only if humidity probe is installed)</u>



When Mode 1 is selected, the following strings can be visualized:

Table 2

STRING	OPERATION IN PROGRESS
PAUSE	The compressor is OFF, waiting for next cooling cycle
COOL	The compressor is ON to reach setpoint
WAITING DEFROST	After request of manual defrosting, the controller waits for the necessary conditions to proceed automatically with defrosting
ACCESS DENIED	Attempt to access a disabled menu or after a manual defrost request if the conditions are not suitable for such action
DEFROST	The refrigerator defrosts, warming up the evaporator
DRIPPING	Last phase of defrosting to allow evaporator dripping
RECOVERY	The compressor is ON after defrosting to re-acquire the temperature
DOOR	Door open (close immediately)
HEATING	Heating action active

4.2.3 ECT-F MENU FUNCTIONS

Use the button  to access the list of available functions.

Scroll the menu using the buttons  and .







Attention: to exit from different menus, press  to go back to the set display.

Table 3- User menu functions

Function	Description of the function
TURN OFF m1	To switch off the controller and stops temperature control
CHANGE SETm2	To customise temperature setpoint
CHANGE Rh% m3	To set humidity (<u>only if humidity probe is installed</u>)
DEFROST m4	To defrost manually
DEEP FREEZE m5	To switch on the compressor on a time-base (<u>only for prepared models</u>)
LIST ALARMS m6	To visualize recorded alarms
LANGUAGE m7	To change strings' language
PASSWORD m8	To set user password in order to access the menu
MENU SERVICE m9	To enter service menu functions
CLOCK SET m10	To set date and time (not present when DMLP is installed)

4.2.3.1 Turning off the equipment

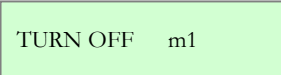
Press the button  and the string  will appear. Press the button  to confirm.

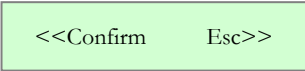

At this point, the controller requests further confirmation of the command:



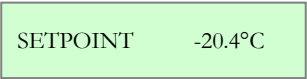

To confirm, press the button  again or  to cancel the operation (Esc) and go back to main menu.

4.2.3.2 Changing the setpoint

Press the button  and by using the buttons  or  stops at the string 

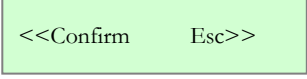
Confirm with the button . The display will start flashing the actual Temperature Setpoint . This can be modified using buttons  or , with increments of 0.1°C.

Confirm by pressing the button . The display will show a message asking to confirm or to exit from the Menu with the message .

Confirm again with the button . The display will show the message  and the controller will start adjustment with the new temperature setpoint value.



Instead, press the button  to cancel the operation and go back to main menu.

4.2.3.3 Manual defrost function

Fiocchi cabinets are equipped with automatic, intelligent defrosting, or rather defrosting which only occurs if deemed necessary by the controller. The number of daily defrosts is therefore significantly reduced, resulting in considerable energy savings. However, it may sometimes be necessary to perform manual defrosting. This function is enabled by following the procedure below.

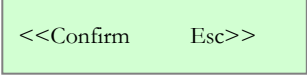
Press the button  and by using the buttons  or  stops at the string .

Confirm by pressing the button . The display will show a message asking to confirm or to exit from the Menu with the message .

Confirm again with . The controller acquires the defrosting order and the display shows the message .

If manual defrost cannot be enabled until the conditions required for its implementation are detected, the display will show the message .

If defrost is delayed by the controller due to certain pre-set managing parameters, the display will show the message .

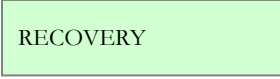
At the end of defrost, the phases  and  will proceed until the next setpoint is reached.

4.2.3.4 Recorded alarms log

The controller signals four types of temperature alarm and records the last 16 events in the corresponding .

Alarms are recorded as follow:



Alarm description	Alarm code
HIGH TEMP	H
HIGH TEMP DURING POWER FAILURE	B
LOW TEMP	L

Table 4 – Types of temperature alarm

Press the button , positioning yourself using the buttons  or  on the string 

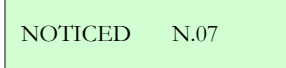
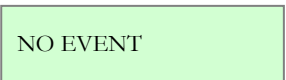
Confirm with the button . The display will show the total number of alarms present in the memory up to that

moment → . If there are no alarms in the memory, this will be indicated with the string .

If there are alarms to be seen, press the button  to view the details of the last recorded event. Use the button  to scroll back to the first in memory

The information available is described in the following frame.

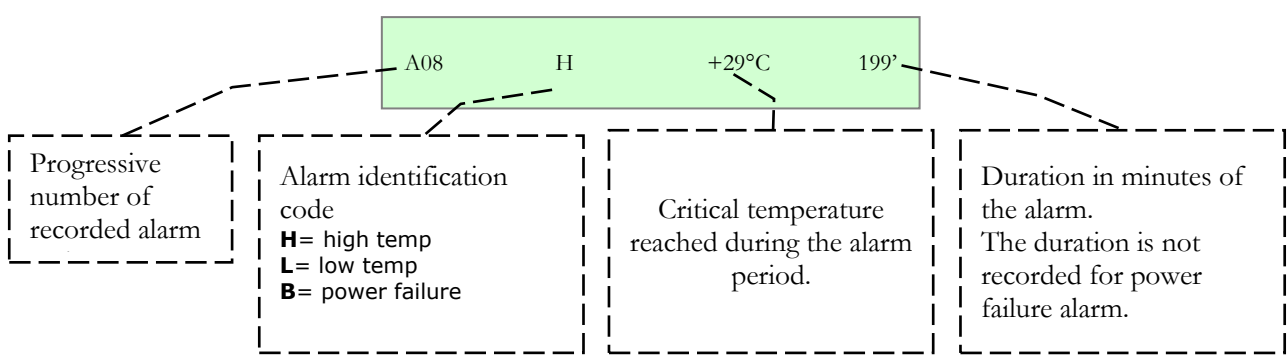

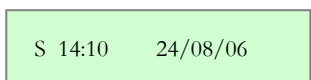
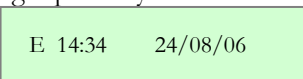



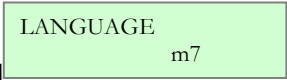





Figure 20 – Information on recorded alarm

Pressing repeatedly the button  the start date/time (S)  and the end date/time of the alarm  are displayed.

 When DMLP Digital Monitor is installed, all alarms will be detected by it and not by ECT-F controller. Failure alarms are detected in anyway by ECT-F controller.

4.2.3.5 Language selection

Press the button  and use the buttons  or  to move to the menu corresponding to the language selected .

Use the arrows  or  and confirm with  to select the desired language from:





- LINGUA ITALIANA
- ENGLISH LANGUAGE
- LANGUE FRANCAISE
- IDIOMA ESPANOL
- DEUTSCHE SPRACHE

4.2.3.6 Setting the user password

This menu lets you set a new user password which will be asked when switching on and off the controller and when setting the setpoint.

Press the button  and use the buttons  or  to move to the menu corresponding to the password

PASSWORD m8

Press the button  and the password currently in use will be requested, which then you will be able to edit (if any password has been entered, nothing is requested). Select the password in use using the buttons  or  and confirm with .







Setting the password = 00 will disable password protection.
If the password is lost, contact the manufacturer or technical support to retrieve it.



4.2.3.7 Service menu

Only Technical Support can enter into this menu.

4.2.3.8 Setting the date and time

Press the button  and by using the buttons  or  stops at the menu

CLOCK SET m10

Confirm with . The display will show the date and time, with the time flashing. Adjust using buttons  or



and confirm with , until you reach the last two digits which relate to the year.



If the time is lost (low battery), the display will show the flashing frame **h00 m00:00**.

4.2.3.9 Doctor View test function



Press for few seconds the button  to activate DOCTOR-VIEW function. This TEST checks buzzer for 5 sec. (TEST BUZZER); then, it shows by sequence the SETPOINT, EVAPORATOR temperature, CONDENSER temperature, high and low set limits, alarm time delay, the maximum duration allowed when DOOR is open and battery tension (if battery is installed).

If any button is pressed during the test, this will stop automatically.

4.2.4 ALARM AND FAILURE SIGNALS

4.2.4.1 Fault in progress warning

In the event of any system abnormality, an audible and visual warning is immediately signalled to the user by means of the flashing display and the sound of the buzzer.

ALARM DETECTED

In the event of a temperature alarm, the display will also show the string  alternating with the pre-set display mode (described in the previous chapter Par. 5.2.2.).

Press any button at any time to silence the buzzer.

The faults that the controller can detect are as follows.

MESSAGE	TYPE OF FAULT IN PROGRESS
HIGH TEMP	High temperature inside the chamber.
LOW TEMP	Low temperature inside the chamber.
POWER FAIL <HT>	High temperature after power failure or mains disconnection.
DOOR	Door open alarm.
PROBE S1	Faulty chamber probe (call Service)
PROBE S2	Faulty evaporator probe (call Service)
PROBE S3	Faulty condenser probe/aux (call Service)
LOW EVAPORAT	Evaporator high temperature (call Service)
HIGH CONDENS	Condenser high temperature (call Service)
h00:m00	Clock-data loss (call Service)
DEFROST TIME	Inadequate defrosting time (call Service)
I2C	Events or strings memory failure (call Service)
CLEAN CONDEN	Inadequate thermal exchange: clean or free the condenser.
COMPRES. WORK	Maximum allowed continuous working % during the last 24 hours.
NOTICED ALARM	Temperature alarm occurred, in the presence or absence of mains (reset the alarm – see par. 5.2.4.2)

Table 5 – Faults detected by the controller



The refrigerator will continue functioning correctly until the arrival of a service engineer, despite the above alarms.

4.2.4.2 Fault ended warning

When the alarm condition is finished, the display will alternately visualise the message ALARM NOTICED with the standard pre-set display until the user accesses the Alarm list menu.



Follow the procedure in [par. 5.2.3.4](#) to reset the alarm.
To silence the alarm, press any button.

4.3 DMLP DIGITAL MONITOR OPERATION

The equipment can be supplied with DMLP Digital Monitor, completely independent from the ECT-F controller, to record the temperatures, temperature alarms and power failures (thanks to a backup battery supplied as standard, automatically re-charged).

When the DMLP Digital Monitor is switched on (see par. 5.2.1 – point 5), it monitors and records every minute of operation. Data is stored in two internal memories. The first memory is represented by DMLP Printer (if installed): it grants a quick access to the last recorded 45 days. The second memory is an SD Secure Digital card, a black box that grants at least five year of data storage.

The information stored on the SD Card is:

- Day of the week, date and hour
- Temperature chamber A and B (probe chamber A and probe chamber B)
- Door status chamber A and B (probe chamber A and probe chamber B)
- Door openings time chamber A and B (probe chamber A and probe chamber B)
- Relay status (dry contact)
- Battery voltage, mains presence/absence
- High and low temperature limits and alarm delay time
- Alarms and failures codes
- Modified parameter code

DMLP Digital Monitor includes an internal lock to register all the events and no. 2 dry contacts + RS485 IN/OUT for bi-directional remote control/monitoring (Web Light Server and/or GSM Communicator).

4.3.1 DMLP DIGITAL MONITOR SWITCHING ON

To switch on the DMLP Digital monitor for the first time follow these instructions:

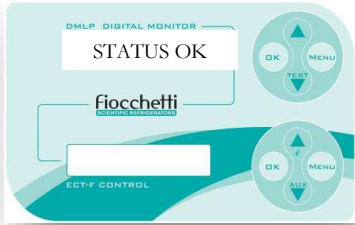
1.	Connect the plug to the electric socket.	 <p>© Can Stock Photo</p>
2.	<p>The display will show “STAND-BY”, which indicates the presence of mains power.</p> <p>To switch DMLP Digital Monitor on, press any buttons for two seconds.</p>	
3.	<p>When DMLP Digital Monitor is switched on, the display can be customised in two different modes using OK button (see par. 5.3.2.).</p>	<div style="border: 1px solid black; padding: 5px; margin-bottom: 10px; text-align: center;"> STATUS OK mode 1 </div> <div style="border: 1px solid black; padding: 5px; text-align: center;"> 12:44 01/11/2017 mode 2 </div>

4.3.2 DISPLAY CONFIGURATION

The display can be configured in two different modes by pressing  button.

Figure 21 – DMLP display visualization modes

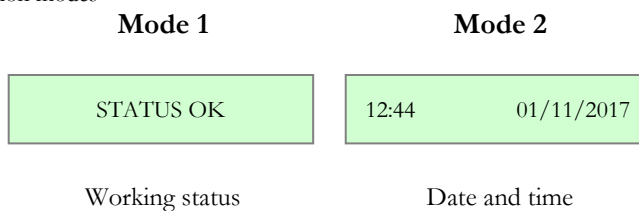

DMLP Digital Monitor must be always in STATUS OK to grant the recording on SD CARD.

4.3.3 DMLP DIGITAL MONITOR MENU FUNCTIONS







Use the button  to access the list of available functions. Scroll the Menu using  and .

Table 6 – DMLP menu functions

Function	Description of the function
TURN OFF m1	To switch off the DMLP Digital Monitor.
ALARMS LIST m2	To display the recorded alarms.
LIMITS m3	To set high and low temperature limits.
DOOR OPENINGS m4	To visualize the number of door openings.
PASSWORD m5	To set a user password to access to the menu.
CLOCK SET m6	To set controller date and time.
PRINTER MENU m7	To access to printer menu.
SERVICE MENU m8	To access to the service menu (only for Technical support).
SD EXTRACTION m9	To remove SD card properly.
LANGUAGE m10	To change the strings language.
MODE m11	To access to the chamber exclusion (only for double temperature equipment)

4.3.3.1 Turning off the DMLP Digital Monitor

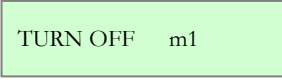
Press the button  and the string  will appear. Press the button  to confirm.

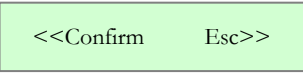
At this point, the controller requests further confirmation of the command: 

To confirm, press the button  again or  to cancel the operation (Esc) and go back to main menu.

4.3.3.2 Recorded alarms log

The controller signals three types of alarms and it records the last 12 events in the corresponding

ALARMS LIST m2

These are catalogued in

Alarm description	Alarm code
HIGH TEMP	H
MAINS FAILURE	B
LOW TEMP	L

Table 7 – Types of temperature alarms

Press the button , then use  or  till the following string



ALARMS LIST m2

Confirm with the button , the display will show the total number of alarms present in the memory up to that

moment
DETECTED N.07

NO EVENT

If there are no alarms in the memory, this will be indicated with the string

If there are alarms to be seen, press the button  to view the details of the last recorded event. Use the button  to scroll back to the first alarm recorded.

The information available is described by the following frame:

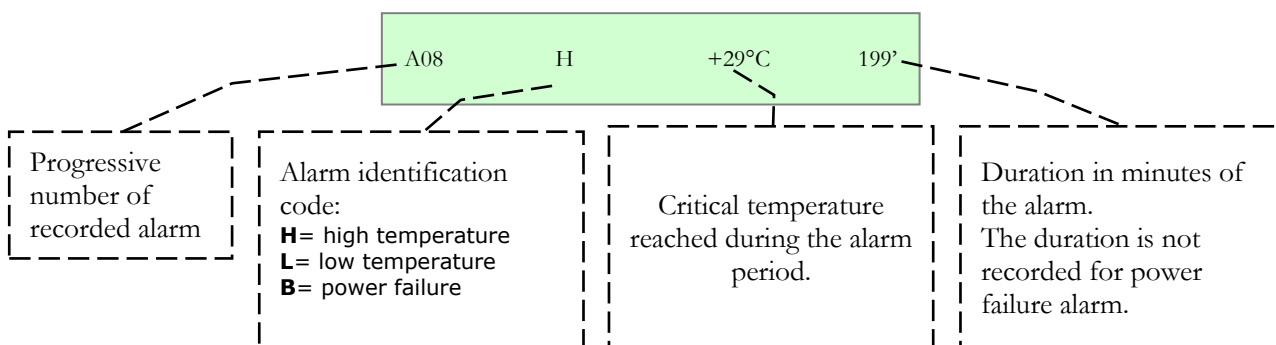



Figure 22 – Information on recorded alarm



Repeatedly press the button  to view the start date/time (S) **S 14:10 24/08/06** and that of the end of the alarm **E 14:34 24/08/06**.

4.3.3.3 How to change temperature alarm limits

Press the button , then use  or  till the following string .

Confirm with the button . The pre-set temperature alarm limits will be visualized and the lower limit will be

blinking too. Change it using the buttons  and , then confirm by pressing the button .

After the lower limit modification, the high temperature alarm limit will start blinking: use the buttons  and  to

modify it and confirm .

Sequence with one probe (a): 

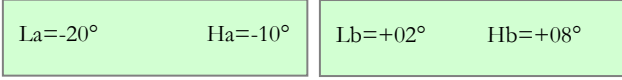

Sequence with two probes (a – b): 







To instantly visualize the pre-set limits press for some seconds the button .



For the models equipped with the ballasted product simulation temperature probe (standard only for Medical devices): for single temperature models equipped with no. 2 probes in the chamber, **Sa** refers to the product temperature simulation probe, whereas **Sb** refers to the air temperature probe.

4.3.3.4 Door openings visualization

Press the button , then use  or  till the following string . Confirm with

the button . The display visualizes the last recorded door opening:

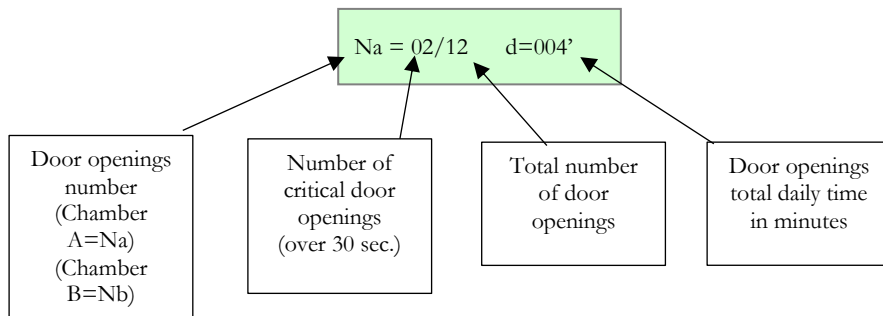





Confirm by pressing , then  and  to select another day 

4.3.3.5 Setting the user password

This menu gives the possibility to set a user password to protect DMLP Digital Monitor switching on/off, setting of high and low temperature limit, date and time changing and accessing to MODE menu.

DMLP Digital Monitor is factory set with password = 00.

Press the button , then use  or  till the following string .

To set the password, press  and select a number from 0 to 255 using  and  buttons. Then, confirm .

To change the password, press the button . The actual password is now required (if any password has been set, the display won't ask it).

Use  or  to enter the password and press . If the password is correct, it's possible to modify the old

one and confirm it by pressing . On the contrary, if password is incorrect, the display will show PASSWORD ERROR and the controller will automatically go to the main menu.



If password is set again to (00), switching on/off, limits and date/time modification won't be protected anymore by password.



BEWARE: IF THE USER PASSWORD IS LOST, THERE IS NO POSSIBILITY TO RETRIEVE IT.

4.3.3.6 Setting the date and time

Press the button , then use  or  till the following string .

Confirm  and the display will blink the actual time. Modify the values using the button  or  and

confirm the new time with . Continue until all the values are set.













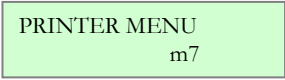

BEWARE: We suggest to set (if necessary) date and time only when the equipment is switched on for the first time, and avoid modifying them later. Changing DMLP Digital Monitor date and time means an immediate erasing of the recorded data, i.e. those referred to the latest 45 days recorded. Data won't be lost anyway, since it will always be stored and available in the SD Card. If you wish to modify date and time, the DMLP Digital Monitor records the date of the last MEMORY RESET and it is possible to access quickly this function through the TEST function.

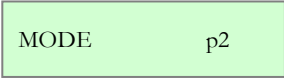

To grant a proper recording, the DMLP Digital Monitor shows in the display the following blinking alarm: **H: 00:00 m 00:00** (clock battery low voltage).

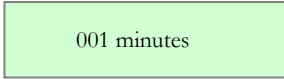

4.3.3.7 Printer menu

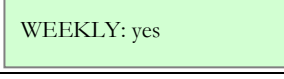
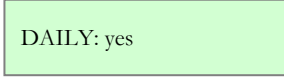
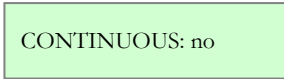
Press the button , then use  or  till the following string . Confirm with button  to access to the print-out customisation:

How to customise the menu:		
		It switches off the printer (“*”) message will appear near STATUS OK)
		It switches on the printer.
		Graphic mode printing.
		Tables mode printing.
		It sets the print resolution in continous or historical mode 1-5-10-15-...etc min.
		It enable/disable the automatic weekly report at 00:00 every Monday
		It enable/disable the automatic daily report at 8:00 o'clock every day (<u>only if alarms have been detected</u>)
		It enable/disable the continuous report, accordingly to the pre-set resolution and mode.

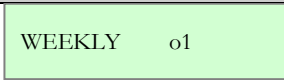
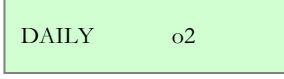
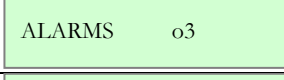
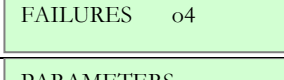
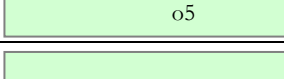

Default configuration:

STATUS: PRINTER ON
 MODE: TABLES MODE
 RESOLUTION: 30 min.
 SETTINGS: WEEKLY: yes
 DAILY: yes
 CONTINUOUS: no

Printing menu:		
		Weekly report with 60 min slot.
		Daily report selected from the menu according to the pre-set mode and resolution.
		Report of all the alarms recorded in the ALARM LIST.
		Report of all the failures recorded in FAILURE LIST.
		Print-out of all the set parameters.
		Report of all the door openings recorded in DOOR OPENINGS menu.

PRINT LIST: WEEKLY

Press  to enter in the Weekly print menu.

Type the beginning date of the report. Start setting the day using  and ; then, confirm by pressing .

Follow the same procedure to set the month and the year till visualizing . To print use .

or  to cancel the operation
Report example:

Alarm 1
It means that from 15:00 to 16:00 an alarm occurred

```

STAMPA SETTIMANALE
S/n 255.255.255
10/09/07 16/09/07

Ora  Lu10  Mo11  We12  Gi13  Ve14  Sa15  Do16
00:00 +4 +4 +4 +4 +4 +4 +4 +4
01:00 +4 +4 +4 +4 +4 +4 +4 +4
02:00 +4 +4 +4 +4 +4 +4 +4 +4
03:00 +4 +4 +4 +4 +4 +4 +4 +4
04:00 +4 +4 +4 +4 +4 +4 +4 +4
05:00 +4 +4 +4 +4 +4 +4 +4 +4
06:00 +5 +5 +4 +4 +4 +4 +4 +4
07:00 +4 +4 +4 +4 +4 +4 +4 +4
08:00 +4 +4 +4 +4 +4 +4 +5 +5
09:00 +4 +5 +4 +4 +4 +4 +4 +4
10:00 +5 +4 +4 +4 +4 +4 +4 +4
11:00 +4 +4 +4 +4 +4 +4 +4 +4
12:00 +4 +4 +4 +4 +4 +4 +4 +5
13:00 +4 +4 +4 +4 +4 +4 +4 +4
14:00 +4 +4 +4 +4 +4 +4 +4 +5
15:00 +4 +4 +4 +4 +4 +4 +4 +4
16:00 +5 +4 +4 +4 +4 +4 +4 +4
17:00 +5 +4 +4 +4 +4 +4 +4 +4
18:00 +4 +4 +4 +4 +4 +4 +4 +4
19:00 +4 +4 +4 +5 +5 +4 +5 +4
20:00 +5 +4 +4 +4 +4 +4 +4 +5
21:00 +5 +4 +4 +4 +5 +4 +4 +4
22:00 +4 +4 +4 +4 +4 +4 +5 +4
23:00 +4 +4 +4 +5 +4 +4 +4 +4

S/n 255.255.255
17/09/07

LISTA ALLARMI
13/09/07 h 15:21 Ha +11°C d=002 min
    
```



Type of print
Serial number of the device
Report beginning and end date.

Automatic print
Alarms list identified by: Alarm code, date and hour, maximum temperature reached and alarm duration

PRINT LIST: DAILY

Press  to enter in the Daily print menu.

Type the date you want to print. Start setting the day using  and ; then, confirm by pressing .

Follow the same procedure to set the month and the year till visualizing . To print use  or .

to cancel the operation. To print another day, press again  and repeat the above steps.

Report example:

```

STAMPA GIORNALIERA BIZZONA
S/n 255.255.255
03/08/07

Data  Ora  Vano A  Vano B
03/08/07 09:54 +04.1° +21.6°
03/08/07 10:04 +04.0° +21.2°
03/08/07 10:14 +03.9° +21.4°
03/08/07 10:24 +04.7° +21.4°
03/08/07 10:34 +04.5° +21.5°
03/08/07 10:44 +03.8° +21.5°
03/08/07 10:54 +04.7° +21.4°
03/08/07 11:04 +04.4° +21.4°
03/08/07 11:14 +05.5° +21.8°
03/08/07 11:24 +03.8° +21.5°
03/08/07 11:34 +04.7° +21.8°
03/08/07 11:44 +04.2° +21.8°
03/08/07 11:54 +05.6° +22.9°
03/08/07 12:04 +03.6° +22.5°
03/08/07 12:14 +04.5° +22.5°
03/08/07 12:24 +03.8° +22.8°
03/08/07 12:34 +05.2° +22.7°
03/08/07 12:44 +03.4° +23.0°
03/08/07 12:54 +04.1° +22.7°
03/08/07 13:04 +03.3° +23.3°
03/08/07 13:14 +04.3° +22.8°
03/08/07 13:24 +03.3° +23.5°
03/08/07 13:34 +03.8° +23.0°
    
```

Tabular report including probe A and B (resolution: 10 min).

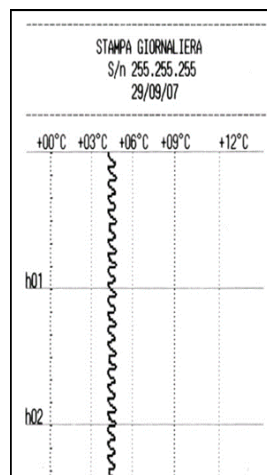

Historical graphical report or continuous.

PRINT LIST: ALARMS



Press to enter in Alarms print menu. The following string appears in the display:

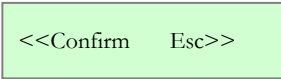

To print use or to cancel the operation

Report example:

```

-----
S/n 255.255.255
17/09/07
-----
LISTA ALLARMI
-----
13/09/07 h 15:21 Ha +11°C d=002 min
08/09/07 h 12:05 Ha +14°C d=011 min
08/09/07 h 12:02 Ha +12°C d=000 min
08/09/07 h 09:25 Ha +13°C d=006 min
08/09/07 h 09:13 Ha +10°C d=001 min
07/09/07 h 14:54 Ba +11°C d=009 min
07/09/07 h 09:47 Ha +10°C d=000 min
06/09/07 h 19:10 Ha +18°C d=016 min
06/09/07 h 11:21 Ha +12°C d=002 min
05/09/07 h 17:33 Ha +05°C d=087 min
    
```

Alarms list specifies:
 alarm code
 date and hour
 maximum temperature
 reached
 alarm duration

Automatic print of alarm

When an alarm is over, an automatic report detailing the alarm is printed:

```

-----
S/n 255.255.255
17/09/07
-----
LISTA ALLARMI
-----
13/09/07 h 15:21 Ha +11°C d=002 min
08/09/07 h 12:05 Ha +14°C d=011 min
08/09/07 h 12:02 Ha +12°C d=000 min
08/09/07 h 09:25 Ha +13°C d=006 min
08/09/07 h 09:13 Ha +10°C d=001 min
07/09/07 h 14:54 Ba +11°C d=009 min
07/09/07 h 09:47 Ha +10°C d=000 min
06/09/07 h 19:10 Ha +18°C d=016 min
06/09/07 h 11:21 Ha +12°C d=002 min
05/09/07 h 17:33 Ha +05°C d=087 min
    
```

Automatic daily alarm report

Every day, only when alarms are detected, a daily alarm report is printed. The report shows the type of alarm, the maximum temperature reached, and the duration of alarm. Daily alarm report example:

```

-----
                STAMPA GIORNALIERA ALLARMI VANO A
                S/n 255.255.255
                08/09/07
-----
ALTA TEMP. NO RETE: max +11* Durata 009'
ALTA TEMPERATURA : max +10* Durata 000'
-----
Limiti senza variazioni: +00*/+10* R 000'
-----

```

PRINT LIST: FAILURES

Press  to enter in Failures print menu. The following string appears in the display:

```
<<Confirm  Esc>>
```

To print use  or  to cancel the operation.

Report example:

```

-----
                S/n 255.255.255
                17/09/07
-----
                LISTA GUASTI
-----
07/09/07 14:39 GUASTO RETE
07/09/07 09:20 GUASTO RETE
06/09/07 18:54 GUASTO RETE
06/09/07 11:10 SWITCH
06/09/07 09:39 SONDA Sa
06/09/07 09:39 SONDA Sa
06/09/07 09:39 BATTERIA ASSENTE
06/09/07 09:38 BATTERIA ASSENTE
05/09/07 19:05 GUASTO RETE
05/09/07 19:05 BATTERIA ASSENTE
05/09/07 19:04 BATTERIA ASSENTE
05/09/07 17:08 SONDA Sb
05/09/07 16:59 SONDA Sb

```

Failure list report details :
date and hour
failure type

PRINT LIST: PARAMETERS



Press to enter in Parameters print menu. The following string appears in the display:

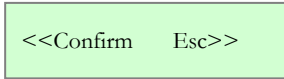

To print use or to cancel the operation. Report example:

```

-----
S/n 255.255.255
17/09/07
-----
PARAMETRI
-----
ADR 000 flg IOS 245 flg CA1 +0.0 °C
CA2 +0.0 °C DAA 060 min DSA 000 min
LAA -00 °C HAA +10 °C DAB 060 min
DSB 001 min LAB -00 °C HAB +10 °C
BUR 015 min BOD 010 min BAT 001 flg
TRB 012 ora PRE 000 flg RES 030 min
DOA 030 sec DOB 030 sec ROL 000 flg
UMT 000 flg PSC 000 flg SNA 001 flg
SNB 001 flg
    
```

Parameters list report:
it prints DMLP Digital Monitor parameters

PRINT LIST: DOOR OPENINGS



Press to enter in Door openings print menu. The following string appears in the display:

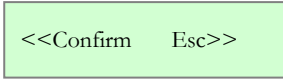

To print use or to cancel the operation. Report example:

```





-----
S/n 255.255.255
17/09/07
-----
APERTURE VANO A
-----
15/09/07 TOT n^005/001 min; n^002>030 sec
14/09/07 TOT n^003/000 min; n^000>030 sec
13/09/07 TOT n^031/005 min; n^002>030 sec
12/09/07 TOT n^001/000 min; n^000>030 sec
8/09/07 TOT n^014/012 min; n^005>030 sec
7/09/07 TOT n^020/003 min; n^005>030 sec
6/09/07 TOT n^019/009 min; n^005>030 sec
5/09/07 TOT n^002/007 min; n^002>030 sec
    
```

Door openings list report details:
date and hour
total number of door openings
total duration of door openings
number of critical door openings (>30 sec.)

4.3.3.8 Service Menu

Only Technical support can enter in Service menu. This menu is password protected.

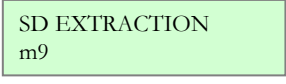
4.3.3.9 How to remove SD card

Press the button , then use  or  till the following string . Confirm 

Confirm and remove the SD card within 60 seconds by pressing on it with a finger. Insert the SD card inside the supplied Card Reader and connect the device to the USB port of a PC. Install the software “SD Card Reader Capture” executing the file “Setup.exe” and follow the instructions on the screen. Once installation is finished:

- 1 Open “SD Card Reader Capture” software
- 2 Enter the date of beginning/end
- 3 Select the information required
- 4 Click on “browse”
- 5 Click on “DATALOG.bin” folder (which is inside SD Card memory)



For a backup of the data, open the SD Card contents and make a copy of the file “DATALOG.bin”: Pay attention not to cancel or move the file erroneously. This operation could definitely damage the data recorded on the SD Card.

After loading all necessary Data/Records (this operation may take some minute), it is possible:

- To analyse data in the table
- To export data to a “Data file” for processing them with other programs (e.g. Excel...)
- To create immediately daily temperature graphs.

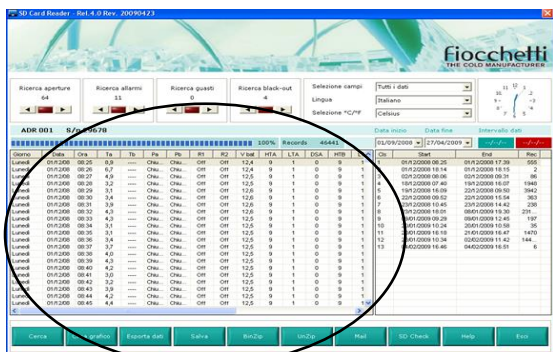

Data in the table

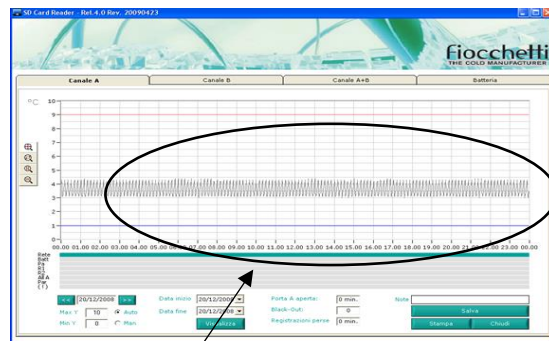

Daily temperature graph



The SD card position is identified by a sticker:
 - In the rear for models with the engine at the bottom;
 - In the upper part in the models with the motor up;
 - On the left side for models 140 and 280 2T.





ATTENTION: When SD Card is removed from its slot (following the above procedure), all data will be saved any way in the DMLP Digital Monitor memory for a maximum of 120 minutes. Upon the re-insertion of the SD card in its slot, all the saved data will be automatically stored in SD Card, while those referred to the exceeding (above 120 minutes) time will be definitely lost. **So, to get a complete historical data logging, it is advised not to extract the SD Card for a longer time-span than indicated.**







We suggest saving at least once a month the data registered in the SD Card to grant data availability also in case of SD card lost or damaged.

4.3.3.10 How to modify the language

Press the button , then use  or  till the following string .



Using these buttons   select the desired language and confirm by pressing :

- 
- 
- 
- 
- 



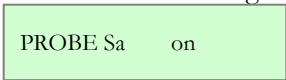

4.3.3.11 How to modify compartment functions (only for double temperature equipment)

This function allows to exclude one of the two compartments, disabling the alarm signalizations if the chamber is faulty or not in use.

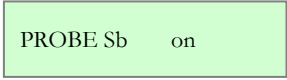

Press the button , then use  or  till the following string .

Once confirmed , the display will show: . Using the button  or , you can

visualise the other probe's compartment: .

Confirming with the button  on the wished compartment ("a" = upper/left; "b"= lower/right), the string "on" will start blinking. Use the button  or  to select "off", then confirm .

The display will now show a message asking to confirm or to exit from the Menu with the message: . Confirm again

with the button . The display will show message  and it will go back to the main menu. The following symbol "*" next to STATUS OK means that DMLP Digital Monitor has been disabled.

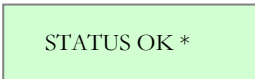

4.3.3.12 Special function: TEST

Press  for some seconds to activate the function TEST. This function checks the integrity of the alarm system, running a test of the following functions:

- Battery charge test
- Buzzer integrity (continuous sound for 4 sec.)
- Acoustic and visual simulation of the low temperature alarm (Probe a)
- Acoustic and visual simulation of the high temperature alarm (Probe a)
- Acoustic and visual simulation of the low temperature alarm (Probe b) (if installed)
- Acoustic and visual simulation of the high temperature alarm (Probe b) (if installed)
- Door micro-switch integrity (the display will ask to open and close the door)
- Dry contacts test
- Latest memory reset test

4.3.4 ALARM AND FAILURE SIGNALS

4.3.4.1 Fault in progress warning

In the event of any system abnormality, an audible and visual warning is immediately signalled to the user by means of the flashing display and the sound of the buzzer. Then, the alarm is registered in ALARMS LIST. The DMLP Digital Monitor records the latest 16 alarms along with the following information:

TYPE OF ALARM**CRITICAL TEMPERATURE REACHED**

DATE/TIME of alarm beginning

DURATION of the alarm (only for high/low temperature alarm and power failure)

It is possible to mute the buzzer by pressing any of the DMLP buttons. After 15 minutes, if the problem has not been solved, the DMLP Digital Monitor buzzer will re-activate automatically.

The display warns the user with the following messages:

- High temperature (T)
- Door ajar (P)
- Functional failure (G)
- Power failure (E)
- Information (I)

The faults that the controller can detect are as follows:

MESSAGE	T	TYPE OF FAULT IN PROGRESS
HIGH TEMP	T	Pre-alarm of high temperature or high temperature alarm (blinking and buzzer)
HIGH TEMP a	T	Pre-alarm of high temperature or high temperature alarm (blinking and buzzer) - chamber A
HIGH TEMP b	T	Pre-alarm of high temperature or high temperature alarm (blinking and buzzer) - chamber B
LOW TEMP	T	Pre-alarm of low temperature or low temperature alarm (blinking and buzzer)
LOW TEMP a	T	Pre-alarm of low temperature or low temperature alarm (blinking and buzzer) - chamber A
LOW TEMP b	T	Pre-alarm of low temperature or low temperature alarm (blinking and buzzer) - chamber B
DOOR OPEN	P	Door open alert or door open alarm (blinking and buzzer)
DOOR a OPEN	P	Door open alert or door open alarm (blinking and buzzer) – chamber A
DOOR b OPEN	P	Door open alert or door open alarm (blinking and buzzer) – chamber B
DOOR SWITCH	G	Micro-switch possible faulty (for one or both doors)
PROBE S1	G	Probe failure S1
PROBE S2	G	Probe failure S2
SD REMOVED	G	SD card enabled but absent
SD PROTECTED	G	SD card enabled but protected
SD INVALID	G	SD card not recognized
SD EXTRACTION	I	SD card should be removed within a minute
INSERT SD	I	SD card has been removed but not inserted yet in its slot
NO BATTERY	G	Battery discharged or disconnected
BATTERY FAILURE	G	Vattery voltage < 7,0 V after the recharging
NO MAINS	E	Power failure or plug disconnected
MAINS FAILURE	E	Power failure
PRINTER STOPPED	I	Printing has been stopped (during the printing any button has been pressed)
PRINT STOPPED	I	Print request with low power or power failure

Table 8 – Faulty conditions detected by DMLP

4.3.4.2 Fault ended warning

When the alarm condition is finished, the display will alternately visualise the message ALARM NOTICED with the standard pre-set display until the user accesses the alarm list menu.

5

ROUTINE AND SPECIAL MAINTENANCE

The information in this chapter is addressed to both users (non-specialised personnel) and routine maintenance workers.

5.1 PROHIBITION OF SAFETY DEVICE REMOVAL

Do not remove safety protections without having switched off the refrigerator cabinet and disconnecting it from the electrical mains.

The manufacturer disclaims all liability that may arise if this regulation is not observed.

5.2 CLEANING THE UNIT INSIDE AND OUTSIDE

We recommend cleaning both inside and outside surfaces of the unit at least twice a year. Disconnect the power cord before any cleaning.

The following is indicated for this purpose:

- Cleaning products: water and non-abrasive neutral detergents. **DO NOT USE SOLVENTS OR THINNERS.**
- Cleaning method: use a cloth or sponge soaked in a suitable cleaning product to clean the inside and outside parts of the cabinet.
- Disinfection: do not use substances that can alter the organoleptic characteristics of stored products.
- Rinsing: use a cloth or sponge soaked in water. **DO NOT USE WATER JETS.**
- Frequency: at least twice a year or at different intervals depending on the type products stored.

5.3 CLEANING THE CONDENSER

Failure to clean the condenser, as well as temperature being too high in the environment in which it is installed, is one of the main causes of difficult cabinet operation. Cleaning must be carried out every 2-3 months, even in the cleanest environments.

You must access the condenser coil, placed in all models in the technical compartment near the compressor, and clean it with one of the following:

- Long bristle brush
- Vacuum cleaner
- Compressed air



**DO NOT USE METAL BRUSHES
DO NOT BEND CONDENSER FINS**



**CAUTION:
ALWAYS DISCONNECT THE POWER CORD BEFORE THIS OPERATION.**

In order to ensure optimal unit operation, follow the manufacturer instructions, arranging for periodic maintenance to be carried out by qualified technicians.

Follow these below cleaning instructions according to the bought model:

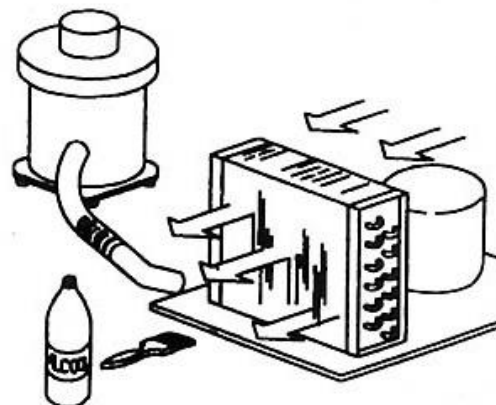

Figure 23 – Representation of condenser

MODEL 100-140-280 2T

PHASE 1

Use a Phillips head screwdriver to remove the cover (if the battery pack cover is present, do not remove the screws to the right and left of the terminal board or those for fixing the cover itself).

For model 280 2T, also remove the rear electrical wiring cover channel.

PHASE 2

Use a vacuum cleaner or air jet to remove any dust on the condenser fins.

Perform this procedure backwards to restore correct fastening of the rear cover.

PHASE 3

Restore the electrical current and switch back on the device.

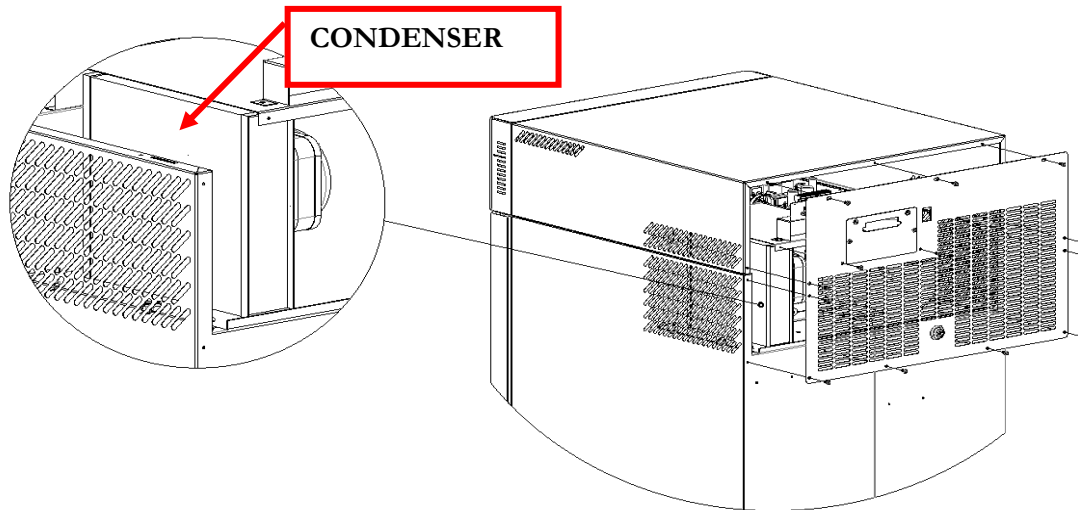

Figure 24 - Condenser position in models 100-140-280

MODEL 130-170-200-250-300-600 2T-400-500 (1T and 2T)

PHASE 1

Use a Phillips head screwdriver to remove the guard (3 screws).

PHASE 2

Use a vacuum cleaner, air jet, or a long bristle brush to remove any dust on the condenser fins.

Perform this procedure backwards to restore correct fastening of the guard.

PHASE 3

Restore the electrical current and switch back on the device.

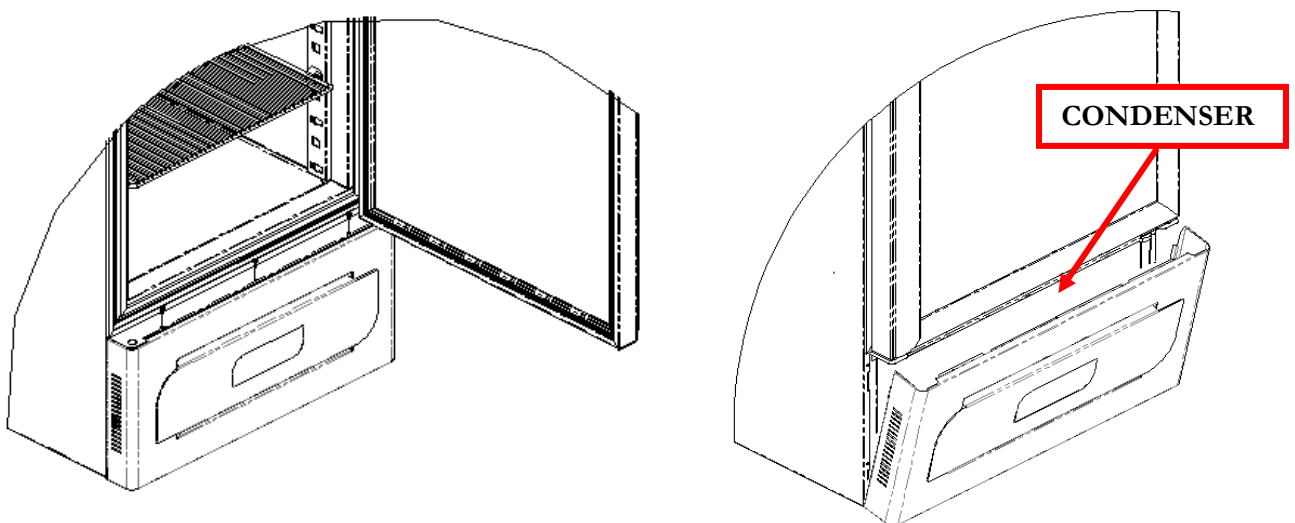

Figure 251 - Condenser position in models with lower compartment motor

MODEL 700-1500**PHASE 1**

In models with higher motors (700-1500 L), the condenser can be accessed directly from the outside using a ladder.

PHASE 2

Use a vacuum cleaner, air jet, or a long bristle brush to remove any dust on the condenser fins.

PHASE 3

Restore the electrical current and switch back on the device.

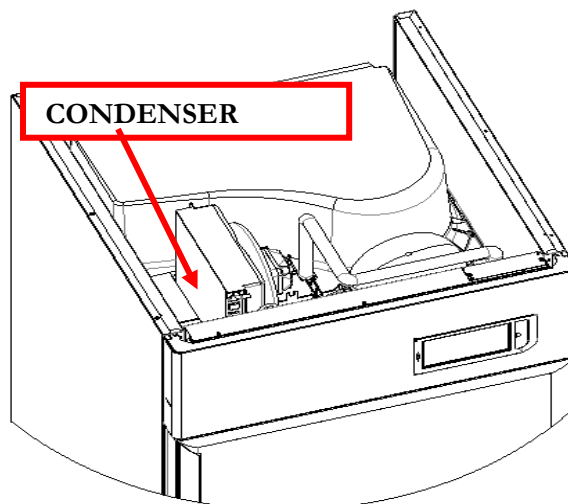

Figure 26 - Condenser position in models 700-1500

5.4 CONDENSATE WATER DRAINING

Defrosting causes the formation of condensate water. The water evaporates automatically in models with motor compartment in lower position.

In some other models, water is collected in a tray, included in supply, which is set under the unit and inserted in the corresponding slides.

This tray must be emptied frequently

Optionally, models with upper motor compartment can have a collecting tray included for automatic condensation water evaporation.

List of Models with upper motor:

EMOTECA TWIN	700 – 1500
SUPERARTIC	700 – 700 2T
PLASMA SUPERARTIC	700 – 700 2T
LABOR	700 2T
PLASMA LABOR	700 2T
SPARK-PROOF	400 – 700

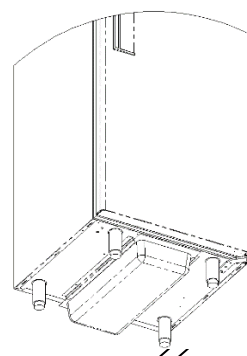

Figure 27 - Condensate collection tray position

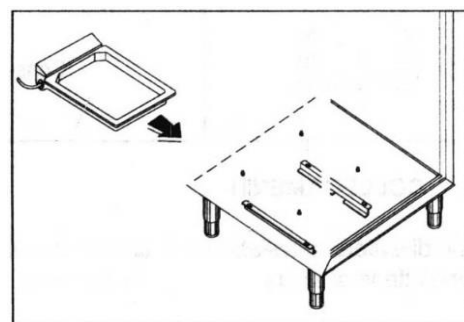



Figure 28 - Tray with automatic condensate water evaporation

This unit is marked in compliance with European Directive 2012/19/UE (WEEE).



The symbols  on the product means that it must not be considered as domestic waste but it must be given to the competent authority for the recycling of electric and electronic appliances.

Before scrapping the machine, make it unusable by cutting the power cord, and removing the doors, shelves and drawers so that children cannot access the unit. Do not leave it unattended even for a few days.

For further information about the treatment, retrieval and recycling of the product, please contact local officials, the domestic waste collection service or the distributor.

Please comply with applicable laws.

The gas present into the system must be extracted by authorised personnel.

The following documents are attached:

- Declaration of conformity with DIRECTIVE 2006/42/EC
- Declaration of conformity with DIRECTIVE 2014/30/EC
- Declaration of conformity with DIRECTIVE 2014/35/EC
- Declaration of conformity with DIRECTIVE 2011/65/EC (RoHS) (on request)
- Declaration of conformity with DIRECTIVE 93/42/ECC (For Medical Devices only)
- Electric safety check receipt
- Wiring diagram

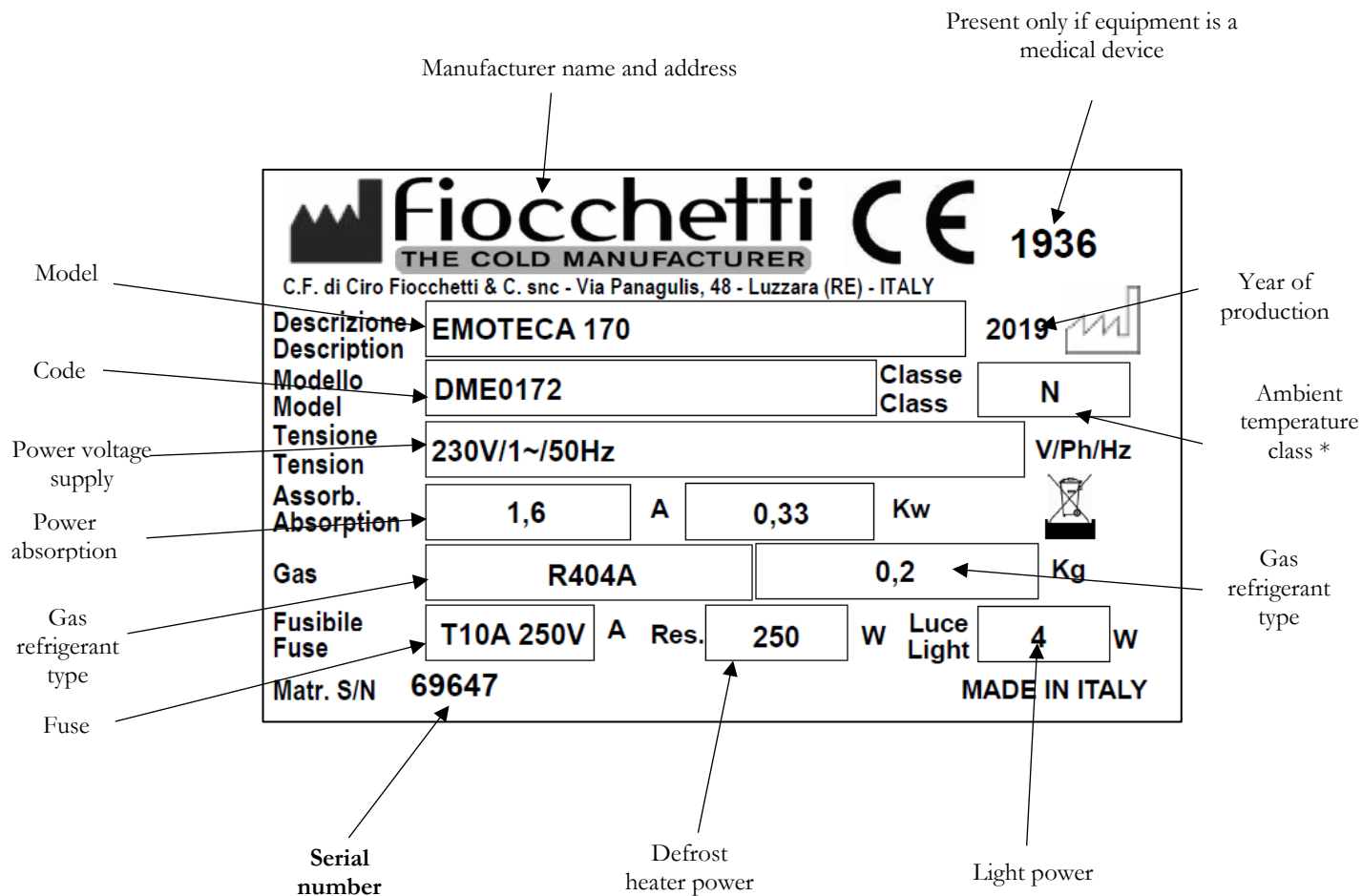
8.1 MACHINE DATA PLATE

*Ambient temperature class :

SN (from +10°C to +32°C)

N (from +16°C to +32°C)







ST (from +18°C to +38°C)

T (from +18°C to +43°C)

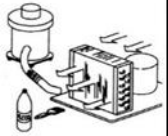
C (from +10°C to +25°C)





8.1.1 OTHER LABELLING

Table 9 - Labels

 <p>PRIMA DI APRIRE LA PROTEZIONE TOGLIERE LA TENSIONE TURN OFF AND UNPLUG AC BEFORE OPENING COVER AVANT D'OUVRIR LA PROTECTION ÔTER LA TENSION BEVOR DER SCHUTZ ZU OEFFNEN, ZU ENTSPANNEN</p>	<p>Cut off power before removing the guard.</p>																								
<p>ATTENZIONE TENERE PULITO IL CONDENSATORE</p>  <p>ATTENTION KEEP THE CONDENSER CLEAN</p>	<p>Periodic condenser cleaning</p>																								
	<p>Earthing symbol</p>																								
	<p>Attention: risk of fire (only when natural refrigerants are used)</p>																								
<p>ATTENZIONE: VETRO INTERNO CON PELLICOLA ANTICONDENSA PULIRE TASSATIVAMENTE SOLO CON ACQUA</p> <p>ATTENTION: INTERNAL GLASS WITH ANTI-FOG FILM CLEAN ONLY WITH WATER</p> 	<p>Glass door cleaning for Vision models</p>																								
	<p>Do not exceed the indicated level</p>																								
<p>ATTENZIONE SOSTITUIRE LA BATTERIA OGNI 24 MESI</p> <p>ATTENTION CHANGE BATTERY EVERY 24 MONTHS</p> 	<p>Substitute batteries (only with DMLP Digital Monitor)</p>																								
<table border="1" data-bbox="255 1321 805 1433"> <tr> <td>no</td><td>c</td><td>nc</td><td>no</td><td>c</td><td>nc</td><td>-</td><td>+</td><td>-</td><td>+</td><td>-</td><td>+</td> </tr> <tr> <td colspan="3">AL1</td><td colspan="3">AL2</td><td colspan="2">RS485</td><td colspan="2">4-20 mA A</td><td colspan="2">4-20 mA B</td> </tr> </table>	no	c	nc	no	c	nc	-	+	-	+	-	+	AL1			AL2			RS485		4-20 mA A		4-20 mA B		<p>External dry contacts+RS485 label</p>
no	c	nc	no	c	nc	-	+	-	+	-	+														
AL1			AL2			RS485		4-20 mA A		4-20 mA B															

9 CONSUMABLE MATERIALS

Table 10 - Consumable materials

Code	Type/Characteristics	Application	Image
BAT004	BATTERIA 3V Lithium Coin Cell Battery type CR 1220	ECT-F Control and DMLP Digital Monitor clock battery	
BAT001	12V 2.1 Ah Lead battery	DMLP Digital Monitor Battery	
BAT003	Lead battery 12V 1.2 Ah	Web Light Server Battery	
ROT007	Thermal paper (2 pcs/each package)	DMLP Printer	

The table below lists information regarding the possible causes and actions to be taken for the most common faults, which do not need automatically technical servicing.

Servicing on the electrical system must also be carried out by trusted electricians.

PROBLEM	POSSIBLE CAUSE	SOLUTION
The unit does not switch on.	<ul style="list-style-type: none"> • Controller set to “Stand-by” 	<ul style="list-style-type: none"> • Switch on the controller.
	<ul style="list-style-type: none"> • No mains 	<ul style="list-style-type: none"> • Check the plug, outlet, fuses and electrical line.
	<ul style="list-style-type: none"> • Power plug not connected to the electrical outlet. 	<ul style="list-style-type: none"> • Connect the power cord to the electrical socket.
	<ul style="list-style-type: none"> • Control panel fault 	<ul style="list-style-type: none"> • Contact Technical Support.
Unit does not reach the set temperature.	<ul style="list-style-type: none"> • Too much material has been placed in the compartment 	<ul style="list-style-type: none"> • Reduce the quantity and leave space between the shelves and walls. • Place products in the cabinet a few at a time after the temperature has stabilised.
	<ul style="list-style-type: none"> • Material was placed in the freezer area at room temperature (i.e. +25°). 	<ul style="list-style-type: none"> • Store only already frozen products.
	<ul style="list-style-type: none"> • Prolonged or too frequent door openings 	<ul style="list-style-type: none"> • Reduce door openings and close the door more quickly.
	<ul style="list-style-type: none"> • Ambient temperature is too high. 	<ul style="list-style-type: none"> • Air condition the environment.
	<ul style="list-style-type: none"> • Condenser clogged by dust or dirt. 	<ul style="list-style-type: none"> • Clean the condenser.
	<ul style="list-style-type: none"> • Electronic controller operating fault 	<ul style="list-style-type: none"> • Contact Technical Support.
	<ul style="list-style-type: none"> • Cooling system operating fault 	<ul style="list-style-type: none"> • Contact Technical Support.

PROBLEM	POSSIBLE CAUSE	SOLUTION
The unit is noisy	<ul style="list-style-type: none"> Unit instability 	<ul style="list-style-type: none"> Eliminate the cause.
	<ul style="list-style-type: none"> Contact with objects (e.g. cardboards, polystyrene or other materials) 	<ul style="list-style-type: none"> Move and/or remove objects touching the equipment.
Repeated alarm or fault signals or alarm noticed	<ul style="list-style-type: none"> Unit has detected an alarm. 	<ul style="list-style-type: none"> Visualize alarms (see par. 5.2.4.2)
Products wet	<ul style="list-style-type: none"> Formation of ice in the evaporator or sudden defrosting 	<ul style="list-style-type: none"> Contact Technical Support.
	<ul style="list-style-type: none"> High humidity level in the environment 	<ul style="list-style-type: none"> Air condition or ventilate the environment.
Glass door wet	<ul style="list-style-type: none"> High humidity level in the environment 	<ul style="list-style-type: none"> Air condition or ventilate the environment.
DMLP Digital Monitor SD card doesn't record	<ul style="list-style-type: none"> Display in "Stand-by" 	<ul style="list-style-type: none"> Turn on the DMLP Digital Monitor (par. 5.3.1)
	<ul style="list-style-type: none"> Display not in "STATUS OK" 	<ul style="list-style-type: none"> Press "OK" till activating "STATUS OK" mode (par. 5.3.2)
	<ul style="list-style-type: none"> Date and time not set correctly 	<ul style="list-style-type: none"> Check date and time (par. 5.3.3.6)

11

DIAGNOSTIC

The table below lists information regarding the possible causes and actions to be taken for the most common faults, which do not need automatically technical servicing.

Servicing on the electrical system must also be carried out by trusted electricians.

VISUAL AND ACOUSTIC ALARM	SOLUTION
LOW EVAPORAT	<ul style="list-style-type: none"> Switch off the refrigerator from the keyboard -STAND BY (see par. 5.2.3.1). Then, disconnect the electrical plug, wait a few seconds and then re-connect the plug. Switch the refrigerator back on from the keyboard and, once the temperature is displayed, press "OK" so that the acoustic and visual alarms disappear.
	<ul style="list-style-type: none"> Check that door is properly closed.
	<ul style="list-style-type: none"> If the problem persists, contact Technical Support.

VISUAL AND ACOUSTIC ALARM	SOLUTION
HIGH CONDENS	<ul style="list-style-type: none"> • Switch off the refrigerator from the keyboard -STAND BY (see par. 5.2.3.1). Then, disconnect the electrical plug, wait a few seconds and then re-connect the plug. Switch the refrigerator back on from the keyboard and, once the temperature is displayed, press "OK" so that the acoustic and visual alarms disappear. •
	<ul style="list-style-type: none"> • Air condition the environment.
	<ul style="list-style-type: none"> • Check that installation has been properly performed (see par. 4.2)
	<ul style="list-style-type: none"> • Clean the condenser (see par. 6.3)
	<ul style="list-style-type: none"> • If the problem persists, contact Technical Support.

VISUAL AND ACOUSTIC ALARM	SOLUTION
COMPRES WORK.	<ul style="list-style-type: none"> • Air condition the environment.
	<ul style="list-style-type: none"> • Clean the condenser (see par. 6.3)
	<ul style="list-style-type: none"> • Check that installation has been properly performed (see par. 4.2)
	<ul style="list-style-type: none"> • Switch-off the equipment from keypad (see par. 5.2.3.1) and then, switch it on again.
	<ul style="list-style-type: none"> • Check that door is properly closed.
DEFROST TIME	<ul style="list-style-type: none"> • Switch-off the equipment from keypad (see par. 5.2.3.1) and then, switch it on again.
	<ul style="list-style-type: none"> • Check ambient conditions (environment should be neither too hot nor too cold).
	<ul style="list-style-type: none"> • Check that installation has been properly performed (see par. 4.2)
	<ul style="list-style-type: none"> • If the problem persists, contact Technical Support.
HIGH TEMP alarm	<ul style="list-style-type: none"> • Check that products have been correctly stored in the chamber (see par. 4.6.3)
	<ul style="list-style-type: none"> • Check ambient conditions (environment should be neither too hot nor too cold).
	<ul style="list-style-type: none"> • Clean the condenser (see par. 6.3)
	<ul style="list-style-type: none"> • Check that door is properly closed.
	<ul style="list-style-type: none"> • Air condition the environment.
LOW TEMP alarm	<ul style="list-style-type: none"> • Contact Technical Support.
POWER FAIL HT	<ul style="list-style-type: none"> • Check the alarms list.
	<ul style="list-style-type: none"> • Check the electrical system or accidental disconnection of the plug.
H 00:m00	<ul style="list-style-type: none"> • Replace button battery on electronic board.
NO BATTERY (only if DMLP Digital Monitor is installed)	<ul style="list-style-type: none"> • Replace the battery.
BATTERY FAILURE (only if DMLP Digital Monitor is installed)	<ul style="list-style-type: none"> • Replace the battery.
PROBE S1-S2-S3-S4	<ul style="list-style-type: none"> • Contact Technical Support. Refrigerator functioning is guaranteed anyway.

VISUAL AND ACOUSTIC ALARM	SOLUTION
SD INVALID	<ul style="list-style-type: none"> Switch off the DMLP Digital Monitor on keypad (par.5.3.3.1) and remove the SD Card from its slot. Disconnect the equipment from the mains for some seconds and re-connect it using the keyboard. When “SD REMOVED” message appears in the screen, insert again the SD Card.
	<ul style="list-style-type: none"> If the problem persists, contact Technical Support.
PRINTER STOPPED	<ul style="list-style-type: none"> Check that thermal paper has been properly installed.
	<ul style="list-style-type: none"> Using TEST function (par. 5.3.3.12) check the instant battery printer voltage (if voltage <11Volt, wait for 24 h and run a second test if voltage is still <11 Volt, replace the battery cod. BAT001)
	<ul style="list-style-type: none"> If the problem persists, contact Technical Support.
AUXIL PLANT (only for Twin models)	<ul style="list-style-type: none"> Switch off the device from keypad (par. 5.2.3.1) and disconnect it from the mains for some seconds. Then, switch it on again (5.2.1).
	<ul style="list-style-type: none"> If the problem persists, contact Technical Support.

Annex 1

USER DATA FOR TECHNICAL SUPPORT REQUEST

Please fill in the following tables in order to provide all data necessary for Technical support. If possible, leave the refrigerator in operation for 1 hour or, even better, 24 hours to allow the controller to fully collect information.

MODEL*:	SERIAL NUMBER*:
----------------	------------------------

Device traceability, see the silver plate at the end of this manual

- 1) Has periodic cleaning of the condenser been carried out as per the use and maintenance manual? YES No
If Yes, indicate the date of the last cleaning and the names of personnel who performed it.
- 2) Have the problems been verified according to the information stated in the use and maintenance manual?
YES No

Fill out the following table.

Equipment:	yes	no
- Does not cool		
- Does not reach the set temperature		
- Does not switch on		
- Equipment built into furniture		
- Power cable connected to multiple sockets or adapters of the power outlet		
- THE REFRIGERATOR UNIT IS NOISY		
- DISPLAY OFF		
The Display signals:	yes	no
- Evaporator		
- Condenser		
- No battery		
- Battery failure		
- Comp. work		
- Invalid SD		

Table 11 - Fault signal table

Notes:



SENT ON:	SIGNATURE: (legible)
-----------------	--------------------------------

via e-mail to assistenza@fiocchetti.it

Note: failure to submit a properly completed request (*required fields) will result in a failure to open servicing with a resulting delay in the resolution of issues.

Annex 2

SERVICE DATA FOR TECHNICAL SUPPORT ON ECT-F PLUS CONTROLLER

Enter into the service section SERVICE MENU, confirm with  and enter password 255. Enter into the “status data” menu with  and scroll the items, noting the values in the table below.

<i>Item</i>	<i>Value</i>	<i>U.M.</i>
KEYPAD ON		n
POWER ON		n
RESET		h
ECT-F		h
COMP		h
COMP%		%
COMP%		%
COMP ON		“
COMP OFF		“
Max Evap		°C
Min Evap		°C
DTM Cond		°C
Max Cond		°C
Min Cond		°C

Service status data for support

N	FAULT	DATE/HOUR
F01		
F02		
F03		
F04		
F05		
F06		
F07		
F08		
F09		

Faults list for assist

Space reserved for the data sheet with the characteristics of the appliance



Space reserved for the stamp of the distributor

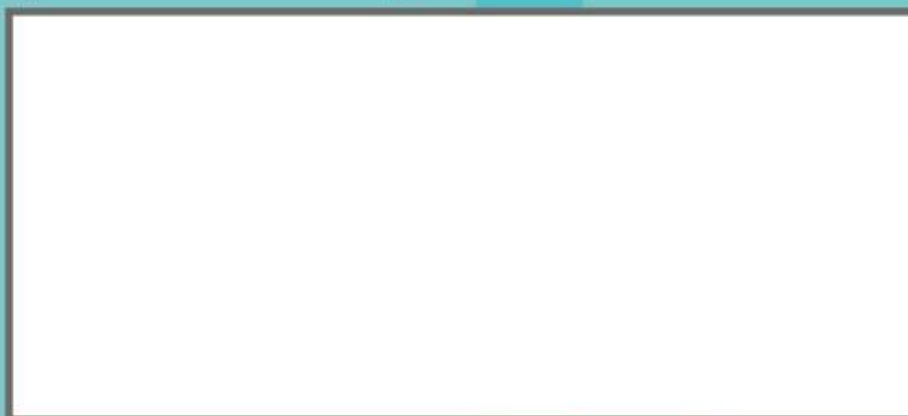

fiocchetti
THE COLD MANUFACTURER

C.F di Ciro Fiocchetti & C. s.n.c.

Via Panagulis, 48 42045 Luzzara (RE) - Italy

tel. +39 0522 976232 - fax +39 0522 976028

www.fiocchetti.it - info@fiocchetti.it

MNL004_ITA rev. F