



## CO<sub>2</sub> Incubators CO<sub>2</sub> /O<sub>2</sub> Multi-gas Incubators



50 L

### Optimising cell culture outcomes and reproducibility

PHCbi CO<sub>2</sub> Incubators provide precise control of CO<sub>2</sub>\* concentrations and accurate, uniform, and highly responsive temperature control within the chamber. During cell culturing, contamination is prevented by the germicidal interior and optional UV lamp. Time-saving decontamination is realised by H<sub>2</sub>O<sub>2</sub> option.

#### Easier to Clean

The slide-out perforated stainless steel shelves rest securely in integrated shelf channels molded into the left and right sidewalls, eliminating the need for troublesome shelf brackets and clips. Molded shelf channels reduce the amount of interior parts by up to 70%. Perforated shelves promote natural temperature and gas uniformity.

#### Unified Controller

A central intuitive control panel with graphic user interface simplifies operation and improves visibility of key performance parameters. An OLED input/output display creates an ergonomically-friendly selection of all functions including temperature and CO<sub>2</sub>\* setpoints and alarm deviation limits for temperature and CO<sub>2</sub>\*. A USB data port permits downloading logged performance and event information.

#### Precision Gas Sensors IR CO<sub>2</sub> and Zirconia O<sub>2</sub>\*

The IR CO<sub>2</sub> sensor offers continuous calibration for excellent control and accuracy. This ceramic sensor is not affected by moderate temperature and humidity changes and is linked to the P.I.D. controller for fast recovery. As CO<sub>2</sub> and pH levels are key components for proper tissue culture, "Real Time" recovery and monitoring of CO<sub>2</sub> levels provide better culture outcomes. A zirconia O<sub>2</sub> sensor controls oxygen within a 1-18% / 22-80% range.



#### Optimal Cell Growth

The inCu-saFe® copper-enriched stainless steel alloy creates an internal germicidal barrier against airborne contaminants. Unlike pure copper, the inCu-saFe® surface will not discolour or corrode due to CO<sub>2</sub>\* exposure over time. An optional UV lamp automatically destroys airborne contaminants through serial dilution of air that gently circulates through a rear plenum. An optional H<sub>2</sub>O<sub>2</sub> vapor nebuliser saves time when total incubator decontamination is required.



#### Event Management

The microprocessor controller manages all incubator functions and user inputs through an arrow prompted menu. Notifications include actual temperature, actual CO<sub>2</sub>\*, door status, UV status and deviation alarms. The CO<sub>2</sub> sensor maintains setpoint to within 0.1% and eliminates any need for periodic calibration. With model MCO-50M precision CO<sub>2</sub> and O<sub>2</sub> sensors maintain the set point to within 0.2% or better, and require only minimal calibration.



#### Reproducibility by Elimination of External Factors

Reduction of interior parts and condensation control by Peltier powered dew stick helps minimise external factors that often complicate efforts to reproduce cell culture and other protocols. Stable temperature is maintained by the Direct Heat and Air Jacket system. CO<sub>2</sub>\* is quickly restored to set-point after door openings, while relative humidity returns to an elevated state to prevent media desiccation.

\*also O<sub>2</sub> with model MCO-50M

## Time-Saving Decontamination

The high-speed decontamination system uses vaporised hydrogen peroxide and UV light. It cleans the chamber of the incubator safely in less than 3 hours, achieving a minimal 6 log reduction of major contaminants.

### Performance Data\*

#### Temperature pull-down/pull-up characteristics (50AIC(L) / 50M)

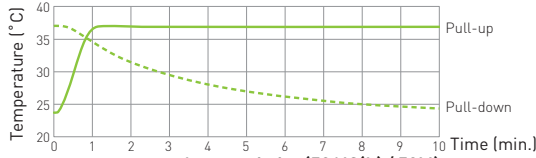

#### Temperature recovery characteristics (50AIC(L) / 50M)

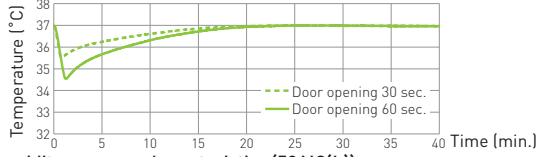

#### Humidity recovery characteristics (50AIC(L))

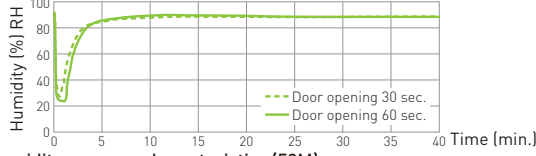

#### Humidity recovery characteristics (50M)

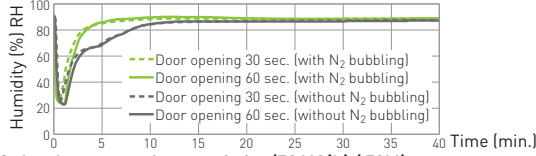

#### CO2 level recovery characteristics (50AIC(L) / 50M)

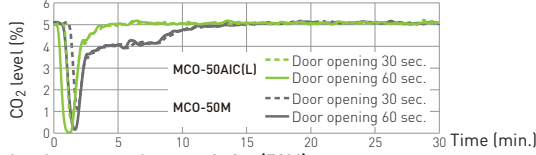

#### O2 level recovery characteristics (50M)

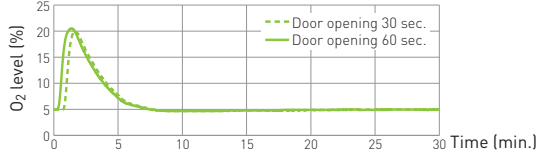

\* MCO-50AIC(L) Ambient temperature: 23°C, setting: 37°C, CO<sub>2</sub>: 5%, no load

\* MCO-50M Ambient temperature: 23°C, setting: 37°C, CO<sub>2</sub>: 5%, O<sub>2</sub>: 5%, no load

### Dimensions

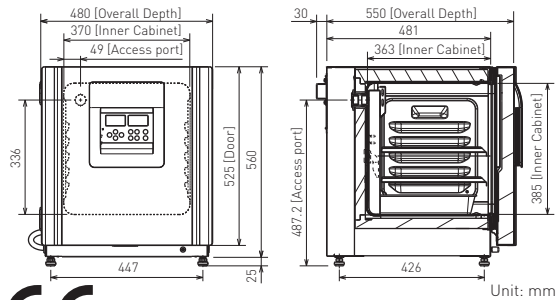

220-240 V 50/60 Hz only



Preservation Equipment, Experimental Environment Equipment, Dispensary Equipment, Culturing Equipment and Drying & Sterilising Equipment for General Laboratory use

The management of the design, development, production and servicing of the above.



Freezers, Refrigerators, Incubators, and Drying and Sterilising Equipment for Medical use

The management of the design, development, production and distribution of the above.



PHC Corporation Biomedical Division is certified for:  
Environmental management system: ISO14001

PHC Corporation, Biomedical Division 1-1-1 Sakada, Oizumi-machi, Ora-gun, Gunma 370-0596, Japan

DISTRIBUTED BY:

Model Number	MCO-50AIC / MCO-50AICL	MCO-50M
External dimensions (W x D x H) <sup>1)</sup>	mm	480 x 550 x 585
Internal dimensions (W x D x H)	mm	370 x 363 x 385
Volume	litres	50
Net weight	kg	45
		46

Performance		
Temperature control range and fluctuation		AT +5 °C to +50 °C <sup>2)</sup> , ±0.1 °C
Temperature uniformity <sup>3)</sup>	°C	±0.25
CO <sub>2</sub> setting range and fluctuation <sup>3)</sup>	%	0 to 20, ±0.15
O <sub>2</sub> setting range and fluctuation <sup>3)</sup>	%	— 1 to 18, 22 to 80, ±0.20
Humidity level and fluctuation	% RH	95, ±5 (Natural evaporation with humidifying pan)

Control		
Temperature sensor	Thermistor	
Sensor	CO <sub>2</sub> /O <sub>2</sub>	Dual IR / Dual IR / Stabilised Zirconia
Display	Digital (white graphic OLED) readable to 0.1 increments	

Construction		
Exterior material	Painted steel (rear cover not painted)	
Interior material	Stainless steel copper-enriched alloy	
Insulation material	Styrene Acrylonitrile copolymer	
Heating method	Direct Heat & Air Jacket System	
Outer door	qty	1 (Field reversible door)
Inner door	qty	1 (tempered glass)
Shelves	qty	2 x stainless steel copper-enriched alloy
Shelf dimensions (W x D x H)	mm	353 x 308 x 12
Max. load per shelf	kg	7
Access port	qty	1 (on the back side / Ø 30 mm)

Alarms (V = Visual Alarm, B = Buzzer Alarm, R = Remote Alarm)		
Power failure	R	
Out of temperature setting	V-B-R	
High temperature	V-B-R	
High/Low gas density	V-B-R	
Door open	V-B	

Electrical and Noise Level	MCO-50AICL		MCO-50AIC	MCO-50M		
	-PA	-PE	-PK	-PA	-PE	-PK
Power supply	V	110-120	220-240	220	110-120	220-240
Frequency	Hz	60	50/60	60	60	50/60
Noise level <sup>4)</sup>	dB [A]		29			

Options		
UV system set	MCO-170UVS-PA / MCO-170UVS-PE	
H <sub>2</sub> O <sub>2</sub> decontamination kit <sup>5)</sup>	MCO-50HB-PW	
Electric door lock with password <sup>5)</sup>	MCO-170EL-PW	
H <sub>2</sub> O <sub>2</sub> generator <sup>5)</sup>	MCO-50HP-PW (on sale soon)	
H <sub>2</sub> O <sub>2</sub> reagent	MCO-5H2O2-PV	
CO <sub>2</sub> /N <sub>2</sub> gas pressure regulator	MCO-010R-PW	
Automatic CO <sub>2</sub> cylinder changeover system	MCO-50GC-PW	
Tray	MCO-50ST-PW (same as that of standard accessory)	
Double stacking bracket	MCO-170PS-PW (allows for stacking two MCO-50 series incubators)	
Stacking plate	MCO-50SB-PW	
Roller base	MCO-50RB-PW	

Optional Communication Systems		
Ethernet interface [LAN] <sup>6)</sup>	MTR-L03-PW	
Digital interface [RS232C/RS485] <sup>6)</sup>	MTR-480-PW	
Analogue interface [4-20 mA]	MCO-420MA-PW	

Quality Management System <sup>7)</sup>	MCO-50AICL		MCO-50AIC	MCO-50M		
	-PA	-PE	-PK	-PA	-PE	-PK
Certification	ISO9001		ISO13485	ISO9001		ISO13485

- 1) External dimensions of main cabinet only, excluding handle and other external projections.
- 2) When set temperature is 37°C, ambient temperature must be 32°C or less. Regardless of ambient temperature, the maximum of temperature control range is always 50°C.
- 3) The measurement condition complies with PHCbi specified measuring method.
- 4) Nominal value background noise 20 dB(A).
- 5) MCO-50AIC(L) and MCO-50M require MCO-50HB, MCO-170EL, MCO-50HP and UV option for H<sub>2</sub>O<sub>2</sub> decontamination.
- 6) Only for the data acquisition system MTR-5000 user.
- 7) MCO-50AICL is for laboratory use.

- The optimum performance may not be obtained if the ambient temperature is not above 15°C.
- Appearance and specifications are subject to change without notice.

**Caution:** PHC Corporation guarantees this product under certain warranty conditions. However, please note that PHC Corporation shall not be responsible for any loss or damage to the contents stored in the product.

DISTRIBUTED BY:

**PHCbi**  
PHC Corporation

<https://www.phchd.com/global/biomedical/>

Printed in Japan 1307-2021-03-AA