

# Operating manual

## Recirculating Coolers

FL300

FL601

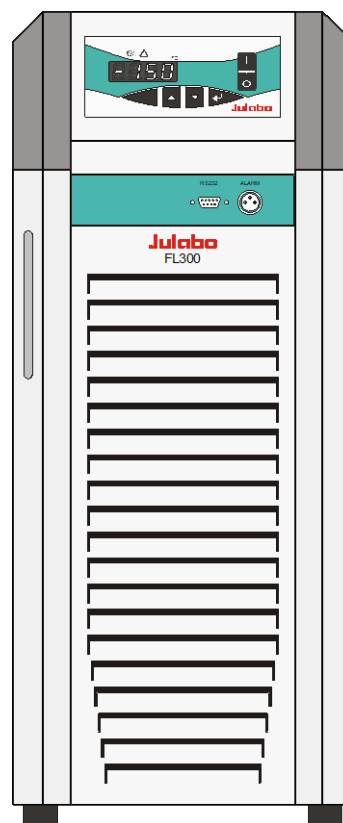

*English*

**Julabo**  
THE TEMPERATURE CONTROL COMPANY

19514818-V5.docx

04.07.19

# Congratulations!

You have made an excellent choice.

JULABO thanks you for the trust you have placed in us.

This operating manual has been designed to help you gain an understanding of the principles of operating and possibilities of our circulators. For optimum utilization of all functions, we recommend that you thoroughly study this manual prior to beginning operation.

## **The JULABO Quality Management System**



Temperature control devices for research and industry are developed, produced, and distributed according to the requirements of ISO 9001 and ISO 14001. Certificate Registration No. 01 100044846

## **Unpacking and inspecting**

Unpack the recirculating cooler and accessories and check for damages incurred during transit. These should be reported to the responsible carrier, railway, or postal authority, and a request for a damage report should be made. These instructions must be followed fully for us to guarantee our full support of your claim for protecting against loss from concealed damage. The form required for filing such a claim will be provided by the carrier.

## EC Conformity



The products described in the operating instructions conform to the requirements of the following European guidelines:

Directive of the European Parliament and of the Council on the approximation of the laws of the Member States relating to machinery.

Low voltage regulations with respect to legal harmonization of the member countries concerning electric devices for use within certain voltage limits.

EMC guideline with respect to legal harmonization of the member countries concerning electromagnetic compatibility.

RoHS directive on the restriction of the use of certain hazardous substances in electrical and electronic equipment.

**Julabo**

JULABO GmbH

Gerhard-Juchheim-Strasse 1

77960 Seelbach / Germany

EG-Konformitätserklärung nach EG Maschinenrichtlinie 2006/42/EG, Anhang II A  
EC-Declaration of Conformity to EC Machinery Directive 2006/42/EC, Annex II A

Hersteller / Manufacturer:

JULABO GmbH  
Gerhard-Juchheim-Strasse 1  
77960 Seelbach / Germany  
Tel: +49(0)7823 / 51 - 0



Hiermit erklären wir, dass das nachfolgend bezeichnete Produkt  
We hereby declare, that the following product

Produkt / Product: Umlaufkühler / Recirculating Cooler

Typ / Type: FL300

Serien-Nr. / Serial-No.: siehe Typenschild / see type label

aufgrund seiner Konzipierung und Bauart in der von uns in Verkehr gebrachten Ausführung den grundlegenden Sicherheits- und Gesundheitsanforderungen den nachfolgend aufgeführten EG-Richtlinien entspricht.  
due to the design and construction, as assembled and marketed by our Company – complies with fundamental safety and health requirements according to the following EC-Directives.

Maschinenrichtlinie 2006/42/EG; Machinery Directive 2006/42/EC  
EMV-Richtlinie 2014/30/EU; EMC-Directive 2014/30/EU  
RoHS-Richtlinie 2011/65/EU; RoHS-Directive 2011/65/EU

**Angewandte harmonisierte Normen und techn. Spezifikationen:**

The above-named product is in compliance with the following harmonized standards and technical specifications:

EN 50581 : 2012

Technische Dokumentation zur Beurteilung von Elektro- und Elektronikgeräten hinsichtlich der Beschränkung gefährlicher Stoffe  
Technical documentation for the assessment of electrical and electronic products with respect to the restriction of hazardous substances

EN ISO 12100 : 2010

Sicherheit von Maschinen - Allgemeine Gestaltungsgrundsätze - Risikoanalyse und Risikominderung (ISO 12100:2010)  
Safety of machinery - General principles for design - Risk assessment and risk reduction (ISO 12100:2010)

EN 61010-1 : 2010

Sicherheitsbestimmungen für elektrische Mess-, Steuer-, Regel- und Laborgeräte, Teil 1: Allgemeine Anforderungen  
Safety requirements for electrical equipment for measurement, control, and laboratory use, Part 1: General requirements

EN 61010-2-010 : 2014

Sicherheitsbestimmungen für elektrische Mess-, Steuer-, Regel- und Laborgeräte, Teil 2-010: Besondere Anforderungen an Laborgeräte für das Erhitzen von Stoffen  
Safety requirements for electrical equipment for measurement, control, and laboratory use, Part 2-010: Particular requirements for laboratory equipment for the heating of materials

EN 61326-1 : 2013

Elektrische Mess-, Steuer-, Regel- und Laborgeräte - EMV-Anforderungen - Teil 1: Allgemeine Anforderungen  
Electrical equipment for measurement, control, and laboratory use - EMC requirements - Part 1: General requirements

EN 378-1 : 2016

Kälteanlagen und Wärmepumpen - Sicherheitstechnische und umweltrelevante Anforderungen - Teil 1: Grundlegende Anforderungen, Begriffe, Klassifikationen und Auswahlkriterien  
Refrigerating systems and heat pumps - Safety and environmental requirements - Part 1: Basic requirements, definitions, classification and selection criteria

EN 378-2 : 2016

Kälteanlagen und Wärmepumpen - Sicherheitstechnische und umweltrelevante Anforderungen - Teil 2: Konstruktion, Herstellung, Prüfung, Kennzeichnung und Dokumentation  
Refrigerating systems and heat pumps - Safety and environmental requirements - Part 2: Design, construction, testing, marking and documentation

EN 378-3 : 2016

Kälteanlagen und Wärmepumpen - Sicherheitstechnische und umweltrelevante Anforderungen - Teil 3: Aufstellungs- und Schutz von Personen  
Refrigerating systems and heat pumps - Safety and environmental requirements - Part 3: Installation site and personal protection

EN 378-4 : 2016

Kälteanlagen und Wärmepumpen - Sicherheitstechnische und umweltrelevante Anforderungen - Teil 4: Betrieb, Instandhaltung, Instandsetzung und Rückgewinnung  
Refrigerating systems and heat pumps - Safety and environmental requirements - Part 4: Operation, maintenance, repair and recovery

**Bevollmächtigter für die Zusammenstellung der techn. Unterlagen:**

Authorized representative in charge of administering technical documentation:

Hr. Torsten Kauschke, im Hause / on the manufacturer's premises as defined above

**Die Konformitätserklärung wurde ausgestellt**

The declaration of conformity was issued and valid of

Seelbach, 17.10.2017

M. Juchheim, Geschäftsführer / Managing Director

**EG-Konformitätserklärung nach EG Maschinenrichtlinie 2006/42/EG, Anhang II A**  
**EC-Declaration of Conformity to EC Machinery Directive 2006/42/EC, Annex II A**

Hersteller / Manufacturer:

JULABO GmbH  
Gerhard-Juchheim-Strasse 1  
77960 Seelbach / Germany  
Tel: +49(0)7823 / 51 - 0



Hiermit erklären wir, dass das nachfolgend bezeichnete Produkt  
We hereby declare, that the following product

**Produkt / Product:** Umlaufkühler / Recirculating Cooler

**Typ / Type:** FL601

**Serien-Nr. / Serial-No.:** siehe Typenschild / see type label

aufgrund seiner Konzipierung und Bauart in der von uns in Verkehr gebrachten Ausführung den grundlegenden Sicherheits- und Gesundheitsanforderungen den nachfolgend aufgeführten EG-Richtlinien entspricht.  
due to the design and construction, as assembled and marketed by our Company – complies with fundamental safety and health requirements according to the following EC-Directives.

**Maschinenrichtlinie 2006/42/EG; Machinery Directive 2006/42/EC**

**EMV-Richtlinie 2014/30/EU; EMC-Directive 2014/30/EU**

**RoHS-Richtlinie 2011/65/EU; RoHS-Directive 2011/65/EU**

**Angewandte harmonisierte Normen und techn. Spezifikationen:**

*The above-named product is in compliance with the following harmonized standards and technical specifications:*

EN 50581 : 2012

Technische Dokumentation zur Beurteilung von Elektro- und Elektronikgeräten hinsichtlich der Beschränkung gefährlicher Stoffe  
Technical documentation for the assessment of electrical and electronic products with respect to the restriction of hazardous substances

EN ISO 12100 : 2010

Sicherheit von Maschinen - Allgemeine Gestaltungsgrundsätze - Risikobeurteilung und Risikominderung (ISO 12100:2010)  
Safety of machinery - General principles for design - Risk assessment and risk reduction (ISO 12100:2010)

EN 61010-1 : 2010

Sicherheitsbestimmungen für elektrische Mess-, Steuer-, Regel- und Laborgeräte, Teil 1: Allgemeine Anforderungen  
Safety requirements for electrical equipment for measurement, control, and laboratory use, Part 1: General requirements

EN 61010-2-010 : 2014

Sicherheitsbestimmungen für elektrische Mess-, Steuer-, Regel- und Laborgeräte, Teil 2-010: Besondere Anforderungen an Laborgeräte für das Erhitzen von Stoffen  
Safety requirements for electrical equipment for measurement, control, and laboratory use, Part 2-010: Particular requirements for laboratory equipment for the heating of materials

EN 61326-1 : 2013

Elektrische Mess-, Steuer-, Regel- und Laborgeräte, EMV-Anforderungen, Teil 1: Allgemeine Anforderungen  
Electrical equipment for measurement, control, and laboratory use - EMC requirements - Part 1: General requirements

EN 378-1 : 2016

Kälteanlagen und Wärmepumpen – Sicherheitstechnische und umweltrelevante Anforderungen – Teil 1: Grundlegende Anforderungen, Begriffe, Klassifikationen und Auswahlkriterien  
Refrigerating systems and heat pumps - Safety and environmental requirements - Part 1: Basics requirements, definitions, classification and selection criteria

EN 378-2 : 2016

Kälteanlagen und Wärmepumpen – Sicherheitstechnische und umweltrelevante Anforderungen – Teil 2: Konstruktion, Herstellung, Prüfung, Kennzeichnung und Dokumentation  
Refrigerating systems and heat pumps - Safety and environmental requirements - Part 2: Design, construction, testing, marking and documentation

EN 378-3 : 2016

Kälteanlagen und Wärmepumpen – Sicherheitstechnische und umweltrelevante Anforderungen – Teil 3: Aufstellungsort und Schutz von Personen  
Refrigerating systems and heat pumps - Safety and environmental requirements - Part 3: Installation site and personal protection

EN 378-4 : 2016

Kälteanlagen und Wärmepumpen – Sicherheitstechnische und umweltrelevante Anforderungen – Teil 4: Betrieb, Instandhaltung, Instandsetzung und Rückgewinnung  
Refrigerating systems and heat pumps - Safety and environmental requirements - Part 4: Operation, maintenance, repair and recovery

**Bevollmächtigter für die Zusammenstellung der techn. Unterlagen:**

*Authorized representative in charge of administering technical documentation:*

Hr. Torsten Kauschke, im Hause / on the manufacturer's premises as defined above

**Die Konformitätserklärung wurde ausgestellt**

*The declaration of conformity was issued and valid of*

Seelbach, 17.10.2017

M. Juchheim, Geschäftsführer / Managing Director

## TABLE OF CONTENTS

1. Intended use .....	8
1.1. Description .....	8
2. Operator responsibility – Safety instructions .....	8
2.1. Disposal.....	12
3. Technical specifications .....	13
4. Safety notes for the user .....	20
4.1. Explanation of safety notes .....	20
4.2. Explanation of other notes.....	20
4.3. Safety instructions .....	21
5. Installation.....	23
5.1. Tubing .....	26
6. Operating controls and functional elements .....	27
7. Operating procedures .....	29
7.1. Bath fluids.....	29
7.2. Power connection.....	30
7.3. Filling .....	31
7.4. Switching on / Start - Stop .....	32
7.5. Setting the temperatures .....	33
7.6. AUTOSTART ON / OFF .....	34
7.7. Remote control: activate – deactivate .....	35
8. Safety installations .....	36

8.1.	Excess temperature protection .....	36
8.2.	Low level protection .....	36
9.	Troubleshooting guide / Error messages .....	37
10.	Electrical connections.....	39
11.	Remote control.....	40
11.1.	Setup for remote control.....	40
11.2.	Communication with a PC or a superordinated data system.....	41
11.3.	List of commands.....	43
11.4.	Status messages.....	44
11.5.	Error messages.....	44
12.	Cleaning / repairing the unit .....	45
13.	Adequate storing of operating manual .....	47
14.	Draining.....	48
15.	Warranty conditions .....	49

## 1. Intended use

JULABO recirculating coolers have been designed for temperature application to specific fluids. The pump connections can be used for cooling applications in an external circuit at a constant temperature.



JULABO water baths are not suitable for direct temperature control of foods, semi-luxury foods and tobacco, or pharmaceutical and medical products. Direct temperature control means unprotected contact of the object with the bath medium (bath fluid).

### 1.1. Description

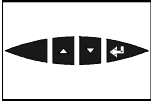

- ☑ The recirculating coolers are operated via the splash-proof keypad. The implemented microprocessor technology allows to set and to store the setpoint that can be indicated on the LED temperature display.
- ☑ The PID temperature regulation is used to withdraw heat from the bath fluid by means of the cooling machine and to automatically regulate the required need.
- ☑ Electrical connections:
  1. The serial interface RS232 allows modern process technology without additional interface.
  2. Alarm output for external alarm message.

## 2. Operator responsibility – Safety instructions

The products of JULABO ensure safe operation when installed, operated, and maintained according to common safety regulations. This section explains the potential dangers that may arise when operating the circulator and also specifies the most important safety precautions to preclude these dangers as far as possible.



The operator is responsible for the qualification of the personnel operating the units.

- The personnel operating the units should be regularly instructed about the dangers involved with their job activities as well as measures to avert these dangers.
- Make sure all persons tasked with operating, installing, and maintaining the unit have read and understand the safety information and operating instructions.
- When using hazardous materials or materials that could become hazardous, the unit may be operated only by persons who are absolutely familiar with these materials and the unit. These persons must be fully aware of possible risks.

If you have any questions concerning the operation of your unit or the information in this manual, please contact us!

**Contact** JULABO GmbH  
Gerhard-Juchheim-Strasse 1  
77960 Seelbach / Germany

Tel. +49 7823 51-0 [info.de@julabo.com](mailto:info.de@julabo.com)  
Fax +49 7823 2491 [www.julabo.com](http://www.julabo.com)

### **Safety recommendations for the operator**

- You received a product conceived for industrial use. Nevertheless, avoid strikes to the housing, vibrations, damages to the keypad foil (keys, display) or contamination.
- Make sure the product is regularly checked for proper condition. Regularly check (at least every 2 years) the proper condition of the mandatory, warning, prohibition and safety labels.
- Take care that the mains supply features a low impedance to avoid any negative affects on the instrument being operated in the same mains.
- This unit is designed for operation in a controlled electromagnetic environment. This means that transmitting devices (e.g. cellular phones) should not be used in the immediate vicinity. Magnetic radiation may influence other units with components susceptible to magnetic fields (e.g. a monitor). We recommend to keep a minimum distance of 1 m.

- Permissible ambient temperature: max. 40 °C, min. 5 °C.
- Permissible relative air humidity: 50 % (40 °C).
- Do not store in an aggressive atmosphere. Protect from contaminations.
- Do not expose to sunlight.

### **Appropriate Operation**

Only qualified personnel is authorized to perform configuration, installation, maintenance and repairs of the water bath.

Routine operation can also be carried out by untrained personnel who should however be instructed by trained personnel.



### **Use**

For the use according to the intended purpose, special material requirements have to be respected (bath fluids). Only use non-acid and non corroding materials.

Observe all warnings for the used materials (bath fluids) and the respective instructions (safety data sheets). Only use the unit in well ventilated areas. (see page 23).

The recirculating coolers are not for use in explosive atmosphere

When using hazardous materials or materials that could become hazardous, **the operator must** affix the enclosed safety labels **(1 + 2)** to the front of the unit so they are highly visible:

1		Danger area. Attention! Observe instructions. (operating manual, safety data sheet)
2		Carefully read the user information prior to beginning operation. <b>Scope: EU</b>
or		
2		Carefully read the user information prior to beginning operation. <b>Scope: USA, NAFTA</b>

Observe the instructions in the manuals for instruments of a different make that you connect to the circulator, particularly the corresponding safety instructions. Also observe the pin assignment of plugs and technical specifications of the products.

## 2.1. Disposal

This unit contains the refrigerants R134a, R404A or R452A, which at this time are not considered harmful to the ozone layer. However, over the long operating period of the unit, disposal rules may change. Therefore, only qualified personnel should handle the disposal.



Valid in EU countries

See the current official journal of the European Union – WEEE directive.

Directive of the European Parliament and of the Council on waste electrical and electronic equipment (WEEE).

This directive requires electrical and electronic equipment marked with a crossed-out trash can to be disposed of separately in an environmentally friendly manner.

Contact an authorized waste management company in your country.

Disposal with household waste (unsorted waste) or similar collections of municipal waste is not permitted!

### 3. Technical specifications

<b>Recirculating Cooler</b>		<b>FL300</b>
Working temperature range	°C	-20 ... +40
Temperature stability	°C	±0.5
Temperature selection: via key pad		digital indication on LED-DISPLAY
remote control via personal computer		indication on monitor
Temperature indication:		LED-DISPLAY
Resolution	°C	0.1
Temperature control		PID 1
Temperature sensor		Pt 100
Excess temperature protection		85 °C - fixed value
Low liquid level protection		float switch
Electrical connections:		
Computer interface		RS232
Alarm output		for external alarm signal
Circulating pump:		
discharge, max.at 0 bar	l/min	15
pressure, max. at 0 Liters	bar	0.35

Filling level indicator			sight glass
Filling volume	from ... to	Liters	3 ... 4.5
Dimensions (WxLxH)		cm	25x50x60
Weight		kg	35
Ambient temperature range		°C	5 ... 40
Return flow temperature		°C	80 max.
IP class according to IEC 60 529			IP 21
Cooling compressor			1- stage / air cooled
Refrigerant			R134a

Cooling capacity (at <b>A, B, C</b> )	°C	+20	+10	0	-10	-20
Medium: Mixture water-glycol	kW	0.3	0.25	0.2	0.15	0.1
<b>A</b> Mains power connection	V / Hz	230 ± 10 % / 50				
Current input at 230 V	A	3.0				
<b>B</b> Mains power connection	V / Hz	230 +5 % - 15 % / 60				
Current input at 230 V	A	3.0				
<b>C</b> Mains power connection	V / Hz	115 ± 10 % / 60				
Current input at 115 V	A	6.0				

Cooling capacity ( <b>D</b> at 200 V/50 Hz)	°C	<u>+20</u>	<u>+10</u>	<u>0</u>	<u>-10</u>	<u>-20</u>
Medium: Mixture water-glycol	kW	0.3	0.25	0.2	0.15	0.06
Cooling capacity ( <b>D</b> at 200 V/60 Hz)	°C	<u>+20</u>	<u>+10</u>	<u>0</u>	<u>-10</u>	<u>-20</u>
Medium: Mixture water-glycol	kW	0.3	0.25	0.2	0.15	0.09
<b>D</b> Mains power connection	V / Hz	200 ± 10 % / 50				
		200 ± 10 % / 60				
Current input at 200 V	A	3.0				

All measurements have been carried out at: rated voltage and frequency,  
ambient temperature: 20 °C

**Recirculating Cooler****FL601**

---

Working temperature range	°C	-20 ... +40
Temperature stability	°C	±0.5
Temperature selection:		digital
via key pad		indication on LED-DISPLAY
remote control via personal computer		indication on monitor
Temperature indication:		LED-DISPLAY
Resolution	°C	0.1
Temperature control		PID 1
Temperature sensor		Pt 100
Excess temperature protection		85 °C - fixed value
Low liquid level protection		float switch
Cooling capacity	°C	<u>+20</u> <u>+10</u> <u>0</u> <u>-10</u> <u>-20</u>
Medium: Mixture water-glycol	kW	0.6 0.5 0.4 0.33 0.2
Cooling compressor		1- stage / air cooled
Refrigerant		R404A, R452A*
Electrical connections:		
Computer interface		RS232
Alarm output		for external alarm signal

---

\* at 230 V / 50 Hz



Circulating pump:

discharge, max.at 0 bar	l/min	23
pressure, max. at 0 Liters	bar	1.0
		-----
Filling level indicator		sight glass
Filling volume from ... to	Liters	5.5 ... 8
Dimensions (WxLxH)	cm	32x50x60
Weight	kg	48
Ambient temperature range	°C	5 ... 40
Return flow temperature	°C	80 max.
IP class according to IEC 60 529		IP 21
Mains power connection	V / Hz	230 ± 10 % / 50
Current input at 230 V	A	5.0
Mains power connection	V / Hz	230 ± 10 % / 60
Current input at 230 V	A	5.0
Mains power connection	V / Hz	115 ± 10 % / 60
Current input at 115 V	A	10.0

---

All measurements have been carried out at: rated voltage and frequency,  
ambient temperature: 20 °C

## Warning functions and safety installations

Excess temperature protection	85 °C - fixed value
Low liquid level protection	float switch
Alarm message	optical + audible (permanent)
Excess temperature - Warning function	75 °C
Overload protection	for compressor and pump motor
Classification according to DIN 12876-1	class I

## Environmental conditions according to IEC 61 010-1:

Use only indoor.

Altitude up to 2000 m - normal zero.

Ambient temperature: +5 ... +40 °C

Air humidity:

Max. rel. humidity 80 % for temperatures up to +31 °C,

linear decrease down to 50 % relative humidity at a temperature of +40 °C

Permissible max. mains fluctuations are shown in the Technical specifications.

The unit corresponds to Class I

Overvoltage category II

Pollution degree 2



### **Caution:**

The unit is not for use in explosive environment.

Standards for interference resistance according to EN 61326-1

This unit is an ISM device classified in Group 1 (using high frequency for internal purposes) Class A (industrial and commercial range).

### **Information about the used refrigerants**

The **Regulation (EU) No. 517/2014 on fluorinated greenhouse gases** applies to all systems which contain fluorinated refrigerants and replaces (EC) 842/2006.

The aim of the Regulation is to protect the environment by reducing emissions of fluorinated greenhouse gases.

Among other things it regulates the emission limits, use and recovery of these substances. It also contains requirements for operators of systems which require / contain these substances to function.

Under Regulation 517/2014, the operator of a system of this nature has the following duties:

- The operator must ensure that the equipment is checked at regular intervals for leaks.
- These intervals depend on the CO<sub>2</sub> equivalent of the system. This is calculated from the refrigerant fill volume and type of refrigerant. The CO<sub>2</sub> equivalent of your system is shown on the model plate.
- The operator undertakes to have maintenance, repair, service, recovery and recycling work carried out by certified personnel who have been authorized by JULABO.
- All such work must be documented. The operator must keep records and archive them for at least five years. The records must be submitted to the relevant authority on request.

Refer to the text of the Regulation for further information.

## 4. Safety notes for the user

### 4.1. Explanation of safety notes



In addition to the safety warnings listed above, warnings are posted throughout the manual. These warnings are designated by an exclamation mark inside an equilateral triangle. "Warning of a dangerous situation (Attention! Please follow the documentation)."

The danger is classified using a signal word.

Read and follow these important instructions.



**Warning:**

Describes a possibly highly dangerous situation. If these instructions are not followed, serious injury and danger to life could result.



**Caution:**

Describes a possibly dangerous situation. If this is not avoided, slight or minor injuries could result. A warning of possible property damage may also be contained in the text.



**Notice:**

Describes a possibly harmful situation. If this is not avoided, the product or anything in its surroundings can be damaged.

### 4.2. Explanation of other notes



**Note!**

Draws attention to something special.



**Important!**

Indicates usage tips and other useful information.

### 4.3. Safety instructions

Follow the safety recommendations to prevent damage to persons or property. Further, the valid safety instructions for working places must be followed.



- Only connect the unit to a power socket with earthing contact (PE – protective earth)!
- The power supply plug serves as a safe disconnecting device from the line and must always be easily accessible.
- Place the instrument on an even surface on a pad made of non-inflammable material.
- Do not stay in the area below the unit.
- Make sure you read and understand all instructions and safety precautions listed in this manual before installing or operating your unit.
- Never operate the unit without bath fluid in the bath.
- Do not drain the bath fluid while it is hot or cold!  
Check the temperature of the bath fluid prior to draining (by switching the unit on for a short moment for example).
- Use suitable connecting tubing.
- Make sure that the tubing is securely attached.
- Avoid sharp bends in the tubing, and maintain a sufficient distance from surrounding walls.
- Regularly check the tubing for material defects (e.g., for cracks).
- Never operate damaged or leaking equipment.
- Always turn off the unit and disconnect the mains cable from the power source before performing any service or maintenance procedures, or before moving the unit.

- Always turn off the unit and disconnect the mains cable from the power source before cleaning the unit.
- Always empty the bath before moving the unit.
- Transport the unit with care.
- Sudden jolts or drops may cause damage in the interior of the unit.
- Observe all warning labels.
- Never remove warning labels.
- Never operate equipment with damaged mains power cables.
- Repairs are to be carried out only by qualified service personnel.



- Risk of injury for hands. Close cover carefully.



- Some parts of the bath tank and the pump connections may become extremely cold during continuous operation. Therefore, exercise particular caution when touching these parts.

## 5. Installation

- Place the unit on an even surface on a base made of **nonflammable** material.
- Cooling machine, pump motor and electronics produce intrinsic heat that is dissipated via the venting openings ! Never cover these openings!
- Keep at least 20 cm of open space on the front and rear venting grids.
- The place of installation should be large enough and provide sufficient air ventilation to ensure the room does not warm up excessively because of the heat the instrument rejects to the environment.

For a fault (leakage) in the refrigeration system, the standard EN 378 prescribes a certain room space to be available for each kg of refrigerant.

The necessary amount of refrigerant is specified on the type plate.

> For 0.25 kg of refrigerant R134a, 1 m<sup>3</sup> of space is required.

> For 0.52 kg of refrigerant R404A, 1 m<sup>3</sup> of space is required.

> For 0.423 kg of refrigerant R452A, 1 m<sup>3</sup> of space is required.

-

Example: FL300 ↓

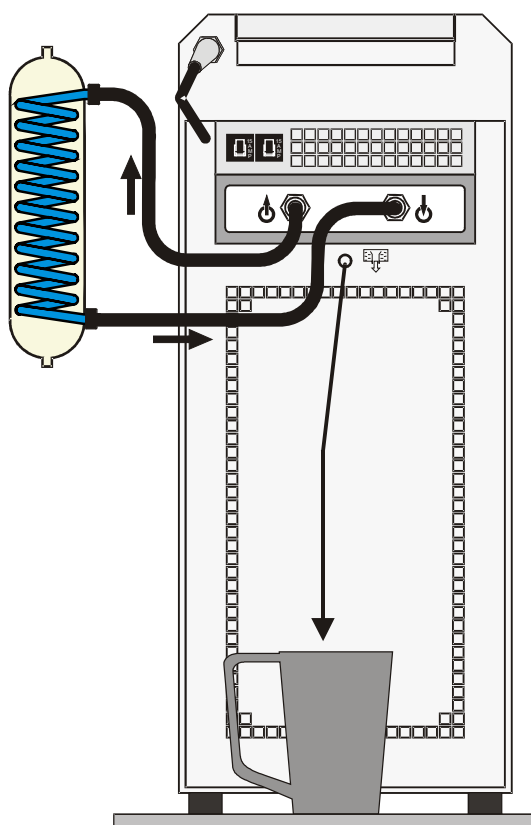

- Connect the tubings for cooling the external system to the pump connectors M16x1 for feed and return (12) on the rear of the recirculating cooler.

↑ - Feed    ↓ - Return

- Connect a piece of tubing to the overflow connector (13) and drain into a suitable vessel, which always has to be placed lower than the exit „Overflow“.
- Do not set up the unit in the immediate vicinity of heat sources and do not expose to sun light.
- Before operating the unit after transport, **wait about one hour after setting it up**. This will allow any oil that has accumulated laterally during transport to flow back down thus ensuring maximum cooling performance of the compressor.



**Caution:**

Securely attach all tubing to prevent slipping.





**Notice: Flood hazard!**

In case the system to be cooled is located at a higher level than the recirculating cooler, take note of bath liquid flowing back when the unit is switched off.

**Return flow safety device**

Should the filling volume of the bath tank not be sufficient, prevent the liquid from flowing back by using shut-off valves..

<b>Order No.</b>	<b>Description</b>	<b>Suitable for</b>
8 970 456	Shut-off valve for loop circuit, M16x1	FL300 / FL601

The following questions shall help to recognize possible dangers and to reduce the risks to a minimum.

- Are all tubes and electrical cables connected and installed?  
Note:  
sharp edges, hot surfaces in operation, moving machine parts, etc.
- What to do when a dangerous substance was spilled on or in the unit?  
Before starting to work, obtain information concerning the substance and determine the method of decontamination.

## 5.1. Tubing



### Caution:

- Employ suitable connecting tubing.
- Make sure that the tubing is securely attached.
- Avoid sharp bends in the tubing, and maintain a sufficient distance from surrounding walls.
- Regularly check the tubing for material defects (e.g. for cracks).
- Preventive maintenance: Replace the tubing from time to time.

### Recommended tubing:

Order No.		Suitable for
8930008	1 m CR <sup>®</sup> -tubing 8 mm inner dia. (-20 ... +120 °C)	FL300
8930308	1 m Reinforced tubing 8 mm inner dia. (-40 ... +120 °C)	FL601
8930312	1 m Reinforced tubing 12 mm inner dia. (-40 ... +120 °C)	FL601

### Tubing insulation

8930410	1 m Insulation, 14 mm inner dia..	CR <sup>®</sup> -tubing 8 mm inner dia
8930412	1 m Insulation, 18 mm inner dia.	Reinforced tubing 8 mm inner dia.
8930413	1 m Insulation, 23 mm inner dia.	Reinforced tubing 12 mm inner dia.

### Tube clamps

8970480	2 Tube clamps, size 1	CR <sup>®</sup> -tubing 8 mm inner dia
8970481	2 Tube clamps, size 2	Reinforced tubing 8 mm inner dia.
8970482	2 Tube clamps, size 3	Reinforced tubing 12 mm inner dia.

## 6. Operating controls and functional elements

Example: FL300 Front view

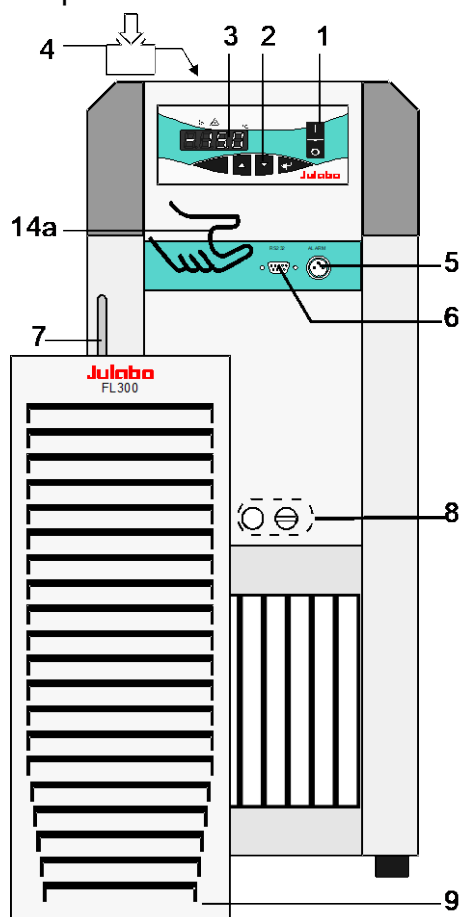



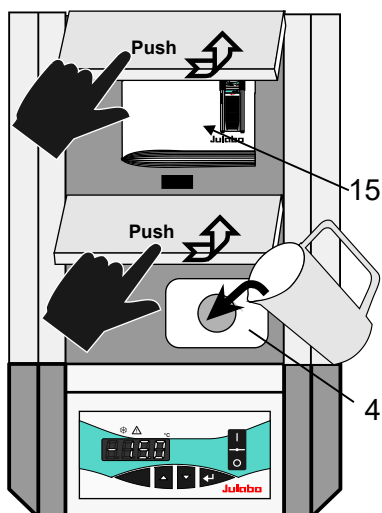





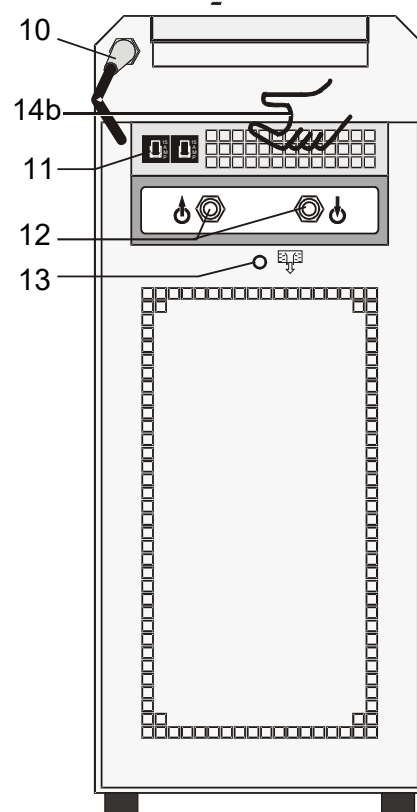

Top view

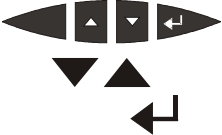

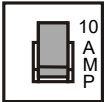

- 4 Protection lid for fill in opening
- 15 Protection lid for storing place of operating manual

Rear view



- 1  Mains power switch, splash-water protected  
  - | on
  - off
- 2.0  **Keypad**, splash-water protected
- 2.1 Edit keys (set point increase or decrease)
- 2.2 Enter key Store set point value / parameter
- 3.0 **Indication**
- 3.1  LED temperature display
- 3.2  Control indicator – Cooling
- 3.3  Control indicator – Alarm
- 4.0 Filling opening
- 5  Alarm output (for external alarm signal)
- 6  Interface RS232: remote control via personal computer
- 7 Filling level indication
- 8 Drain port
- 9 Venting grid, removable
- 10 Mains power cable with plug
- 11  Mains circuit breakers (resettable)
- 12 Pump connector M16x1:  - Feed  
Pump connector M16x1:  - Return

13		Overflow connector
14a		Handle: front
14b		Handle: rear
15		Protection lid for storing place of operating manual

## 7. Operating procedures

### 7.1. Bath fluids



#### **Caution:**

No liability for use of other bath liquids!

Please contact JULABO before using other than recommended bath fluids. JULABO takes no responsibility for damages caused by the selection of an unsuitable bath fluid

**Do not use alcohols.**

#### **Water:**

The quality of water depends on local conditions.

- Due to the high concentration of lime, hard water is not suitable for temperature control because it leads to calcification in the bath.
- Ferrous water can cause corrosion - even on stainless steel.
- Chloric water can cause pitting corrosion.
- Distilled and deionized water is unsuitable. Their special properties cause corrosion in the bath, even in stainless steel.

**Water:** - No liability for use with water.

Danger of freezing at working temperatures <5 °C.

## Recommended bath fluids:

Bath fluids	Temperature range
soft/decalcified water	5 °C to 80 °C



See website for list of recommended bath fluids.

**Contact:** [www.julabo.com](http://www.julabo.com)

## 7.2. Power connection



### **Caution:**

- Only connect the unit to a power socket with earthing contact (PE – protective earth)!  
We disclaim all liability for damage caused by incorrect line voltages!
- The power supply plug serves as safe disconnecting device from the line and must be always easily accessible.
- Never operate equipment with damaged mains power cables.
- Regularly check the mains power cables for material defects (e.g. for cracks).

Make sure that the line voltage and frequency match the supply voltage specified on the type plate.

### 7.3. Filling

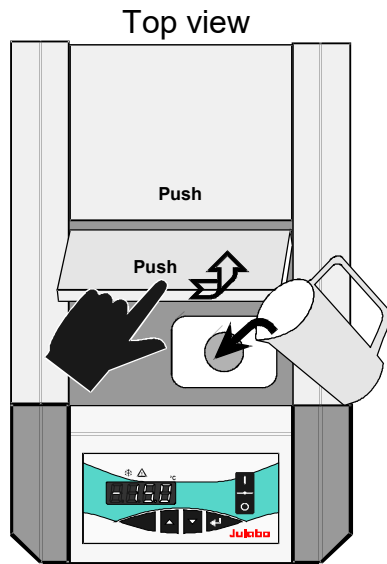

Filling level indicator (13)

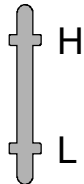

Take care that no liquid enters the interior of the circulating cooler.

- ① Connect the tubing from the external system to the pump connectors and check for leaks



Respect instructions from page 23 to page 26!

- ① Check to make sure that the drain tap (8) is closed.

- Unlock and open lid of fill in opening (4) by slightly pushing.
- Fill in tempering fluid up to marking „H“ of the filling level indicator.
- Turn the mains switch (1) on (Switching on - see page 32).
- Switch on unit. To do so press button  for approx. 4 seconds.
- Tempering fluid is pumped into the externally connected system.  
Refill fluid up to marking „H“.
- The recirculating cooler is ready for operation.

## 7.4. Switching on / Start - Stop

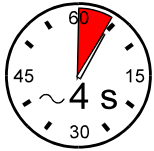
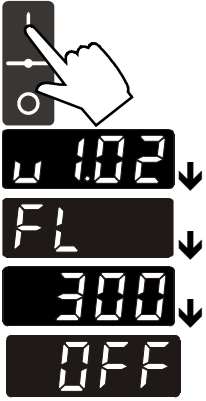

### Switching on:

The recirculating cooler is turned on and off with the mains switch.

The unit performs a self-test. All segments of the 4-digit LED temperature DISPLAY and all indicator lights will illuminate (as illustrated on the left).

Then the software version and the type of unit is indicated.

Examples: (v 1.02) (FL300)

The display "OFF" indicates the unit is ready to operate (standby mode).

**Start:** Press enter  for about 4 seconds.

The LED temperature DISPLAY indicates the actual bath temperature.

**Stop:** Press enter  for about 4 seconds.

Turn the unit off with the mains power switch.



## 7.5. Setting the temperatures

Factory setting:  
25 °C

① Setting can be carried out in the start/stop condition.

1. Press one of the keys ▼ ▲ for a short moment.  
The setpoint value instead of the actual value is indicated on the display for about 8 seconds.  
The value can now be changed.
2. Change value:  
Press ▲ to set a higher value.  
Press ▼ to set a lower value.  
Keep the keys depressed for the value to change fast.
3. Press enter ↵ to store the value.

## 7.6. AUTOSTART ON / OFF

The recirculating cooler has been configured and supplied by JULABO according to N.A.M.U.R. recommendations. This means for the start mode, that the unit must enter a safe operating state after a power failure (non-automatic start mode). This safe operating state is indicated by „OFF“ on the LED temperature display. A complete shutdown of the main functional elements such as compressor and circulating pump is effected simultaneously.

Should such a safety standard not be required, the AUTOSTART function (automatic start mode) may be activated, thus allowing the start of the circulator directly by pressing the mains power switch or using a timer.

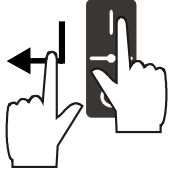

Keep depressed enter  and turn on the unit with the mains power switch.

For a short while the LED DISPLAY indicates the effective start mode:

 ⇒ AUTOSTART on.

 ⇒ AUTOSTART off.



### **Warning:**

For supervised or unsupervised operation with the AUTOSTART function, avoid any hazardous situation to persons or property.

The circulator does no longer conform to N.A.M.U.R. recommendations.

## 7.7. Remote control: activate – deactivate

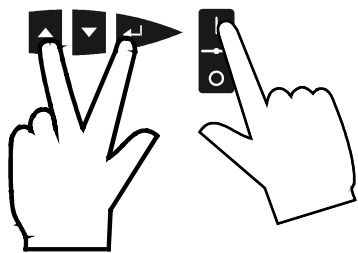

(Interface OFF)

10FF

(Interface On)

10n ↓

0.102 ↓

FL ↓

300 ↓

rOFF

The recirculating cooler is to be prepared for remote control by a personal computer via the serial interface RS232.

Set the interface item from >IOFF< to >ION<.

### Remote control: activate – deactivate:

- Switch off recirculating cooler by pressing the mains switch and wait approx. 5 seconds.
- Keep depressed the keys ▲ and enter ↵ simultaneously and turn on the unit with the mains power switch.

>I OFF< No remote control via RS232 (Factory setting)

>I On< Remote control via RS232

- ① The software version and the type of unit is indicated (see example on the left).

The display "rOFF" indicates the unit is ready to be operated via remote control.

## 8. Safety installations

### 8.1. Excess temperature protection

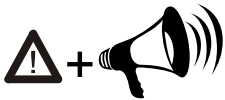

This safety installation is independent of the control circuit.

When the temperature of the bath fluid has reached the safety temperature (85 °C), a complete shutdown of the compressor and pump is effected.

The alarm is indicated by optical and audible signals (continuous tone) and on the LED-DISPLAY appears the error message "Error 14".

### 8.2. Low level protection



This safety installation is independent of the control circuit.

If the low liquid level protection device is triggered, a complete shutdown of the compressor and circulating pump is effected.

The alarm is indicated by optical and audible signals (continuous tone) and on the LED-DISPLAY appears the error message "Error 01".

- ⓘ Turn off the unit with the mains switch, refill bath fluid and turn the unit on again!



#### **Caution:**

For refill always use the same bath fluid type that is already in the bath.

**Notice:**

Check the low liquid level protection device at least twice a year!

- To execute a functional test, drain the liquid until the alarm for low liquid level is triggered. Refill liquid afterwards.

## 9. Troubleshooting guide / Error messages



Whenever the microprocessor electronics registers a failure, a complete shutdown of the compressor and circulating pump is performed. The alarm light "▲" illuminates and a continuous signal tone sounds. The LED temperature display indicates the cause for the alarm in form of a code.



Press enter  to quit the audible signal.



- The recirculating cooler is operated without bath fluid, or the liquid level is insufficient.  
Replenish the bath tank with the bath fluid.
- Tube breakage has occurred (insufficient filling level due to excessive bath fluid pumped out). Replace the tubing and replenish the bath tank with the bath fluid.



Cable of the working temperature sensor interrupted or short-circuited.



Error in A/D converter



The return temperature is above the switch-off value of the high temperature protection (85°C). Check dimensioning of application.  
Use a stronger recirculating cooler if necessary.

---



After eliminating the malfunction, press the mains power switch off and on again to cancel the alarm state.

If the unit cannot be returned to operation, contact an authorized service station.

---



**Warning without a complete shutdown of the unit**

Excess temperature warning starting at 75 °C

The return temperature soon reaches the switch-off value of the high temperature protection (85 °C).

---

If the unit cannot be returned to operation, contact an authorized JULABO service station.

**Disturbances that are not indicated.**

Overload protection: a) for cooling machine  
b) for pump motor

After a short cooling interval, the unit will automatically start running.

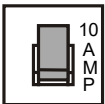

Mains circuit breakers (resettable) –10A.

## 10. Electrical connections



**Notice:** Use shielded cables only.

The shield of the connecting cable is electrically connected to the plug housing.

**Use a null modem cable.**

The unit ensures safe operation if connecting cables with a maximum length of 3 m are used. The use of longer cables does not affect proper performance of the unit, however external interferences may have a negative impact on safe operation.

### RS232 serial interface

This port can be used to connect a computer with an RS232 cable for remote control of the recirculating cooler.

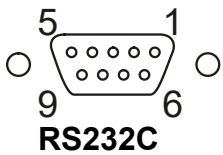

**Pin assignments:**

Pin 2	RxD	Receive Data
Pin 3	TxD	Transmit Data
Pin 5	0 V	Signal GND
Pin 7	RTS	Request to send
Pin 8	CTS	Clear to send

Pin 1; 4; 6, 9 Reserved - do not use!

**Accessories:**

Order No.	Description
8 980 073	RS232 interface cable 9-pol./9-pol. , 2,5 m
8 900 110	USB interface adapter cable

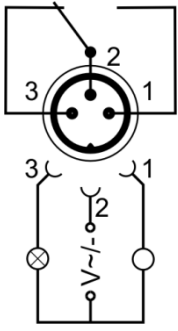

## Alarm output

Potential-free change-over contact for external alarm signal.

Pin 2 and 3 are connected in case of an alarm.

Pin 2 and 1 are connected in normal condition or mains switch "Off".

**-150 OFF -OFF** or **0000**

Switching capacity max. 30 W / 30 VA

Switching voltage max. 30 V~/–

Switching current max. 1 A

## 11. Remote control

### 11.1. Setup for remote control

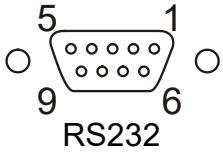

Check the interface parameters for both interfaces (on recirculating cooler and PC) and make sure they match.

**Interface parameters are pre-determined.**

<b>Type</b>	RS232
<b>Baudrate</b>	4800 bauds
<b>Parity</b>	even
<b>Handshake</b>	hardware handshake
<b>Data bits</b>	7
<b>Stop bit</b>	1



## 11.2. Communication with a PC or a superordinated data system

If the recirculating cooler is put into remote control mode the MULTI-DISPLAY (LED) will read „R -OFF-„ = REMOTE STOP. The recirculating cooler is now operated via the computer.

In general, the computer (master) sends commands to the recirculating cooler (slave). The recirculating cooler sends data (including error messages) only when the computer sends a query.



In remote control mode:

After a power interruption the order to start and all values which have to be adjusted must be resent from the personal computer via the interface.

AUTOSTART is not possible.

A transfer sequence consists of:

- command out/in command
- space (↔; Hex: 20) out/in command
- parameter (the character separating decimals in a group is the period) out command
- end of file (↵; Hex: 0D) out/in command
- The response (data string) after an **in** command is always followed by a line feed (LF, Hex: 0A).



### Important times for a command transmission:

To ensure a safe data transfer, the time gap between two commands should be at least 250 ms.

The recirculating cooler automatically responds to an **in** command with a data string followed by a LF (Line Feed). The next command should only be sent after 10 ms.

The commands are divided into **in** or **out** commands.

**in** commands: asking for parameters to be displayed

**out** commands: setting parameters



The **out** commands are valid only in remote control mode.

Examples:

Command to set the working temperature to 15,5 °C:

**out\_sp\_00 ↔ 15.5↵**

Command to ask for the working temperature

**in\_sp\_00↵**

Response from the recirculating cooler:

**15.5↵ LF**

### 11.3. List of commands

**out commands:** Setting parameters or temperature values.

Command	Parameter	Response of recirculating cooler
out_mode_05	0	Stop the unit = R –OFF-.
out_mode_05	1	Start the unit.
out_sp_00	xxx.xx	Set working temperature

**in commands:** Asking for parameters or temperature values to be displayed.

Command	Parameter	Response of recirculating cooler
version	none	Number of software version (V X.xx)
status	none	Status message, error message (see page 44 )
in_pv_00	none	Actual bath temperature.
in_sp_00	none	Working temperature
in_mode_05	none	Recirculating cooler in Stop/Start condition: 0 = Stop 1 = Start

## 11.4. Status messages

Status messages	Description
00 MANUAL STOP	Recirculating cooler in „OFF“ state.
01 MANUAL START	Recirculating cooler in keypad control mode.
02 REMOTE STOP	Recirculating cooler in „r OFF“ state.
03 REMOTE START	Recirculating cooler in remote control mode.

## 11.5. Error messages

Error messages	Description
-01 LOW LEVEL ALARM	Low liquid level alarm.
-05 WORKING SENSOR ALARM	Working temperature sensor short-circuited or interrupted.
-03 EXCESS TEMPERATURE WARNING	High temperature warning. Starting at 75 °C (no deactivation) The return temperature soon reaches the switch-off value of the high temperature warning function (85 °C)
-07 I <sup>2</sup> C-BUS ERROR	Internal error when reading or writing the I <sup>2</sup> C bus.
-08 INVALID COMMAND	Invalid command.
-09 COMMAND NOT ALLOWED IN CURRENT OPERATING MODE	Invalid command in current operating mode.
-10 VALUE TOO SMALL	Entered value too small.

Error messages	Description
-11 VALUE TOO LARGE	Entered value too large.
-12 TEMPERATURE MEASUREMENT ALARM	Error in A/D converter.
-14 EXCESS TEMPERATURE PROTECTOR ALARM	The return temperature is above the switch-off value of the high temperature warning function of 85 °C. Check dimensioning of application. Use a stronger recirculating cooler if necessary.

## 12. Cleaning / repairing the unit



### **Caution:**

Always turn off the unit and disconnect the mains cable from the power source before cleaning the unit.

Prevent humidity from entering into the circulator.

Electrical connections and any other work must be performed by qualified personnel only.



### **Notice:**

Risk of injury for hands when mounting the venting grid.

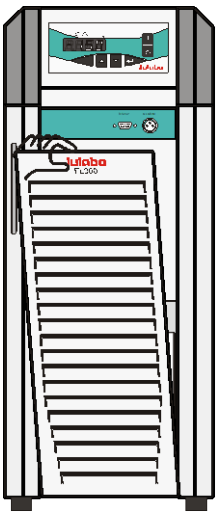

To maintain the full cooling performance, clean the condenser from time to time.

- Switch off the unit, disconnect mains power cable.
- Hold the venting grid, pull out and remove.
- Clean the ribbed condenser with a vacuum cleaner.
- Replace the venting grid.
- Switch on the unit.

### **Cleaning:**

Clean the outside of the unit using a wet cloth and low surface tension water. The recirculating cooler is designed for continuous operation under normal conditions. Periodic maintenance is not required.

The tank should be filled only with a bath fluid recommended by JULABO. To avoid contamination, it is essential to change the bath fluid from time to time.

### **Repairs:**

Before asking for a service technician or returning a JULABO instrument for repair, please contact an authorized JULABO service station.

When returning the unit:

- Clean the unit in order to avoid any harm to the service personnel
- Attach a short fault description.
- When returning a unit, take care of careful and adequate packing.
- JULABO is not responsible for damages that might occur from insufficient packing.



JULABO reserves the right to carry out technical modifications with repairs for providing improved performance of a unit.

### **13. Adequate storing of operating manual**

Store the operating manual at the foreseen place at the unit and lock it by means of the protection lid (15).

## 14. Draining



### Notice:

Store and dispose the used bath fluid according to the laws for environmental protection.



Risk of injury for hands when mounting the venting grid.

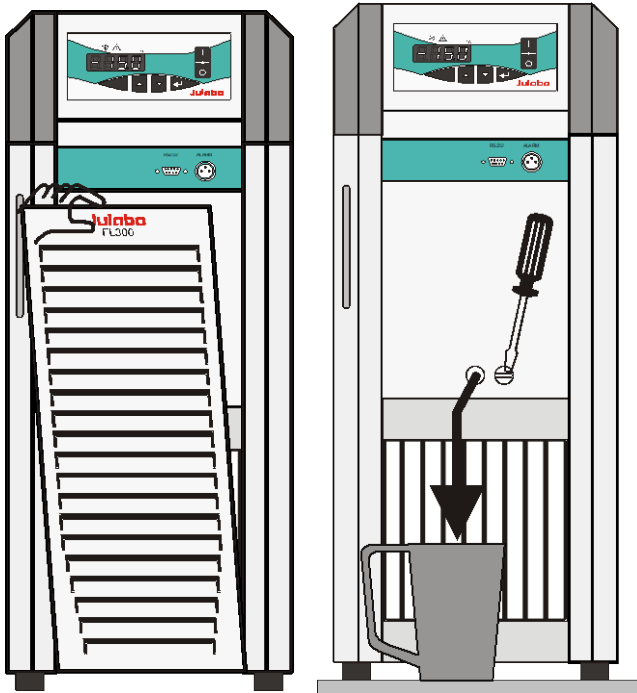

- Turn off the unit and disconnect the mains cable from the power source.
- Hold the venting grid, pull out and remove.
- Slide a short piece of tube onto the drain connection (8) and hold it into a container.
- Loosen the drain screw a few turns and drain the unit completely.
- Close the drain tap and replace the venting grid.



## 15. Warranty conditions

JULABO GmbH warrants its products against defects in material or in workmanship, when used under appropriate conditions and in accordance with appropriate operating instructions  
**for a period of ONE YEAR.**

**Extension of the warranty period – free of charge**



With the '1PLUS warranty' the user receives a free of charge extension to the warranty of up to 24 months, limited to a maximum of 10 000 working hours.

To apply for this extended warranty the user must register the unit on the JULABO web site [www.julabo.com](http://www.julabo.com), indicating the serial no. The extended warranty will apply from the date of JULABO GmbH's original invoice.

JULABO GmbH reserves the right to decide the validity of any warranty claim. In case of faults arising either due to faulty materials or workmanship, parts will be repaired or replaced free of charge, or a new replacement unit will be supplied.

Any other compensation claims are excluded from this guarantee.



JULABO GmbH  
77960 Seelbach / Germany

Tel. +49 (0) 7823 / 51-0  
Fax +49 (0) 7823 / 24 91

[info.de@julabo.com](mailto:info.de@julabo.com)  
[www.julabo.com](http://www.julabo.com)

Changes without prior notification reserved Printed in Germany

1.951.4818-V5 08/17

**Important:** keep original operating manual for future use