



NÜVE SANAYİ MALZEMELERİ İMALAT VE TİCARET A.Ş.

DF 290 / DF 490 / DF 590

DirectFREEZE™

**ULTRA LOW TEMPERATURE
DEEP FREEZER**

INSTRUCTION MANUAL



Dear Nüve User,

We would like to take this opportunity to thank you for preferring this Nüve product. Please read the operating instructions carefully and keep them handy for future reference.

Please detain the packing material until you see that the unit is in good condition and it is operating properly. If an external or internal damage is observed, contact the transportation company immediately and report the damage. According to ICC regulations, this responsibility belongs to the customer.

While you are operating the instrument please;

1. obey all warning labels,
2. do not remove warning labels,
3. do not operate damaged instrument,
4. do not operate instrument with a damaged cable,
5. do not move instrument during operation.

In case of a problem contact your Nüve agent for an authorized service or maintenance.

The validity of the guarantee is subject to compliance with the instructions and precautions described in this manual.

Nüve reserves the right to improve or change the design of its products without any obligation to modify previously manufactured products.

Information contained in this document is the property of Nüve. It may not be duplicated or distributed without our permission.

NÜVE
SANAYİ MALZEMELERİ
İMALAT VE TİCARET A.Ş.

Saracalar Mahallesi, Saracalar Kümeevleri No:4/2
Akyurt 06750 Ankara / TURKEY
Tel : (90.312) 399 28 30 (pbx)
Fax : (90.312) 399 21 97
Sales : sales@nuve.com.tr
Technical Service: nuveservice@nuve.com.tr

WARRANTY CERTIFICATE

1. Nüve warrants that the equipment delivered is free from defects in material and workmanship. This warranty is given for a period of two years. The warranty period begins from the delivery date.
2. Warranty does not apply to parts normally consumed during operation or general maintenance or any adjustments described in the operating instructions provided with the instrument.
3. Nüve does not accept any liability in case where the goods are not used in accordance with their proper intent.
4. The warranty may not be claimed for damages incurred during the shipment, for damages resulting from improper handling or use, abuse, fire, liquid spillage, tampering or unauthorized repairs by any persons, use of defective or incompatible accessories, exposure to abnormally corrosive conditions, use of the product in non-standard environmental conditions, including but not limited to failure to meet requirements of ambient temperature, lubrication, humidity or magnetic field influences, from the defects in maintenance, negligence, bad functioning of auxiliary equipment, in the case of force majeure or accident and incorrect power supply.
5. Any injury, loss or damage caused; due to a failure resulting from negligence of the instructions given in this manual; is beyond the scope of the warranty conditions.



BEFORE OPERATING THE INSTRUMENT THIS MANUAL SHOULD BE READ CAREFULLY.



THE VALIDITY OF THE GUARANTEE IS SUBJECT TO THE OBSERVATION OF THE INSTRUCTIONS AND PRECAUTIONS DESCRIBED IN THIS MANUAL.

INFORMATION CONTAINED IN THIS DOCUMENT IS THE PROPERTY OF NÜVE. IT MAY NOT BE DUPLICATED OR DISTRIBUTED WITHOUT PERMISSION.

PLEASE REGISTER ONLINE TO VALIDATE YOUR WARRANTY:

To register your warranty online, please visit our webpage www.nuve.com.tr and fill in the “Warranty Registration Form”.

CONTENT

	Page
1. INTRODUCTION	5
1.1. USE AND FUNCTION	5
2. TECHNICAL SPECIFICATIONS	6
2.1. TECHNICAL SPECIFICATIONS TABLE	6
2.2. ACCESSORIES	7
2.2.1. FACTORY FITTED ACCESSORIES	7
2.2.2. OPTIONAL ACCESSORIES	7
3. PRECAUTIONS AND LIMITATIONS ON USE	7
4. SYMBOLS AND LABELS	8
5. INSTALLATION	9
5.1. ENVIRONMENTAL CONDITIONS	9
5.2. HANDLING AND TRANSPORTATION	10
5.3. UNPACKING	10
5.4. MAINS SUPPLY	10
5.5. POSITIONING	10
5.6. GENERAL PRESENTATION	11
5.6.1. CHAMBER DIMENSIONS	12
5.7. CONTROL PANEL	12
5.8. PRIOR TO OPERATION	14
6. OPERATING PRINCIPLES	14
6.1. PROGRAMMING	14
6.1.1. OPERATING MODE	14
6.1.2. SETTINGS	15
6.1.3. MEMORY	16
6.1.3.1. INTERNAL MEMORY	17
6.1.3.2. EXTERNAL MEMORY (USB STICK)	18
6.1.4. SMS	19
6.1.5. E-MAIL	20
6.1.6. SET TEMPERATURE	21
6.1.7. GRAPH WORKING SCREEN	21
6.1.8. TEMPERATURE ALARM RANGE	21
7. PERIODIC MAINTENANCE AND CLEANING	22
7.1. PERIODIC MAINTENANCE	22
7.2. CLEANING	22
8. DISPOSAL MANAGEMENT CONCEPT	23
9. TROUBLESHOOTING	23
9.1. ERROR CODES	23
9.2. FUSE REPLACEMENT	24
10. OPTIONS	24
10.1. AlerText™ GSM MODULE	24
10.2. NüveWARN™ REMOTE ALARM SYSTEM	25
10.2.1. MOUNTING REMOTE ALARM	25
10.3. CHART RECORDER	26
10.4. CO ₂ BACK-UP UNIT	26
11. ELECTRICAL CIRCUIT DIAGRAM	28
11.1. DF 290, DF 490 AND DF 590 ELECTRICAL CIRCUIT DIAGRAM	28

I. INTRODUCTION

I.1. USE AND FUNCTION

DF series Ultra Low Temperature Freezer is designed for the storage of the samples needed to store at ultra-low temperature and it is used in the hospitals, blood banks, epidemic diseases research centers, research laboratories in the universities, genetic engineering and bio-pharmaceutical industry.

DF Series Ultra Low Temperature Freezers are capable of cooling down to set points between -45°C and -90°C with 1°C sensitivity and keep temperature stable within given tolerances. The live of the most of the biological samples stop at -70°C. These samples can be stored for a long time without loss of their vital functions by using Ultra-low temperature freezers. DF series protect living cells and tissues for a long time without any destruction.

The refrigerant gas passes through evaporators placed under each shelf, bottom of the chamber and top of the chamber; thus, each compartment of freezer is cooled directly. DF series provides a stronger and more rapid cooling with its **DirectFREEZE™** technology. Refrigeration system is cascade system in DF series. The refrigeration is provided by non-explosive refrigerant gas which does not include CFC.

The power switch is equipped with a key lock to prevent unauthorized usage. Door handle on DF series can be opened easily. Moreover, silicon gasket placed on the door protects air leakage.

DF series Ultra-Low Temperature Freezer has audible and visual alarm systems for the following cases; high and low temperature conditions, power failure, temperature sensor failure and other faults related with the microprocessor control system. DF series store last 50 failures in the memory and these errors can be followed on the display. Standard Ethernet connection feature enables email sending to five different e-mail addresses in case of any error. DF series offer **AlerText™** GSM module as an option and SMS can be sent to five different mobile phone numbers in case of error.

The display is fed by an automatically re-chargeable battery in case of power failure. Therefore, temperature in the chamber is displayed in case of electricity interruption. Remote alarm outlet and the outlet for connection to central alarm system are offered as standard.

DF series ultra-low temperature freezers have internal memory which can store temperature values for 10 years. In addition to internal memory, temperature values can be recorded in USB stick. DF series have a weekly circular chart recorder as an option. The temperature in the chamber is recorded by this chart recorder operated by the backup battery. Chart recorder is equipped with a key lock to prevent unauthorized usage.

CO₂ back-up system is an optional accessory. This system provides to keep temperature stable at -60°C in case of power failure or compressor failure. Thus, samples in the chamber are protected against temperature increase.

DF Series Freezers are designed and manufactured in accordance with national and international directives, EN 50419 and EN 61000-6-3 standards under the supervision of total quality management systems ISO 9001 and ISO 13485.

This device is in compliance with WEEE Regulation.

If the warnings mentioned in this manual are not considered, NUVE will not be responsible from their results.

2. TECHNICAL SPECIFICATIONS

2.1. TECHNICAL SPECIFICATIONS TABLE

TECHNICAL SPECIFICATIONS	DF 290	DF 490	DF 590
Freezing System	DirectFREEZE™		
Temperature Sensor	Pt-100		
Temperature Set and Reading Sensitivity	1°C		
Temperature Set Range	-45°C to -90°C		
Temperature Variation (on samples)	< 2.0°C	< 3.0°C	
Chamber Volume (Liter)	261	461	560
Refrigerants	R507 - R508B		
Remote Alarm and Alarm Back-up	12-hours with automatically recharged battery		
Alarm System	Audible and Visual		
Temperature Alarm Range	Set point +5°C to +25°C		
Safety System	Pressure Switch (Automatic reset), Pressure Switch (Manual reset)		
Insulation	130 mm injected polyurethane block (CFC-free)		
Chamber Configuration (independent compartment / internal insulation door)	3 / 3	4 / 4	
Control System	N-SmArt™ Microprocessor		
Temperature Indicator	Colorful LCD		
Temperature Recorder (Optional)	Battery operated 7-day chart with key lock		
Internal Memory	10-year memory, one record per hour		
USB	Standard		
Ethernet	Standard		
RS 232 / GSM	Standard		
Central Alarm Outlet	Standard		
CO ₂ Back-up system	Liquid CO ₂		
Power Supply	230 V, 50 Hz		
Power Consumption (Watt)	1600		
Internal Material	Stainless steel		
External Material	Epoxy-polyester powder coated stainless steel		
Internal Dimensions (WxDxH) mm	420x625x995	555x630x1320	555x770x1320
External Dimensions (WxDxH) mm	680x1070x1715	820x965x2035	815x1120x2010

2.2. ACCESSORIES

2.2.1. FACTORY FITTED ACCESSORIES

DF XXX Y Weekly temperature chart recorder 0°C / -100°C

2.2.2. OPTIONAL ACCESSORIES

A 08 191	AlerText™ GSM alarm module
K 13 009	NuveWarn™ Remote alarm system with 10 m cable
A 08 195	NuveCloser™ Software CD with 3 m.RS 232 cable
A 08 135	CO ₂ back-up unit
A 08 137	Rack for 135 x 135 x 50 mm PP cryoboxes (DF 290 and DF 490)
A 08 138	PP Cryobox 52 x 133 x 133mm capacity 9 x 9 tubes
A 08 150	Rack with three drawers (DF 290 and DF 490)
A 08 151	Rack for 135x135x75 mm cryoboxes (DF 290 and DF 490)
A 08 152	Rack with two drawers (DF 290 and DF 490)
A 08 155	Cryobox 135x135 mm Height 75 mm
A 08 158	10x10 Divider for up to 12 mm Ø tubes. Divider height: 65 mm
A 08 159	9x9 Divider for up to 13.6 mm Ø tubes. Divider height: 65 mm
A 08 160	Diagram paper for chart recorder 0°C / -100°C (Pack of 100)
A 08 165	PP Cryobox 75x133x133 mm capacity 9x9 tubes
A 08 171	Cryobox 135x135 mm Height 50 mm
A 08 172	10 x 10 Divider for up to Ø 12 mm tubes. Divider height: 30 mm
A 08 173	9 x 9 Divider for up to 13.6 mm Ø tubes. Divider height: 30 mm
A 08 180	Rack for 135x135x50 mm cryoboxes (DF 290 and DF 490)
A 08 196	Rack with two drawers (DF 590)
A 08 197	Rack with three drawers (DF 590)
A 08 198	Rack for 133 x 133 x 75 mm cryoboxes (Rack capacity: 20 boxes) (DF 590)
A 08 199	Rack for 137 x 137 x 50 mm cryoboxes (Rack capacity: 25 boxes) (DF 590)
A 08 200	Rack for 135 x 135 x 50 mm PP cryoboxes (Rack capacity: 25 boxes) (DF 590)
A 08 070	Spare pen for chart recorder









Please contact NÜVE for different size of cryoboxes and racks.

3. PRECAUTIONS AND LIMITATIONS ON USE

The user shall pay attention to the following:

- Do not operate the instrument for purposes other than its main purpose.
- The instrument should only be used by authorized and trained staff after the instruction manual has been read carefully. Only authorized technical staff can handle the product in case of any failure.
- Only original spare parts and original accessories supplied by Nüve should be used.
- Correctly grounded power supply should be used.
- There should not be any material in the chamber that can damage to the device.
- The set temperature should not destroy the structure of the samples without user's notice.
- The maximum capacity of each compartment is 40 kg. Do not load the freezers more than the capacities in the compartment.
- Open the cover of the compartment that is used. Otherwise, temperature fluctuation may be observed.

4. SYMBOLS AND LABELS

	<p>Symbol in the operating instructions: Attention, general hazard area.</p> <p>This symbol refers to safety relevant warnings and indicates possibly dangerous situations. The non-adherence to these warnings can lead to material damage and injury to personal.</p>
	<p>Symbol in the operating instructions: This symbol refers to important circumstances.</p>
	<p>Notified Body: KIWA Belgelendirme Hizmetleri A.Ş. (İTOŞB) İstanbul Tuzla Organize Sanayi Bölgesi Tepeören Mevkii 34597 Tuzla- İstanbul / TURKEY</p>
	<p>Before operating the instrument this manual should be read carefully.</p>
	<p>Type B protection.</p>
	<p>This product is subject to the directive 2002/96/EC on Waste Electrical and Electronic Equipment (WEEE) of the European Parliament and of the EU Council of Ministers.</p>

Labels on the product:

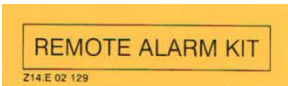
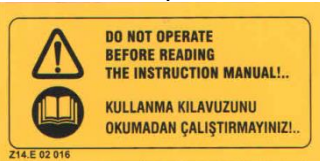

Eartherd
Wall
Sockets

Remote alarm output

Normally closed contact
output

DF 290 / DF 490/ DF 590
Fuses (2 x 13A)



5. INSTALLATION

5.1. ENVIRONMENTAL CONDITIONS

The instrument is designed to operate safely under the following conditions:

- Indoor use only
- Ambient temperature: 5°C to 30°C
- Maximum relative humidity for temperature up to 31°C: 80 %
- Maximum altitude: 2000 m
- Temperature for maximum performance: 15°C / 25°C



If ambient temperature is higher than 30°C, freezer may not operate properly and irreparable damages may occur.



The freezer operates at lower temperatures than -80 °C at maximum 20°C ambient temperature.

5.2. HANDLING AND TRANSPORTATION

All handling and transportation must be carried out by using proper equipment and experienced staff. The instrument must be supported underneath, moved in vertical position and never be turned upside down.

5.3. UNPACKING

Remove the cardboard box packing and ensure that no damage has occurred during transportation. Remove the second nylon wrapping around the instrument. The below mentioned are provided with the instrument, please check them;

- 1 ea. user's manual and warranty
- 1 ea. power switch key
- 2 ea. door handle key

5.4. MAINS SUPPLY

The instrument requires 230 V, 50 Hz.

Please make sure that the supplied mains matches the required power ratings which are written on the name plate of the instrument located at the back of the instrument.



Always plug-in the instrument to correctly grounded sockets.



A supply fitted with a circuit breaker should be used for protection against indirect contact in case of isolation fault.

5.5. POSITIONING

- Check that the positioning is suitable for the users.
- Check that the instrument is stable on its four feet.
- Check that the user will be able to follow up the operation even when he deals with something else.
- Check that the positioning of the device prevents interference with other equipment in the near surrounding.
- Ensure that the instrument is not exposed to sunlight directly.
- Leave at least 30 cm free space between the device and wall due to ventilation of compressor.

5.6. GENERAL PRESENTATION

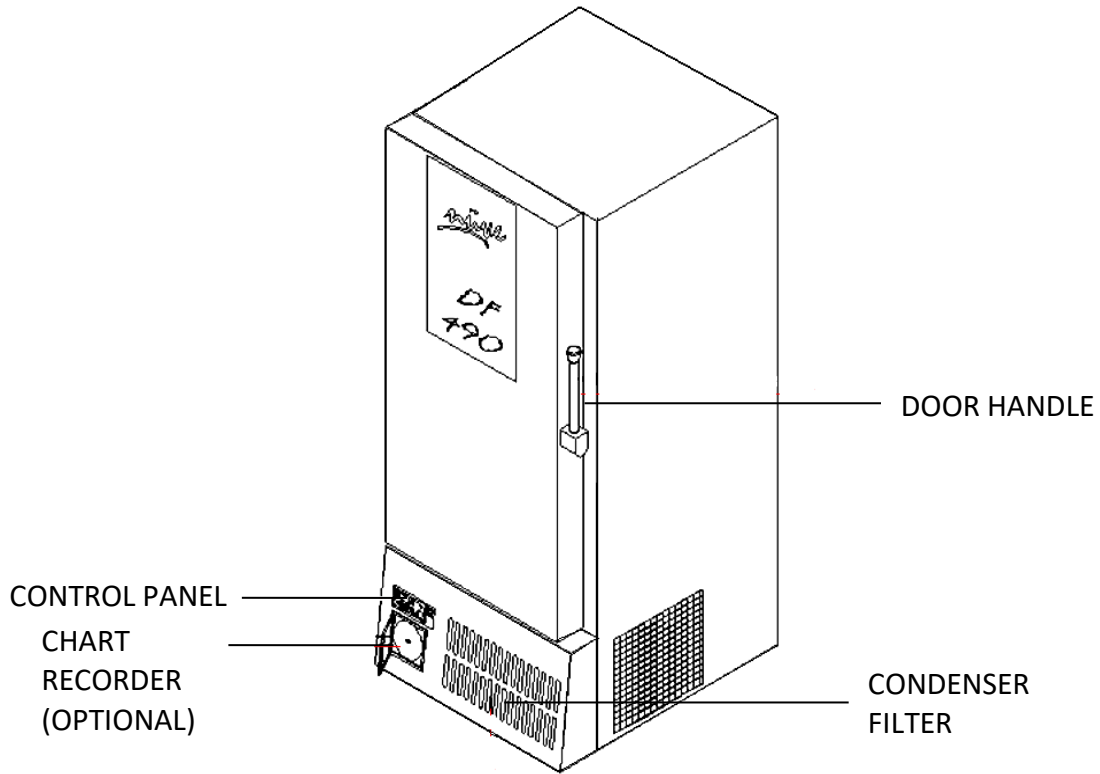

Figure 1

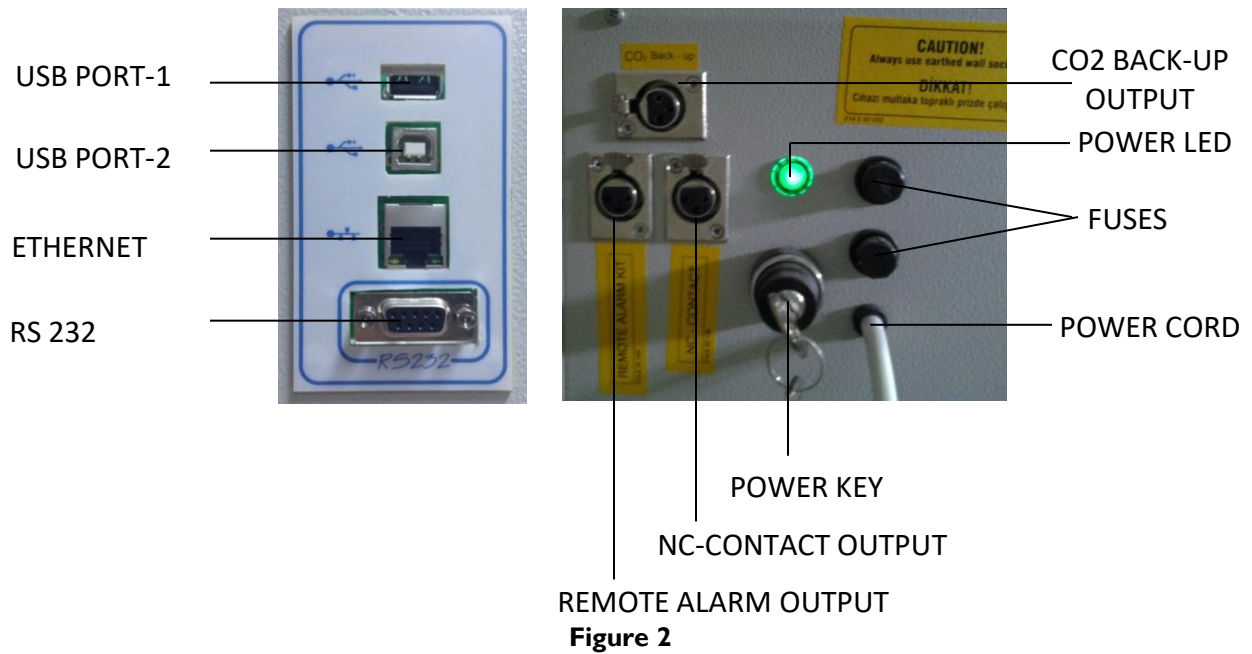
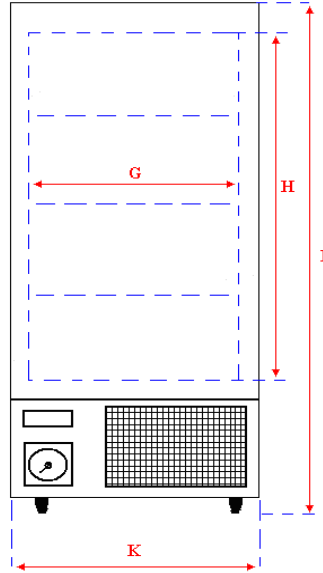
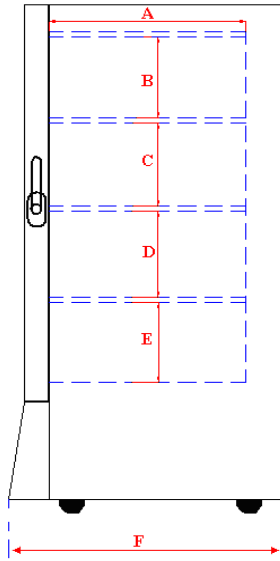

Figure 2

5.6.I. CHAMBER DIMENSIONS



	DF 290 *	DF 490	DF 590
A:	575 mm	610 mm	715 mm
B:	-	310 mm	310 mm
C:	310 mm	310 mm	310 mm
D:	310 mm	310 mm	310 mm
E:	310 mm	310 mm	310 mm
F:	1070 mm	965 mm	1120 mm
G:	420 mm	555 mm	555 mm
H:	995 mm	1320 mm	1320 mm
I:	1690 mm	2010 mm	2010 mm

*DF 290 has three compartments different from DF 490 and DF 590.

Figure 3

5.7. CONTROL PANEL

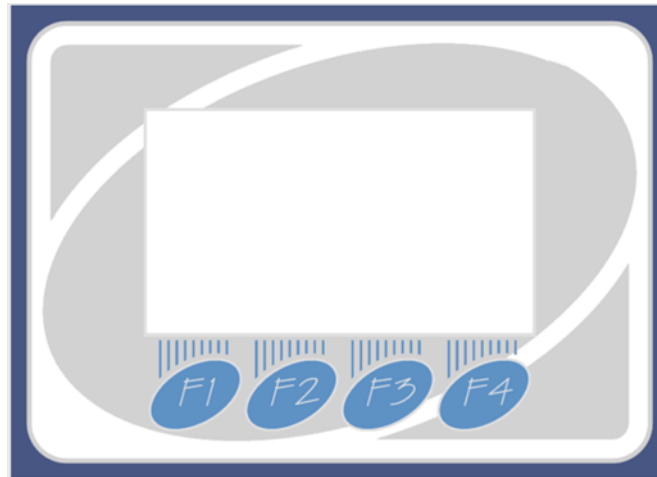











Figure 4

The functions of F1, F2, F3 and F4 buttons depend on the meaning of the corresponding symbol appearing on the display. The following table shows the meaning of these symbols.

	<p>This symbol denotes the menu. You can enter the menu by pushing the button corresponding to this symbol.</p>
	<p>This symbol denotes the settings page. You can enter the settings page by pushing the button corresponding to this symbol.</p>

	<p>This symbol denotes the graph screen. The last 24 hours of operation of the device can be monitored on the graph of the temperature vs. time by pushing the button corresponding to this symbol. It is recorded every 10 minutes.</p>
	<p>This symbol denotes the alarm range settings. You can adjust the temperature alarm range by pushing the button corresponding to this symbol.</p>
	<p>This symbol denotes the explanation of the error codes. You can learn detailed explanation about the error by pushing the button corresponding to this symbol. It appears in case of failures.</p>
	<p>This symbol denotes the alarm mute key. You can mute the audible alarm by pushing the button corresponding to this symbol when the alarm is activated in case of error.</p>
	<p>This symbol denotes backspace. You can return the previous page or exit from the page by pushing the button corresponding to this symbol.</p>
	<p>This symbol denotes the value increase key. You can increase the value by pushing the button corresponding to this symbol while adjusting the numerical values such as temperature or password.</p>
	<p>This symbol denotes the value decrease key. You can decrease the value by pushing the button corresponding to this symbol while adjusting the numerical values such as temperature or password.</p>
	<p>This symbol denotes the left key. It appears on the graph screen. The next graph appears when the button corresponding to this symbol is pushed.</p>
	<p>1) This symbol denotes the right key when the right and left keys appears on the same screen. The previous graph is passed when the button corresponding to this symbol is pushed. 2) It denotes the tab button when the left and the right keys do not appear on the same screen.</p>
	<p>This symbol denotes enter key. It is used for approval of adjustments.</p>

5.8. PRIOR TO OPERATION

- Plug-in the instrument to correctly grounded sockets.
- Insert the key to the power switch lock at the back.
- Power the freezer on by rotating the key clockwise.
- Observe that the microprocessor control system is activated.
- Learn the function of the control panel (See Section 5.7.).
- The ultra-low freezer starts automatically according to the last set temperature. You should set the temperature value according to your need (See Section 6.1.6).
- When ultra-low freezer starts to operate, the temperature of the chamber will appear on the control panel and audible and visual alarm will be activated. Push alarm mute key (F2) to mute the audible alarm. Temperature of chamber appears on the control panel during cooling process.



DF deep freezer will reach -80°C approximately in 6 hours if the chamber is not loaded. (This period depends on the ambient temperature.)



Suitable room conditions should be considered for best performance. Efficient performance at -86°C requires ambient temperature of 16°C .

6. OPERATING PRINCIPLES

6.1. PROGRAMMING



At most 70% of the surface area of the shelves should be loaded in order to obtain a uniform temperature distribution.



The temperature alarm range can be adjusted between 5°C and 25°C . Red colored screen meaning warning will be displayed when ultra-low freezer is operated for the first time and audible alarm will be activated. Push the alarm mute key (F2) to mute the audible alarm. The red screen turns into the blue when temperature in the chamber is in the temperature alarm range.

6.1.1. OPERATING MODE



When the ultra-low freezer is powered on, it starts to operate automatically according to the last set values. The screen on the left is operating mode screen on which set temperature and chamber temperature values appear. Current date and time are shown at the top of the screen. “❄️” icon flashes on this screen while the freezer cooling.

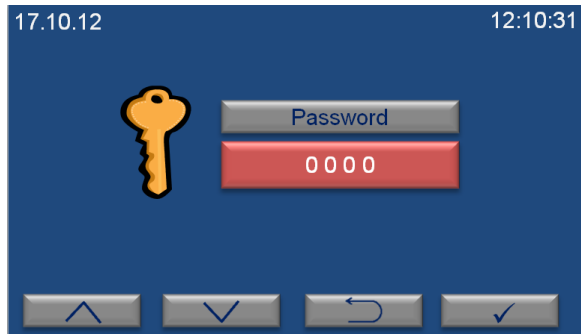

Password screen will appear when the MENU button (F1) is pushed. You can enter the password by using the value increase (F1) and decrease keys (F2). The password is user's password and can be changed on settings page (See section 6.1.2.). The password is 0000 for the first usage.

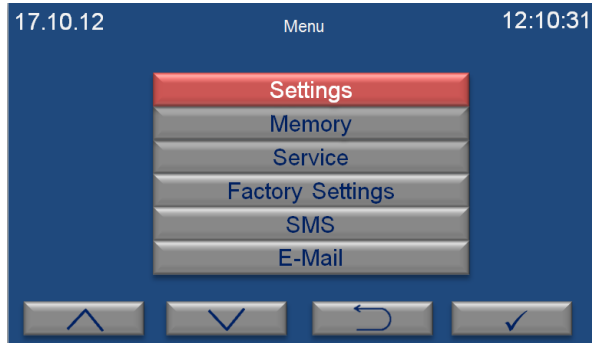

Main menu page appears when the password is approved by pushing enter key (F4). Submenu can be selected by using the value increase and decrease keys. The selected menu becomes red and enter key (F4) is pushed to enter this menu.

6.1.2. SETTINGS

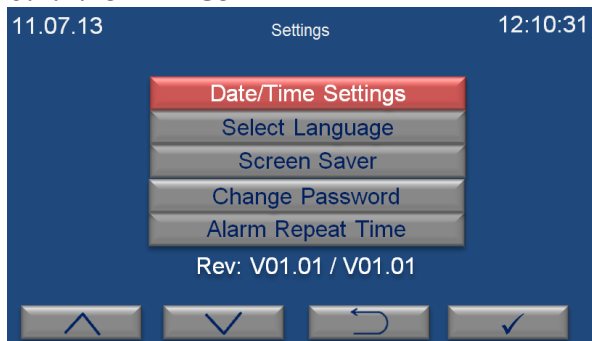

Settings page appears when "settings" submenu is selected from the menu page by the value increase (F1) and decrease (F2) keys. The required submenu is chosen by using the value increase and decrease keys.

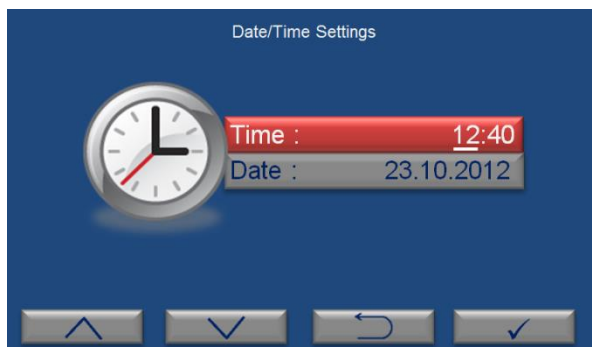

"Date/Time Settings" submenu is selected on the settings page by the value increase (F1) and decrease (F2) keys. The page shown on the left appears when enter key (F4) is pushed. Time is shown in the format of "hour:minute" and the cursor is on hour part when "Date/Time Settings" page comes to the screen. Hour is adjusted by pushing the value increase (F1) and decrease (F2) keys. In order to continue to adjust, push enter key (F4).

If you want to exit this page without any change, push the backspace key (F3).



“Select Language” submenu is selected on the settings page by using the value increase (F1) and decrease (F2) keys. The page on the left appears when enter key (F4) is pushed. The language of the control panel can be set as Turkish, English, French, Russian or Spanish. Push the value increase (F1) and decrease (F2) keys to select the language and then push the enter key (F4) to save the selection. If you want to exit this page without any change, push the backspace key (F3).

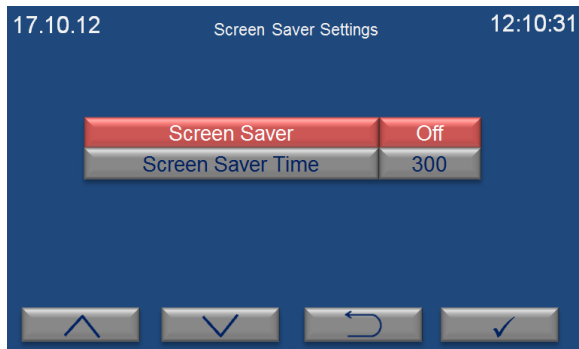

“Screen Saver Settings” submenu is selected on the settings page by using the value increase (F1) and decrease (F2) keys. The page on the left appears when enter key (F4) is pushed. Screen saver can be on or off by pushing the value increase (F1) and decrease (F2). If the option of “open” is selected, activation time of screen saver is adjusted on screen saver time in minutes. If you want to exit this page without any change, push the backspace key (F3).



It is suggested to use Screen Saver as ON for energy saving.

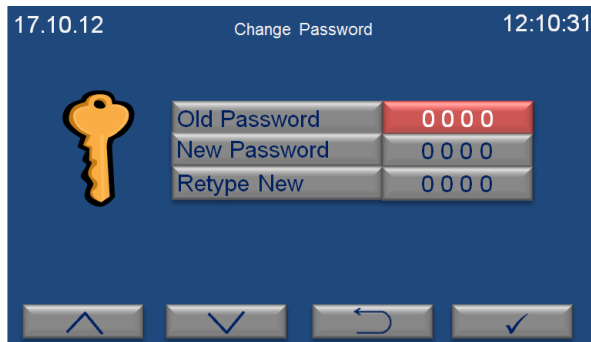

“Change Password” submenu is selected on the settings page by the value increase (F1) and decrease (F2) keys. The page on the left appears when enter key (F4) is pushed. After old password value is entered by pushing the value increase and decrease keys, push the enter key. New password value can be entered in the “New Password” and “Retype New” sections. If you want to exit this page without any change, push the backspace key (F3).

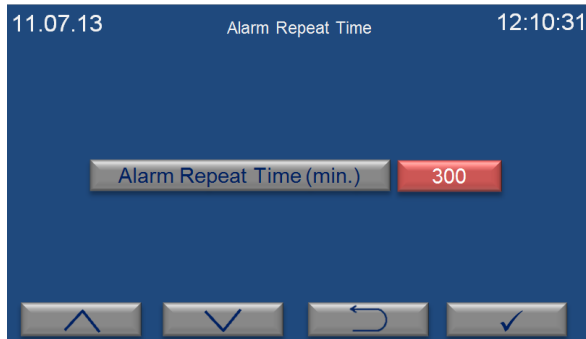

“Alarm Repeat Time” submenu is selected on the settings page by using the value increase (F1) and decrease (F2) keys. If the alarm condition continues after muting the alarm buzzer, “Alarm Repeat Time” reactivates audible alarm at the end of the desired time (in minutes). If you want to exit this page without any change, push the backspace key (F3).

6.1.3. MEMORY

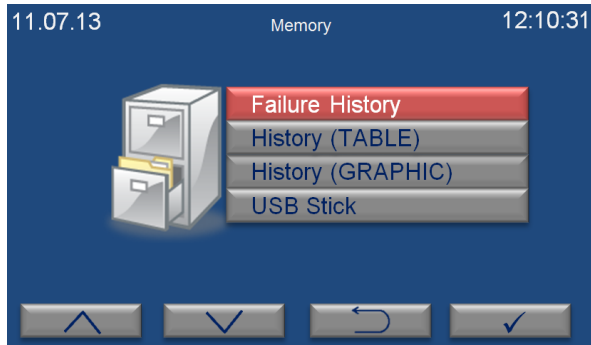

“Memory” submenu is selected on the menu page by the value increase (F1) and decrease (F2) keys. The page on the left appears when enter key (F4) is pushed.

6.1.3.1. INTERNAL MEMORY

The screenshot shows a table titled 'Error History 1' with columns for 'Error Name', 'Date', and 'Time'. The table contains five rows of error records. At the bottom, there are four navigation buttons: up arrow, down arrow, backspace, and enter.

Error Name	Date	Time
Err1	17.10.2012	12:10:31
Err1	16.10.2012	22:08:42
Err1	15.10.2012	10:10:11
Err1	14.10.2012	12:00:01
Err1	13.10.2012	09:42:53

“Failure History” submenu is selected on the memory page by the value increase (F1) and decrease (F2) keys. The page on the left appears when enter key (F4) is pushed. The last 50 failures can be followed on this page. There are 10 pages in total for error history and 5 failures are listed on each page. Failures are listed from the current date to the earlier. Push the value increase (F1) and decrease (F2) keys to pass the other page.

Push the backspace key (F4) in order to exit the page.

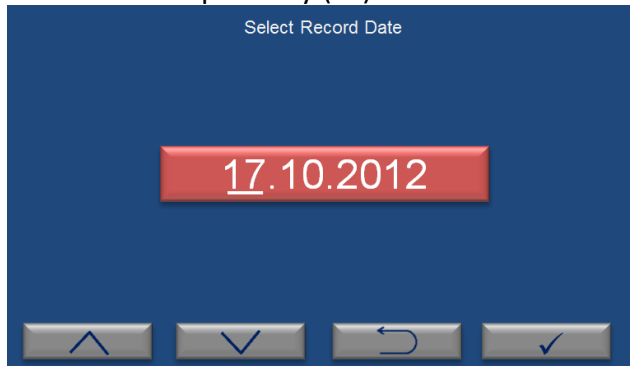

“History (TABLE)” submenu is selected on the memory page by the value increase (F1) and decrease (F2) keys. The page on the left appears when enter key (F4) is pushed. Enter a date to analyze corresponding operation by pushing the value increase and decrease keys. Push the enter key (F4) to access the table.

The screenshot shows a table titled '11.07.2013 -1-' with columns for 'Time' and 'Temperature'. The table is split into two columns, each with four rows of data. At the bottom, there are four navigation buttons: up arrow, down arrow, backspace, and enter.

Time	Temperature	Time	Temperature
00:00	-41	01:00	-41
02:00	-41	03:00	-41
04:00	-41	05:00	-41
06:00	-41	07:00	-41

Temperature values corresponding to the selected date are shown on three pages. Push the value increase (F1) and decrease (F2) keys to pass from one page to another. “-” appears in the temperature column if the freezer does not run on the selected date. Push the backspace key (F3) to return previous page.



When the temperature sensor is broken, “-” appears in the temperature column since temperature cannot be read by the sensor.

“History (GRAPH)” submenu is selected on the memory page by the value increase (F1) and decrease (F2) keys. “Select Record Date” page appears when enter key (F4) is pushed. Enter a date to analyze corresponding operation and then push the enter key (F4). You can analyze the data in the graph. The data belonging to the other dates can be followed by using left (F2) and right (F3) keys. Push the backspace key (F4) to return the previous page.

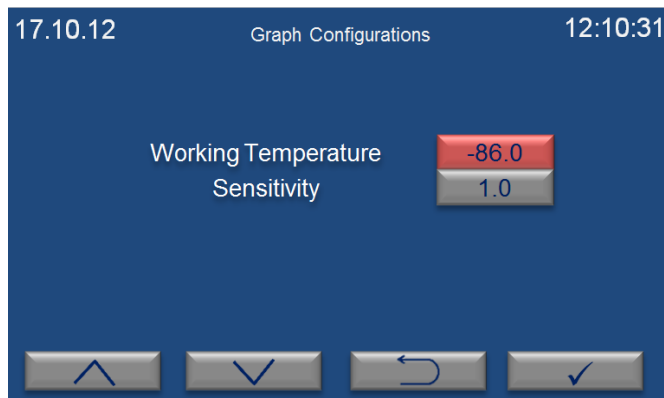

The page on the left appears when the settings key (F1) is pushed on the graph page. Temperature axis (y-axis) can be adjusted on this page. Working temperature determines the midpoint of the temperature axis. The working temperature value should be close to the set temperature value for more comfortable observation. Sensitivity value is the difference between two values on the y-axis. As the sensitivity value getting smaller, a more detailed graph appears.

6.1.3.2. EXTERNAL MEMORY (USB STICK)

USB Stick is connected to USP port-1 of the communication unit (Figure 2). “” appears on the operating mode screen when the USB stick is identified by the microprocessor system.



If  does not appear on the screen, USB stick may be defective or may not be connected correctly.

When “USB Stick” submenu is selected on the memory page, there are three options: “Copy History”, “Instant Record” and “Copy Failure History”.

Copy History: As USB stick is connected to the device, all data in the internal memory is transferred to USB stick when “Copy History” is selected. When loading bar shows 100%, push the enter key (F4) to exit the page.

Instant Record: As USB stick is connected to the freezer, the page on the right appears when “Instant Record” is selected. The period of the record time can be selected by using the value increase (F1) and decrease (F2) keys. As soon as the enter key (F4) is pushed, recording starts and the display returns the main page. If you want to exit this page without starting to record, push the backspace key (F3). You can remove USB stick when you want to finish the record process.

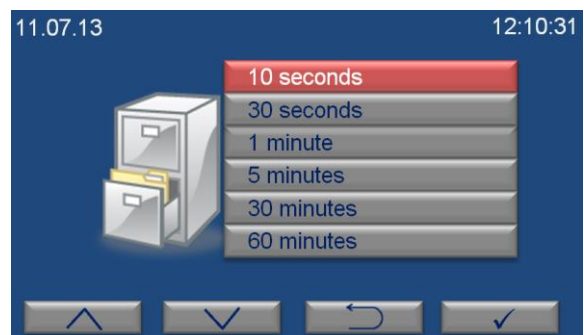

Copy Failure History: As USB stick is connected to the device, all error history in the internal memory is transferred to USB stick when “Copy Failure History” is selected. When loading is finished completely, push the enter key (F4) to exit from this page.

6.1.4. SMS

 In order to use SMS, optional GSM module is mandatory to have. Refer to Section 10.1 for information regarding GSM module connection.



“SMS” submenu is selected on the menu page by the value increase (F1) and decrease (F2) keys. The page on the left appears when enter key (F4) is pushed. Submenus on SMS page is selected by using increase (F1) and decrease (F2) keys. Selected submenu can be adjusted by using enter key (F4). If you want to exit the page, push the backspace key (F3).

- Activation or deactivation of SMS function can be adjusted on “SMS” submenu. If you want to activate this function, choose “on” by pushing the enter key (F4). If you want to deactivate SMS function, choose “Off” by pushing the enter key (F4).
- “Repeat time” is the frequency of sending SMS. The user is notified again by sending SMS if the failure still continues. Repeat time can be adjusted to 8 hours, 16 hours and 24 hours by pushing enter key (F4).

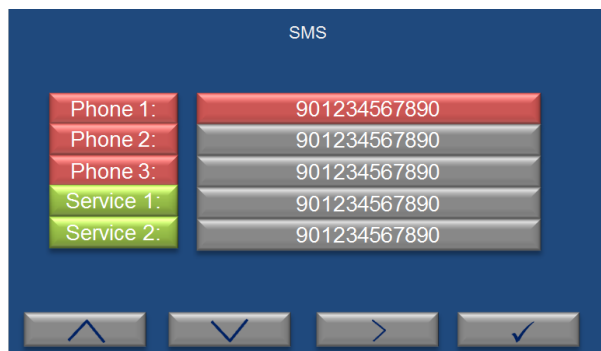

“SMS Numbers” is selected on the SMS page by using the value increase (F1) and decrease (F2) keys. The page on the left appears when enter key (F4) is pushed. The phone numbers can be entered in this page and SMS notifications are delivered to these phone numbers in case of any failure.

- SMS can be sent to 5 different mobile phones. According to demand, 1st, 2nd and 3rd numbers can be users’ numbers and 4th and 5th numbers can be technical service staffs’ numbers.
- Enter country code before the phone numbers.
- A cursor flashes under a digit which means you can set this digit of the number. Each digit of phone numbers is entered one by one. The first digit of the phone number is entered by pushing value increase (F1) and decrease keys (F2) and tab key (F3) is pushed to enter the second digit. The second number is entered pushing value increase (F1) and decrease keys (F2) and tab key (F3) is pushed to enter the next digit. After all digits of the phone number are entered completely by this way, push the enter key (F4) to enter the next phone number.

- Tab key (F3) is used for changeover from one digit of phone number to another.
- After all phone numbers from “Phone 1” to “Service 2” is entered as mentioned above, push the enter key (F4) and return to main page.

6.1.5. E-MAIL

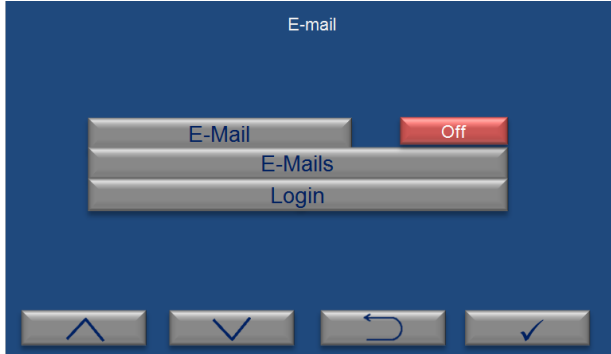

“E-Mail” submenu is selected on the menu page by the value increase (F1) and decrease (F2) keys. The page shown on the left appears when enter key (F4) is pushed. The choice of submenus on e-mail page is changed by pushing increase (F1) and decrease (F2) keys. After choosing a submenu, the adjustments for this submenu is made by pushing enter key (F4). If you want to exit this page, push the backspace key (F3).

- Activation or deactivation of e-mail function can be adjusted from “E-mail” submenu. If you want to activate this function, choose “on” by pushing the enter key (F4). If you want to deactivate e-mail function, choose “off” by pushing the enter key (F4).

 Ethernet settings should be adjusted by technical service staff for the first usage. Otherwise, this function does not work.

- “E-Mails” is the page which e-mail addresses will be written on.
- “Login” is the adjustments for the e-mail addresses.

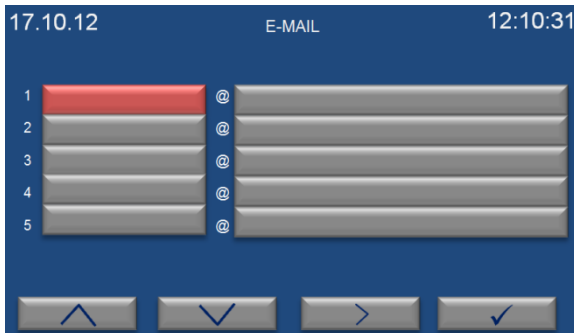

“E-Mails” is selected on the e-mail page by the value increase (F1) and decrease (F2) keys. The page on the left appears when enter key (F4) is pushed. The e-mail addresses can be typed in this page and e-mail is sent to these addresses in case of any failure.

- Each character of e-mail addresses is typed one by one. The first character is entered by pushing value increase (F1) and decrease keys (F2) and tab key (F3) is pushed to enter the second character. The second character is written by pushing value increase (F1) and decrease keys (F2) and tab key (F3) is pushed to enter the next character. After all characters are written completely in this way, push the enter key (F4) to enter the mail server. After mail server is written in the same way, push the enter key (F4) to write next e-mail address.
- After all e-mail addresses from 1 to 5 are written as mentioned above, push enter key (F4) and return to main page.
- Tab key (F3) is used for changeover from one character of address to another.

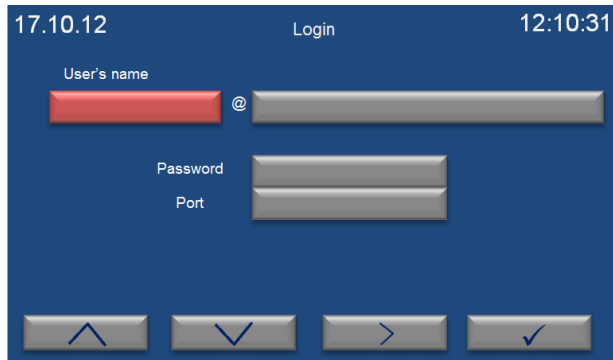

“Login” is selected on the e-mail page by the value increase (F1) and decrease (F2) keys. The page on the left appears when enter key (F4) is pushed. Each character of e-mail addresses is written one by one. The first character is entered by pushing value increase (F1) and decrease keys (F2) and tab key (F3) is pushed to enter the next character. The second character is entered by pushing value increase (F1) and decrease keys (F2) and tab key (F3)

is pushed to enter the next character. After all characters of user’s name are entered by this way, push enter key (F4) to enter the mail server of the e-mail address. After mail server is entered in the same way, push enter key (F4) to pass the “password” submenu.

Enter the password and push enter key (F4).

The port provided by internet server is entered on the part of “Port”. After port is entered, enter key (F4) is pushed to return the main menu. Tab key (F3) is used for changes from one character of address to another.

6.1.6. SET TEMPERATURE

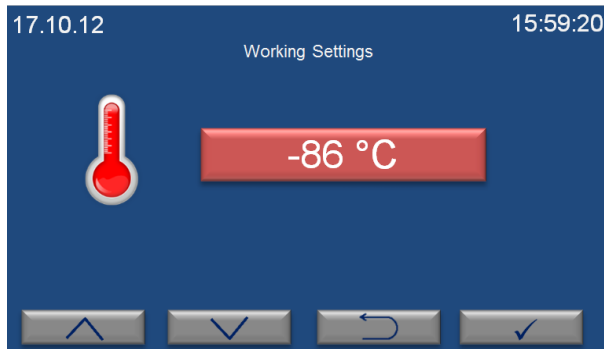

When the setting key (F2) is pushed in the operation mode, password page appears. This password is the user’s password. The password is 0000 for the first usage. “Working Settings” page on the left appears. The set temperature can be adjusted between -45°C and -90°C by pushing the value increase (F1) and decrease (F2) keys. After set temperature value is entered, push the enter key (F4) to save the value. If you want to exit this page without any change, push the backspace key (F3).

 In case of active audible alarm, firstly, push the alarm mute key (F2) to access the working settings page.

6.1.7. GRAPH WORKING SCREEN

When the graph button (F3) is pushed in the operation mode, the graph page comes to the screen. Daily operation can be followed on this graph. If you want to analyze previous operations, visit the memory page (See Section 6.1.3).

6.1.8. TEMPERATURE ALARM RANGE

Temperature alarm range can be set between 5°C to 25°C. In the factory, temperature alarm range is adjusted to 10°C; however, you can change this value by carrying out the steps mentioned below.

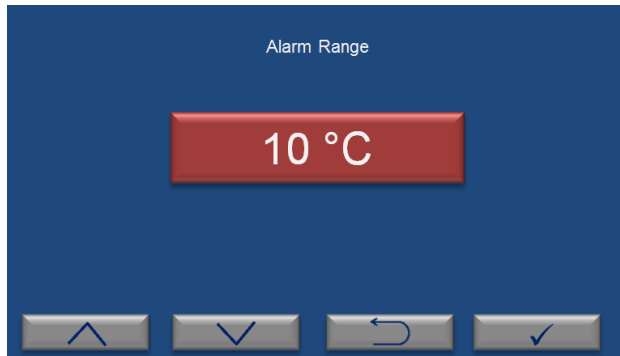

When the temperature alarm setting key (F4) is pushed in the operation mode, the “Alarm Range” page shown on the left appears. The desired alarm value can be adjusted by pushing value increase (F1) and decrease (F2) keys. Enter key (F4) is pushed to save the value and returned to the working screen. If you want to exit this page without any change, push backspace key (F3).

7. PERIODIC MAINTENANCE AND CLEANING

7.1. PERIODIC MAINTENANCE

The dust and grease settled on the condenser fin reduce the area of the heat exchange and thus efficiency of freezer decreases. Therefore, the condenser filter should be cleaned once in a month. To access condenser filter, pull out the front panel of the compressor compartment (See Figure 5). Take out the filter and clean the filter with compressed air. Place the filter again on the front panel of the compressor compartment.

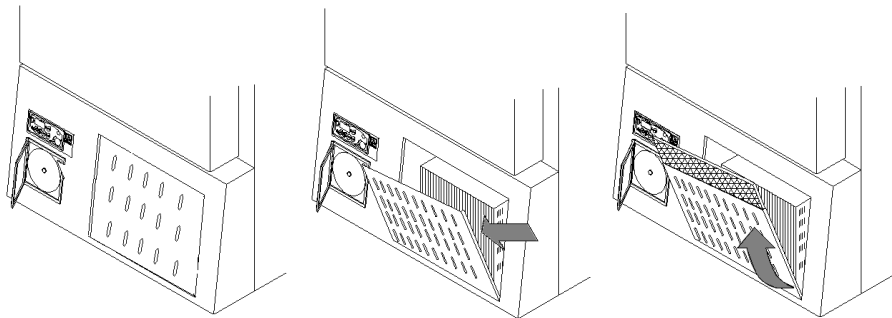



Figure 5

Icing on the door gasket may be observed. In this case, the door will not be closed strictly and the icing in the chamber will start. Therefore, the cooling may not be effective. Please check regularly whether there is any icing at the door gasket.

 If excessive icing is observed, it is suggested to turn off the freezer and wait for 12 hours.

Clean the chamber with surface disinfectant (%70 Alcohol, %2 glutaraldehyde). Do not use solutions including chlorine for cleaning.

7.2. CLEANING

- Clean the refrigerator and at room temperature after disconnecting the power cable.
- Clean the refrigerator with a damp cloth to remove dirt and dust.
- Use liquid detergent to remove tough dirt.
- Take precautions while handling chemical cleaners.
- Check the external condition of the refrigerator regularly and ensure any rust spots that may develop are removed.
- Ensure that the temperature of chamber is reached to ambient temperature before cleaning.
- Ensure that there is no ice on the shelves. Do not inscribe layer of ice if there is ice on shelves.

8. DISPOSAL MANAGEMENT CONCEPT

The currently valid local regulations governing disposal must be observed. It is in the responsibility of the user to arrange proper disposal of the individual components.

All parts which may comprise potentially infectious materials have to be disinfected by suitable validated procedures (autoclaving, chemical treatment) prior to disposal. Applicable local regulations for disposal have to be carefully observed.

The instruments and electronic accessories (without batteries, power packs etc.) must be disposed off according to the regulations for the disposal of electronic components.

Batteries, power packs and similar power source have to be dismantled from electric/electronic parts and disposed off in accordance with applicable local regulations.

9. TROUBLESHOOTING

If the device fails to operate, please check the followings:

- The power switch is on;
- The fuse is sound;
- The plug is plugged-in properly;
- The plug is not defective;
- The mains supply is present.

9.1. ERROR CODES

Blue colored screen turns into red in case of any failure and a short explanation of the error appears at the bottom line on the red screen. Push the key corresponding to question mark (F3) for detailed explanation of failures. Failures which may be encountered during operation is listed below:

EoFF: This error code shows power failure.



After power interruption, push the key corresponding to question mark (F3) in order to see the time when power interruption occurs.

Err1: It appears when temperature sensor is defective.

Err2: It appears when there is a communication error between display and main PCB.

Err3: It shows that condenser filter is clogged.

Err4: It appears when there is a failure in refrigeration group.

Err5: It appears when door is kept open longer than determined time.

Err6: It shows that the temperature in the chamber is not in the temperature alarm range. It is shown only in the list of the error history. "Out of range" appears on the screen.

Err7: It appears when software version is not compatible. Push the F3 key corresponding to the question mark to see the explanation. Inform the authorized NÜVE agent regarding the error explanation.



A list consisting of the codes of errors can be accessed from the memory page (See section 6.1.3.1). 'EoFF', 'Err3', 'Err4', 'Err5' and 'Err6' do not appear on working screen and they are only shown in the list of the error history.



If an error occurs, please contact to an authorized NÜVE agent to seek technical help.

9.2. FUSE REPLACEMENT

The fuses shall always be replaced by authorized personnel.

10. OPTIONS

10.1. AlerText™ GSM MODULE

In case of error, DF series can send SMS to five different phone numbers by GSM module as an option.



Figure 6

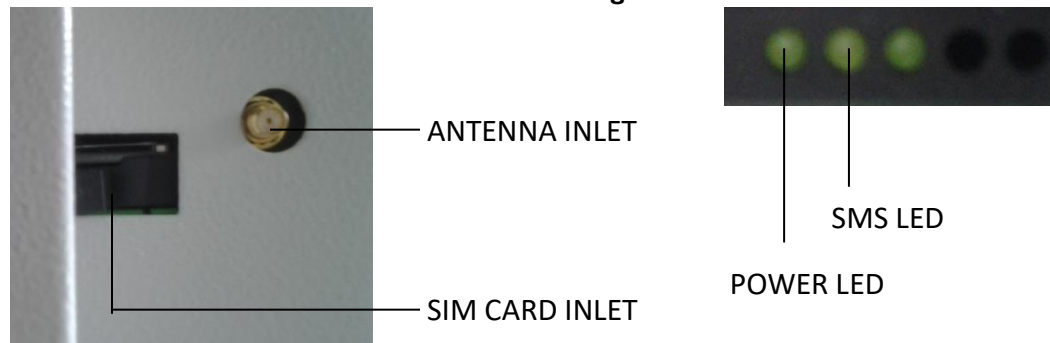

Figure 7

Figure 8

Please carry out the following steps for connection of GSM module:

- Insert SIM card in the GSM module (See Figure 7).



SIM card is provided by the user. The cost of SIM card and SMS differs according to the GSM providers and all the charges will be covered by the user.



SIM card which will be used for GSM module should not have PIN code.

- Plug-in the GSM module to correctly grounded sockets.
- Connect the end of RS 232 cable of GSM module (See Figure 6) to the RS 232 port on the ultra-low freezer (See Figure 2).
- Ensure that power led is turned on (See Figure 8). Power led is on when energy is supplied to the GSM module. SMS led starts to flash while the module sending SMS.
- Connect the antenna cable to antenna inlet on the GSM module (See Figure 7).

Antenna has magnet to place it easily. Place the antenna on a place where the signal of GSM module is high.



If the GSM module is not connected or does not send messages although it is connected, “modem” error code appears in the error history. If the GSM module is connected and cannot send messages, “SMS” error code appears in the error history. Modem and SMS errors do not appear when SMS submenu on the SMS page is selected as “off”.

10.2. NüveWARN™ REMOTE ALARM SYSTEM

DF series Ultra-Low Freezers have remote alarm system. This feature can be used only if an optional remote alarm kit is connected to the freezer.

The remote alarm will be activated for all alarm situations as power failure, open door, and broken temperature sensor.

10.2.1. MOUNTING REMOTE ALARM

The remote alarm kit includes an alarm unit and 10 meters of cable with a connector. Connect one side of the cable to the connector at the rear of the refrigerator and the other side to the alarm unit.



Mount the remote alarm kit to a wall or board not more than 10 meters away from the refrigerator where it is easily accessible and observable.

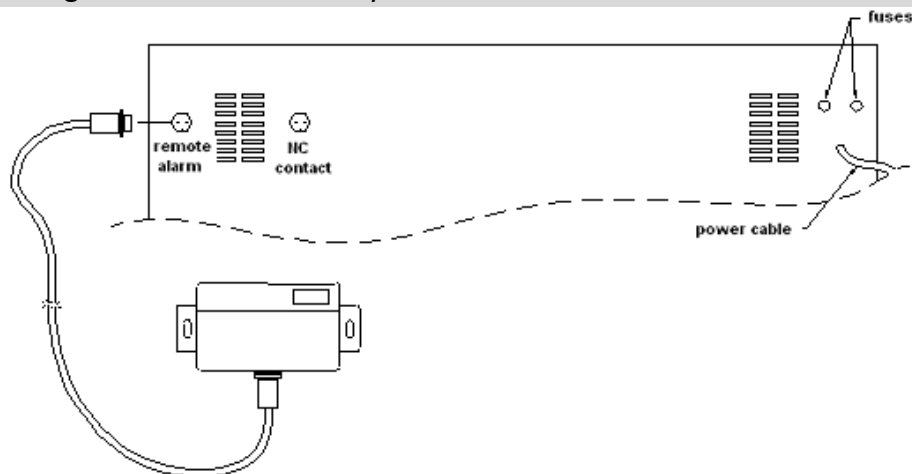

Figure 9

10.3. CHART RECORDER

The below mentioned are provided with the chart recorder, please check them;

- 100 ea. circular diagram paper for chart recorder
- 1 ea. pen for chart recorder
- 1 ea. battery
- 2 ea. circular recorder keys.

Chart recorder measures the temperature in the chamber and records this value by using a pen.

- Chart recorder is assembled on the device in case of customer request.
- Open the lid of the circular recorder by using the key. Unscrew the nut in the center (1) by rotating it to counterclockwise as shown in Figure 10.
- Pull the battery unit and take it out. Put on the battery supplied with device to the hole at the back of the unit by paying attention to + and – poles. Always use leak protected high quality batteries.
- Put the battery unit to its place.
- Turn the nut in the center (1) to counterclockwise direction.
- Put on one of the circular recorder papers supplied with the device, printed side facing towards out (2).
- Replace nut and turn it to clockwise direction.
- Adjust the paper according to the pen by considering day and hour lines.
- Insert the chart recorder pen (3) to the handle carefully and remove the cap on the pen.
- Close the circular recorder lid.

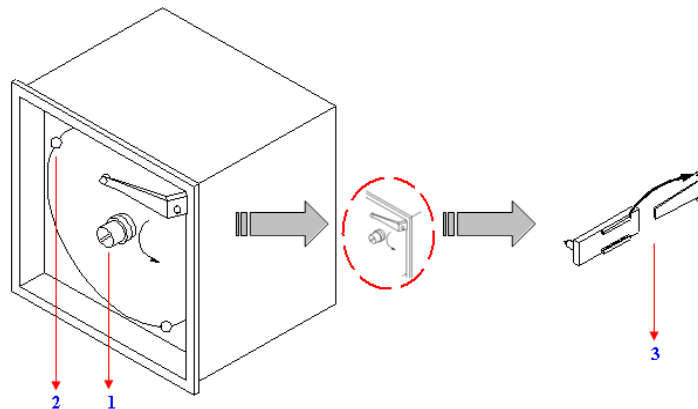

Figure 10

10.4. CO₂ BACK-UP UNIT

With the help of injection of liquid CO₂ into deep freezer chamber, stored samples are kept at -60°C in a few hours in case of any power or compressor failure. CO₂ feedback unit must be assembled by service technician (Figure 11).

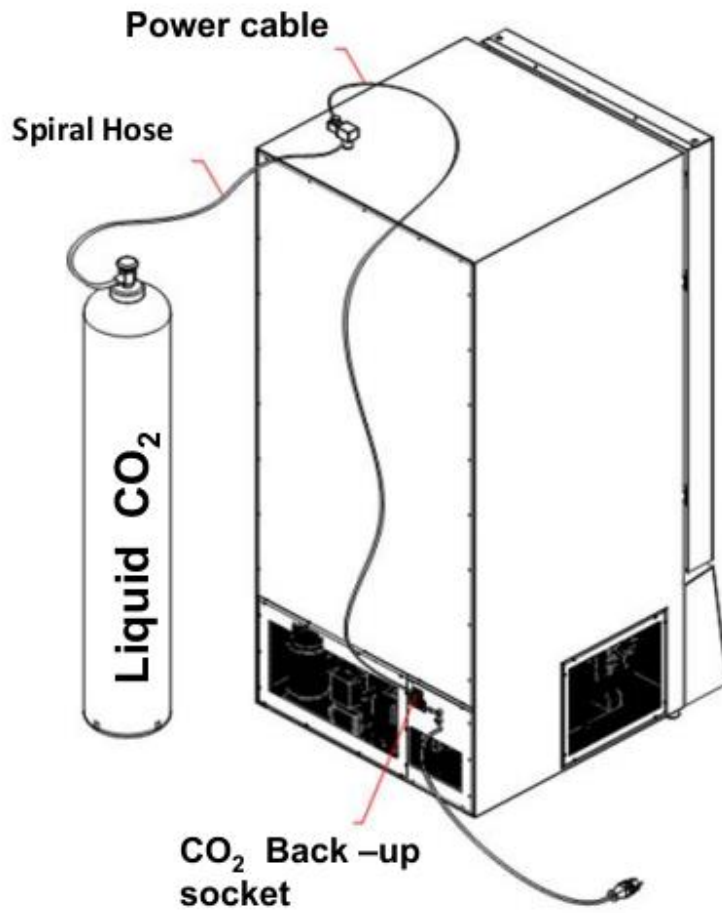

Figure 11

I. ELECTRICAL CIRCUIT DIAGRAM

I. I. DF 290, DF 490 AND DF 590 ELECTRICAL CIRCUIT DIAGRAM

