



Brugsvejledning	DK	4
Bruksanvisning	SE	13
Käyttöohje	FI	22
Instruction manual	UK	31
Bedienungsanleitung	DE	40
Mode d'emploi	FR	49
Handleiding	NL	58
Manual de instrucciones	ES	67
Manual de Instruções	PT	76
Руководство по эксплуатации	RUS	85

DK Indholdsfortegnelse

Vigtige instruktioner	4
Udpakning og opstilling	4
EI-tilslutning	5
Opstart	5
Termostaten	6
Termometer	6
Afrimning	7
Lås	7
Lys	7
Udskiftning af lys	8
Vending af dør	9
Vægbeslag	10
Vedligeholdelse	11
Service	12
Bortskaffelse	12
Tekniske data	85

FI Sisältö

Tärkeitä turvallisuusohjeita	22
Pakkauksesta purkaminen ja asennus	22
Sähköiset liitännät	23
Laitteen käynnistäminen	23
Termostaatti	24
Lämpömittari	24
Sulatus	25
Lukko	25
Sisävalo	25
Lampun vaihto	26
Oven käтisyiden vaihtaminen	27
Seinäasennus	28
Ylläpito ja puhdistus	29
Huolto	30
Hävittäminen	30
Tekniset tiedot	85

DE Inhalt

Wichtige Informationen	40
Auspackung und Aufstellung	40
Anschließen	41
Starten	41
Thermostat	42
Thermometer	42
Abtauen	43
Schloß	43
Licht	43
Auswechslung vom Licht	44
Wechsel vom Türanschlag	45
Wandbeschlag	46
Wartung	47
Service	48
Entsorgung	48
Technische Daten	85

SE Innehåll

Viktiga säkerhetsanvisningar	13
Uppackning och installation	13
Elektriska anslutningar	14
Starta skåpet	14
Termostat	15
Termometer	15
Avfrostning	16
Lås	16
Innerlampa	16
Byta ut lampan	17
Vända dörren	18
Väggfäste	19
Underhåll och rengöring	20
Service	21
Bortskaffande	21
Tekniska data	85

UK Contents

Important safety instructions	31
Unpacking and installation	31
Electrical connections	32
Start-up of the cabinet	32
Thermostat	33
Thermometer	33
Defrosting	34
Lock	34
Internal light	34
Replacing the Light	35
Door reversal	36
Wall fitting	37
Maintenance and cleaning	38
Service	39
Disposal	39
Technical data	85

FR Sommaire

Consignes de sécurité importantes	49
Déballage et installation	49
Raccordement électrique	50
Démarrage	50
Thermostat	51
Thermomètre	51
Dégivrage	52
Serrure	52
Éclairage	52
Remplacement éclairage	53
Changement de côté des charnières de la porte	54
Support mural	55
Entretien	56
Service	57
Mise au rebut	57
Spécifications techniques	85

NL

Belangrijke veiligheidsvoorschriften	58
Uitpakken en installeren	58
Elektrische aansluitingen	59
De kast starten	59
Thermostaat	60
Thermometer	60
Ontdooien	61
Slot	61
Interne verlichting	61
De lamp vervangen	62
Deur omkeren	63
Tegen de muur bevestigen	64
Onderhoud en reiniging	65
Onderhoud	66
Verwijderen	66
Technische gegevens	85

PT

Instruções importantes de segurança	76
Desembalar e instalação	76
Ligações Eléctricas	77
Arranque da arca	77
Termóstato	78
Termómetro	78
Descongelamento	79
Bloqueio	79
Iluminação interna	79
Substituição da lâmpada	80
Inversão da porta	81
Montagem na parede	82
Manutenção e Limpeza	83
Assistência Técnica	84
Eliminação	84
Dados técnicos	85

ES

Instrucciones de seguridad importantes	67
Desembalaje e instalación	67
Conexión eléctrica	68
Puesta en marcha de la unidad	68
Termostato	69
Termómetro	69
Descongelación	70
Cierre	70
Luz interna	70
Sustitución de la lámpara	71
Inversión de la puerta	72
Instalación en pared	73
Mantenimiento y limpieza	74
En caso de avería	75
Eliminación	75
Datos técnicos	85

RUS

<i>Under construction.</i>	85
----------------------------	----

Vigtige instruktioner:

De i dette dokument beskrevne kølere, er udelukkende designet til opbevaring og afkøling af drikkevarer i flasker eller dåser.

- For at få det fulde udbytte af skabet, bør De læse denne brugsvejledning igennem.
- Det er brugers ansvar at anvende skabet i henhold til instruktionerne.
- Kontakt omgående forhandleren, såfremt der opstår fejl ved skabet.
- Skabet er kun til indendørs brug.
- Skabet bør anbringes i et tørt og tilstrækkeligt ventileret rum.
- Skabet bør ikke placeres i nærheden af varmekilder eller direkte sollys.
- Skabet bør ikke placeres i nærheden af ventilations/airconditions-anlæg.
- Bemærk at alle elektriske apparater kan medføre farer.
- Opbevar ikke eksplosionsfarlige stoffer, f.eks. gas, benzin, æter og lignende i skabet.
- Der er ikke brugt asbest eller CFC i konstruktionen.
- Olien i kompressoren indeholder ikke PCB.



- DETTE SKAB SKAL ALTID TILSLUTTES ET STIK MED JORDFORBINDELSE !
- VED REPARATION SKAL STIKKET TAGES UD AF STIKKONTAKTEN !



- KUN FOR SKABE MED R600a KØLEMIDDEL !

- Dette skab indeholder er brændbart kølemiddel, sørg derfor for god ventilation omkring skabet.
- Brug ikke mekanisk værktøj til afrimning, da dette kan forårsage utætheder på kølesystemet.
- Brug ikke elektrisk værktøj inden i skabet.
- Enhver reparation på dette skab skal udføres af en kvalificeret reparatør. (EN 60335-2-89: 2010)

Udpakning og opstilling:

Fjern al emballage og kontroller for transportskader.

Eventuelle transportskader skal straks anmeldes til transportøren.

- Ved indbygning, skal der sikres en afstand bagved og over skabet på mindst 50 mm.
- Sørg for at luftindtaget i bundpanelet ikke blokeres.
- For korrekt funktion er det vigtigt at skabet står lige, dette kan sikres ved at justere fødderne:

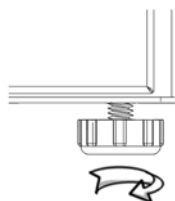

El-tilslutning

Skabet er beregnet for tilslutning til 220-240 V/50 Hz. Tilslutningen skal ske ved en stikkontakt, der bør være let tilgængelig.

Dette kølemøbel skal ekstrabeskyttes ifølge stærkstrømsreglementet. Dette gælder også, selvom der er tale om udskiftning af et eksisterende kølemøbel, der ikke har været ekstrabeskyttet.

I alle tilfælde skal der benyttes en trebenet stikprop, og lederen med grøn/gul isolation skal tilsluttes jordklemmen (mærket ⊕).

I alle andre tilfælde bør De lade en autoriseret el-installatør undersøge, hvordan De nemmest får ekstrabeskyttet skabet. Hvis De ikke har ekstrabeskyttelse i bygningen i forvejen, anbefaler Elektricitetsrådet, at De lader el-installatøren opsætte en PFI- eller HPFI afbryder.

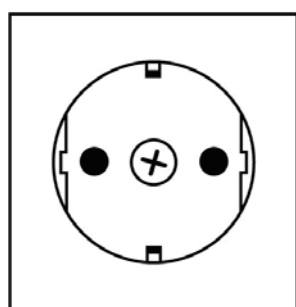

230 V_~ 50 Hz



13 A

Skabet skal tilsluttes et 13 A. beskyttet strømudtag.

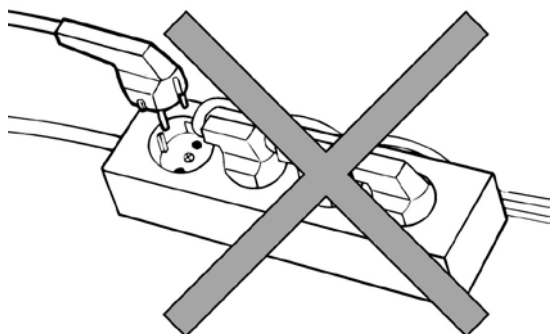

Skabet bør ikke tilsluttes en flerpolet fordelingsdåse.

Opstart

Inden skabet tages i brug, anbefales det at rengøre dette, se afsnit om vedligeholdelse.

Vigtigt !

Hvis skabet har ligget ned under transport, vent 2 timer før opstart.

Termostaten (Se også side 90)

Termostaten kan indstilles på en skala fra 1-7, hvilket svarer til ca. 2-12 °C.
En indstilling på 3-4 vil i de fleste tilfælde være optimal.
Kølesystemet kan frakobles ved en indstilling på 0.

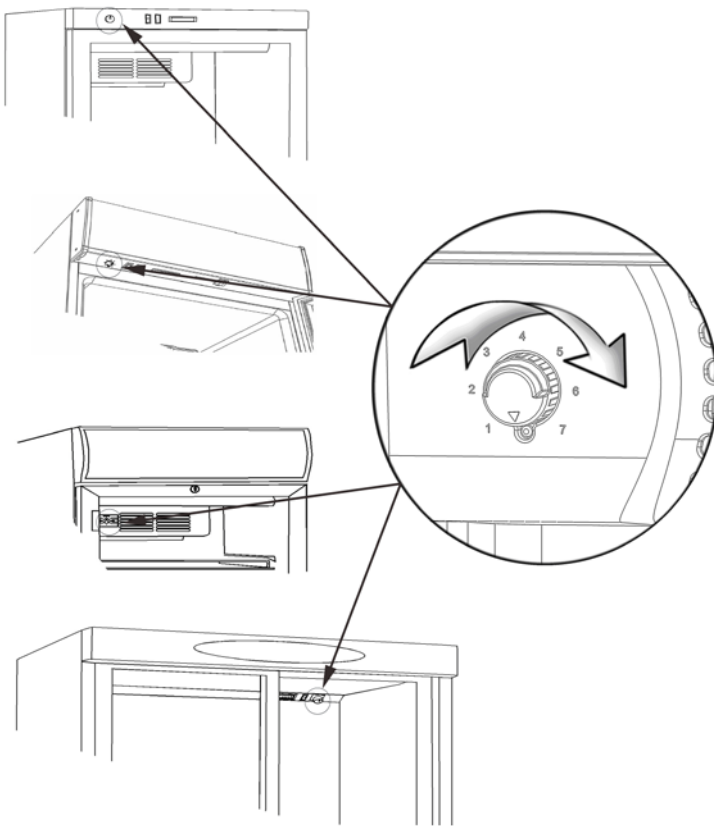

Termostaten kan alt efter model være placeret:

1. I toppanel.
2. Under canopy.
3. I afdækning af intern ventilator.

Termometer

Alle skabe er udstyret med et termometer.

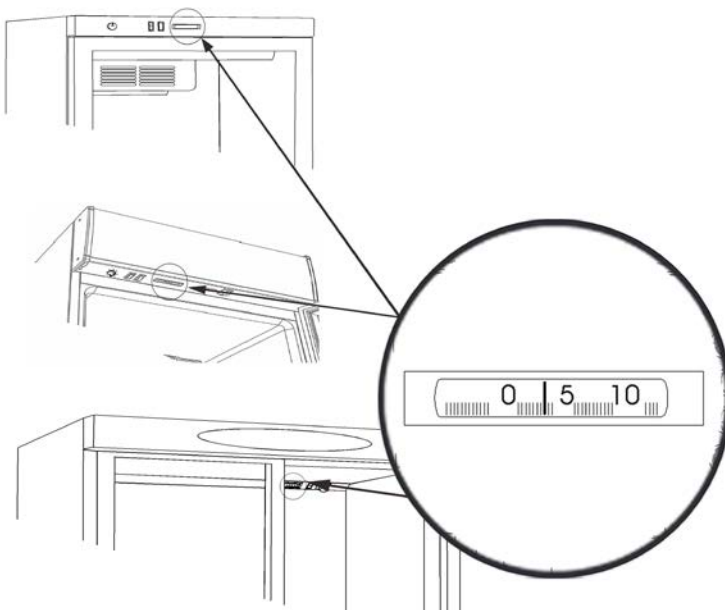

Termometeret kan alt efter model være placeret:

1. I toppanel
2. Under canopy.

Afrimning

Skabet afrimer automatisk. Tøvand ledes ud til fordampning i en beholder, der er placeret i kompressorrum.

Lås

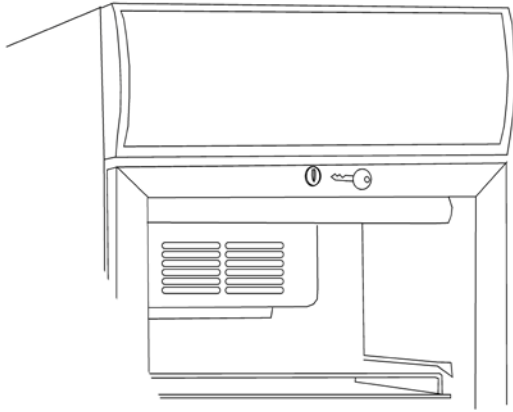

Skabe med hængslede døre er forsynet med en lås, denne er placeret øverst i døren.

Lys

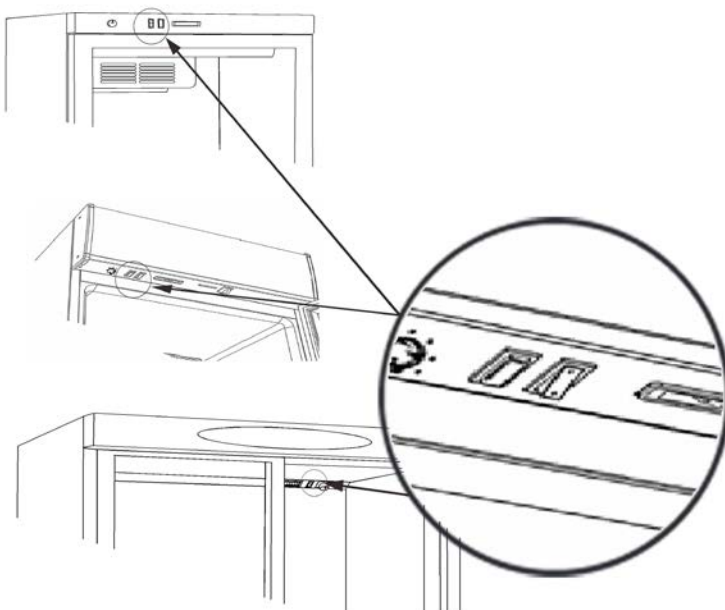

Skabe med lys har en lysafbryder, der alt efter model være placeret:

1. I toppanel
2. Under canopy.
3. I afdækning af intern ventilator.

Udskiftning af lys



HUSK, at afbryde strømforsyningen til skabet inden lyskilder udskiftes !

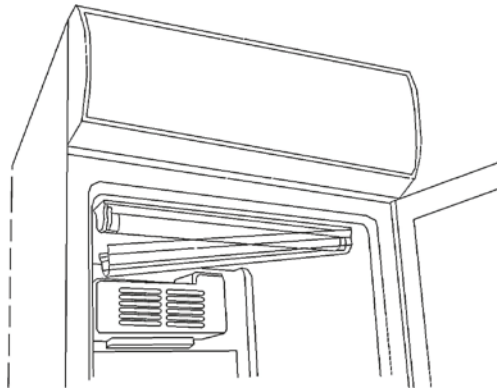

Intern lys:

Det interne neon lys udskiftes ved at afmontere afdækningen og udskifte røret med en tilsvarende type.

Det interne LED lys skal erstattes med en tilsvarende type, kontakt deres lokale leverandør for originale reservedele!

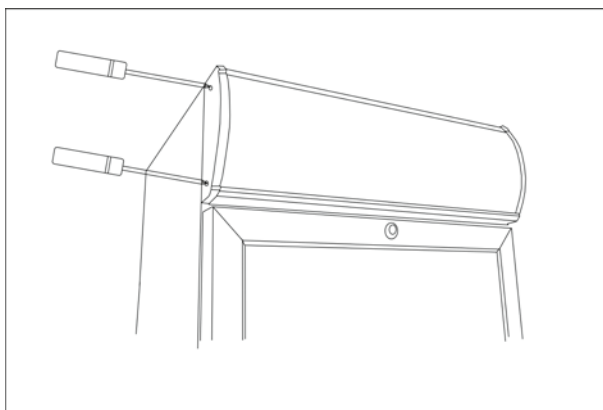

Canopy lys:

Det eksterne neon lys i canopy udskiftes ved at afmontere et sidestykke. Herefter kan lyspladen trækkes til siden for adgang til neonrør. Dette udskiftes med en tilsvarende type.

Det eksterne LED lys i canopy udskiftes på samme måde. Kontakt deres leverandør for originale reservedele!

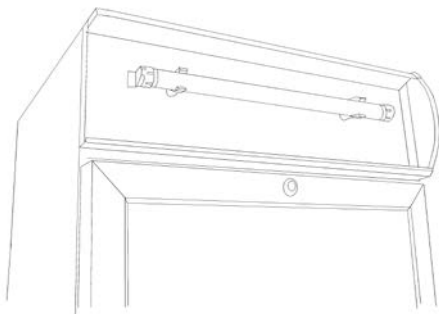

Lyspladen skubbes forsigtigt på plads igen, hvorefter sidestykket genmonteres.

Vending af dør

Visse modeller har vendbare døre. Følg nedenstående instruktioner for at vende hængsling fra højre til venstre og vise versa.

Denne operation foretages lettest ved at ligge skabet forsigtigt ned på bagsiden, evt. på en sækkevogn.

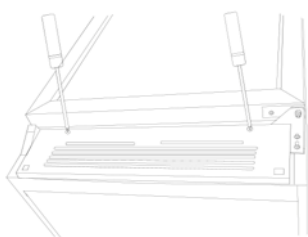

1. Bundpanel afmonteres.

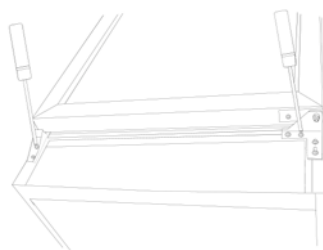

2. Bundhængsel og støtte beslag afmonteres.

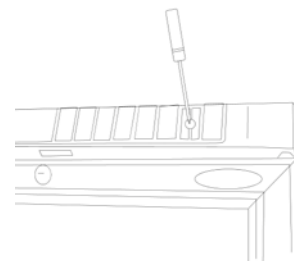

3. Toppanel/Canopy afmonteres.

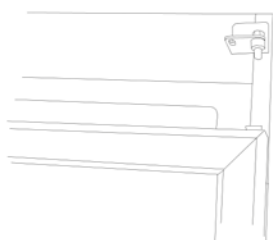

4. Døren løftes, og trækkes ca. 10 cm. ned.

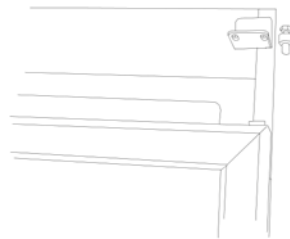

5. Tophængsel-tap afmonteres.

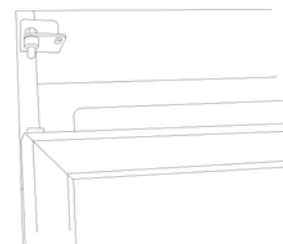

6. Hængsel-tappen monteres i den modsatte side, uden at denne spændes.

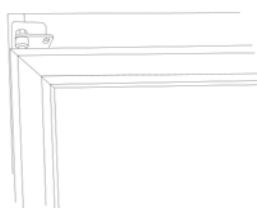

7. Døren løftes op på plads i tophængselet.



8. Tophængsel-tappen spændes.



9. Bundhængsel-tappen afmonteres, og bundhængslet vendes 90 grader.



10. Bundhængsel-tappen gen-monteres på det vendte bundhængsel.

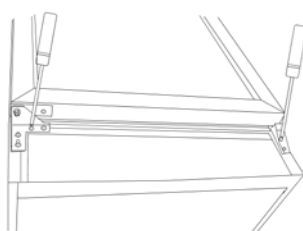

11. Montér bundhængsel og støtte beslag i den nye side.

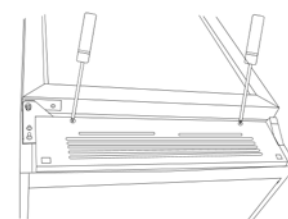

12. Bundpanelet monteres igen.

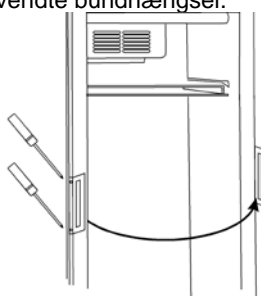

13. Håndtaget flyttes til modsat hængsel-side.

Vægbeslag

Visse modeller er forberedt for ophængning på væg. Se nedenfor.

	A	Max. belastning:
FS60CP	345	20 kg.
FS80CP	360	30 kg.
FSC100	527	30 kg.

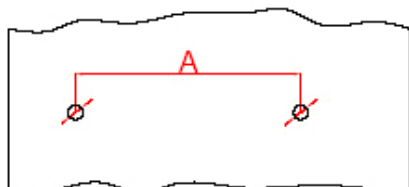

Bor 2 huller med en diameter på 8 mm. og en dybde på 40 mm.
Med den angivne afstand A.

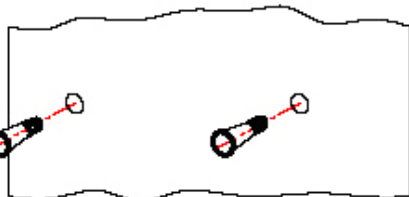

Indsæt 8 mm. plugs.

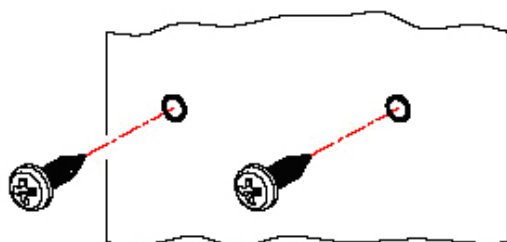

Brug 4,8 x 38 mm. skruer, DIN NO:7981.

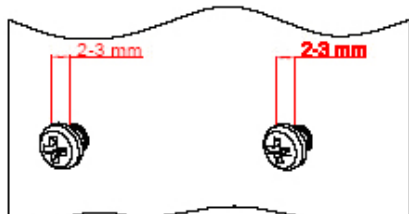

Sørg for at afstanden mellem skruenhoved og væg er 2-3 mm.



Sørg for at skruerne passer perfekt i ophængnings beslaget.

Vedligeholdelse

Skabet har et lukket kølesystem der normalt ikke kræver vedligeholdelse.



HUSK, at afbryde strømforsyningen til skabet inden rengøring foretages !

Det anbefales dog at kondensatoren rengøres 2-4 gange årligt, da det har indflydelse på skabets energiforbrug og de tekniske deles levetid.

Dette gøres bedst med en støvsuger med et børste-mundstykke.

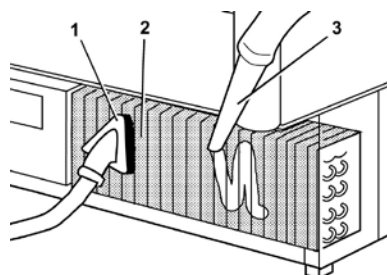
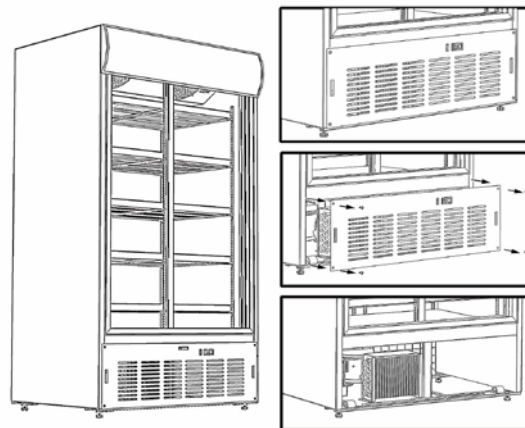
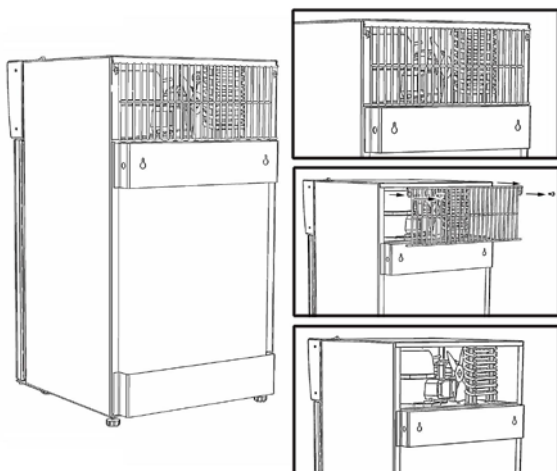
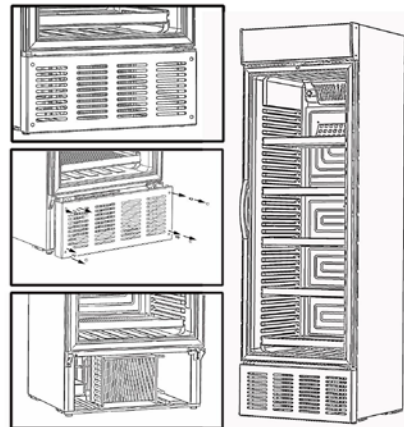
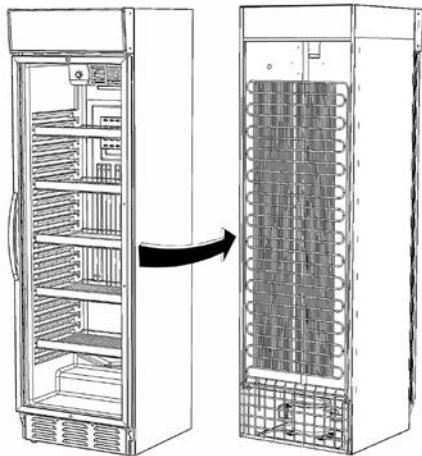

Service

Ved svigt i kølesystemet, undersøg først om det skyldes svigt i elforsyningen.

Kan grunden til svigt ikke findes, må De henvende Dem til Deres leverandør.
Ved al henvendelse bedes De oplyse skabets typenavn og serienummer.
Disse oplysninger findes på typenummerskiltet, typisk placeret inden i skabets højre side.

Brug altid autoriserede reparatører og originale reservedele.



*Dette apparat overholder følgende EU Direktiver:
98/37/EC
89/336/EEC
73/23/EEC.*

Bortskaffelse

Når det udtjente kølemøbel skal bortskaffes, skal det ske på en miljømæssig forsvarlig måde.
Vær opmærksom på særlige nationale regler for bortskaffelse.



Viktiga anvisningar:

De apparater som nämns i det här dokumentet är endast avsedda för förvaring och kylning av drycker i flaskor och burkar.

- Läs bruksanvisningen så att du får mesta möjliga nytta av apparaten.
- Användaren ansvarar för att apparaten används enligt anvisningarna.
- Kontakta återförsäljaren omedelbart i händelse av fel.
- Apparaten är endast avsedd för användning inomhus.
- Apparaten ska placeras i ett torrt rum med god ventilation.
- Apparaten ska inte placeras nära en värmekälla eller i direkt solljus.
- Apparaten ska inte placeras nära ett ventilations- eller luftkonditioneringsystem.
- Observera att alla elektriska apparater kan utgöra en risk.
- Förvara inte ämnen som kan orsaka explosioner i apparaten (gas, bensen, eter eller liknande).
- Varken asbest eller freoner har använts vid tillverkningen av den här apparaten.
- Oljan i kompressorn innehåller inte PCB.



– DEN HÄR APPARATEN MÅSTE ALLTID HA EN JORDAD STICKKONTAKT!
 – VID REPARATION MÅSTE APPARATENS STICKKONTAKT ALLTID DRAS UR OCH APPARATEN MÅSTE VARA STRÖMLÖS!



– ENDAST FÖR APPARATER MED KYLMEDEL R600a!

- Den här apparaten innehåller ett brandfarligt kylmedel, och du måste därför se till att ventilationen är god runt om apparaten.
- Använd aldrig några mekaniska enheter under avfrostning eftersom detta kan orsaka läckage i kylsystemet.
- Använd inte några elektriska apparater inuti kylutrymmet.
- Alla reparationer av apparaten måste utföras av en behörig tekniker (SS-EN 60335-2-89: 2010).

Uppackning och installation:

Ta bort förpackningsmaterialet och kontrollera att skåpet inte har några transportskador.

Alla transportskador måste rapporteras till transportföretaget och noteras på leveranssedeln.

- Vid inbyggnad måste det finnas minst 50 cm utrymme bakom apparaten och ovanför apparaten.
- Kontrollera att luftintaget i den nedre panelen inte är blockerat.
- Placera apparaten plant för att säkerställa korrekt funktion. Du kan ställa in nivån med de ställbara fötterna:

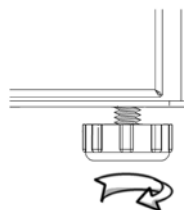

Elektriska anslutningar

Apparaten är avsedd för 220–240 V/50 Hz. Apparaten ska anslutas till ett lätt åtkomligt uttag.

Den här apparaten ska förses med extra skydd i enlighet med gällande elektricitetsbestämmelser. Detta gäller också vid utbyte av en befintlig apparat som inte har extra skydd.

Använd alltid jordade stickkontakter med tre ledare. Kabelledaren med grön/gul isolering ska jordas (märkt ⊕).

I alla övriga fall hänvisas till behörig elektriker som kan informera om hur apparaten ges extra skydd. Om byggnaden saknar extra skydd rekommenderar vi att en elektriker installerar en jordfelsbrytare (PFI eller HPFI).

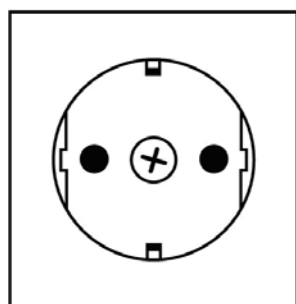

230 V_~ 50 Hz



13 A

Apparaten ska anslutas till ett skyddat uttag på 13 A.

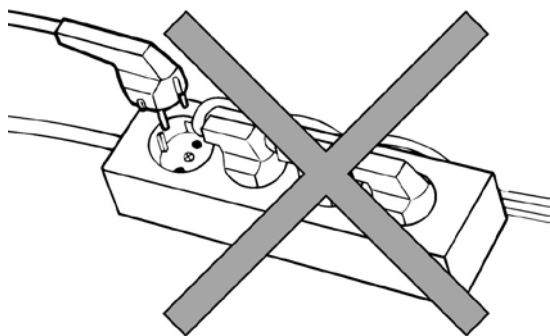

Apparaten får inte anslutas till fördelardosor med flera uttag.

Starta apparaten

Innan du börjar använda apparaten bör du rengöra den – se avsnittet om underhåll.

Viktigt!

Om skåpet har legat ned under transport ska du låta det stå upprätt i två (2) timmar innan du startar det.

Termostat (Se även sidan 90)

Termostatinställningens skala är graderad från 1 till 7, vilket motsvarar ca 2–12 °C. Inställningen 3–4 är optimal i de flesta fall. Kylsystemet kan stängas av vid 0.

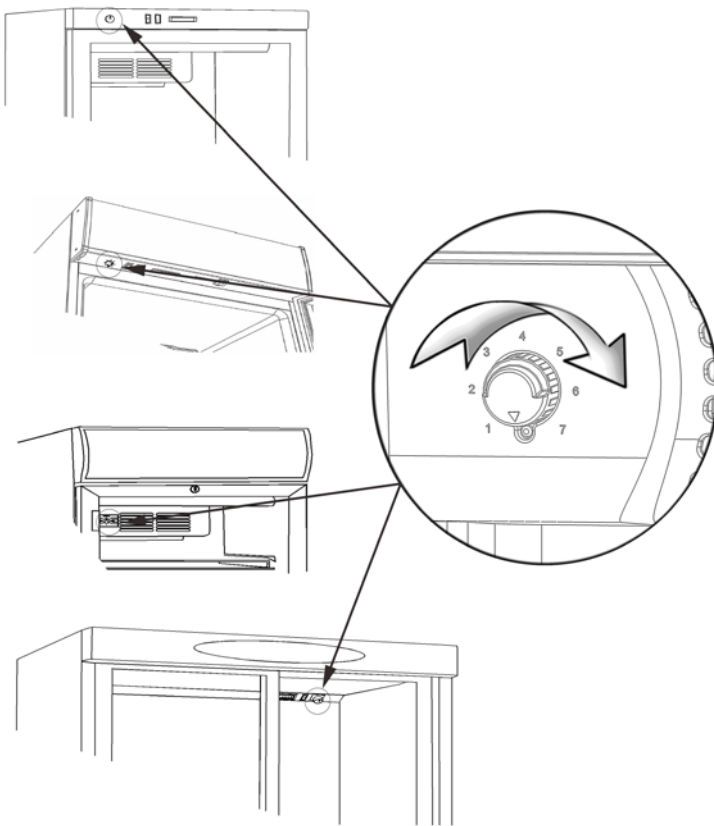

Beroende på modell kan termostaten placeras på följande sätt:

1. På den övre panelen
2. Under skärmdelen
3. På höljet över den interna fläkten

Termometer

Alla apparater har en termometer.

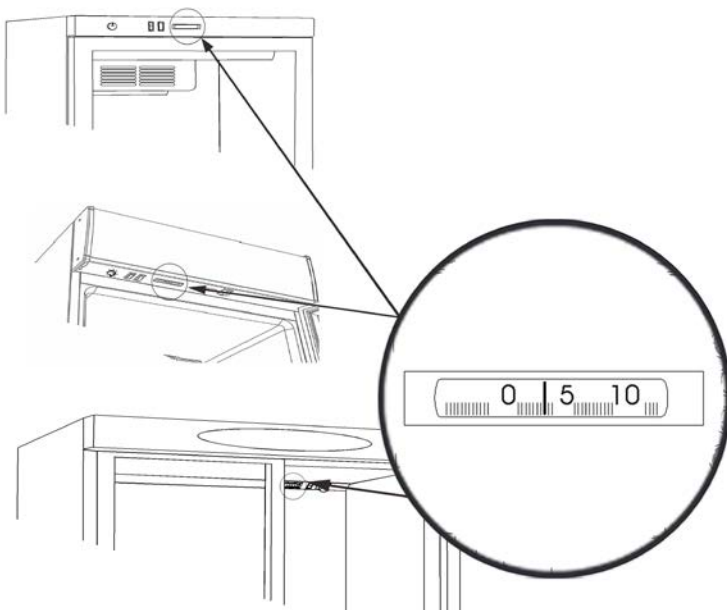

Beroende på modell kan termometern placeras på följande sätt:

1. På den övre panelen
2. Under skärmdelen

Avfrostning

Apparaten har automatisk avfrostning. Utloppsvattnet leds till avdunstning i ett dropptråg i kompressorutrymmet.

Lås

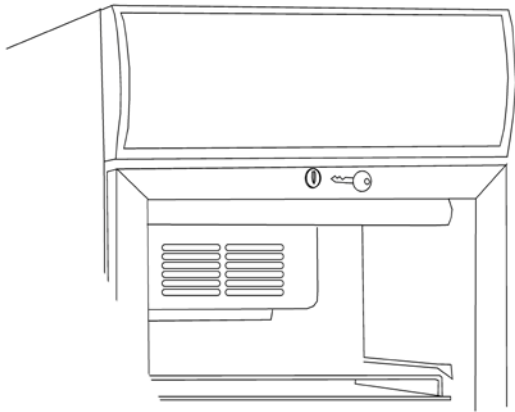

Apparaten med gångjärnsdörr har ett lås. Låset sitter överst i dörren.

Innerlampa

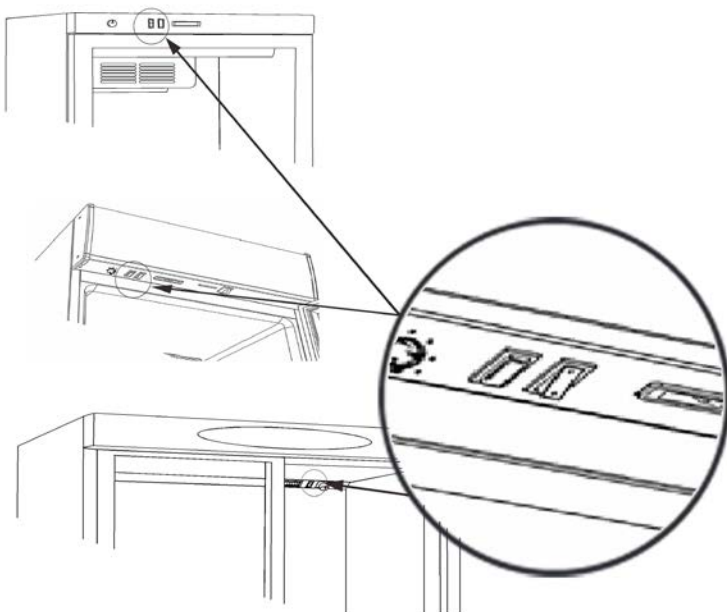

Apparaten med innerlampan har en ljusomkopplare. Beroende på modell är denna placerad enligt följande:

1. På den övre panelen
2. Under skärmdelen
3. På höljet över den interna fläkten

Byta ut lampan



HUSK, at afbryde strømforsyningen til skabet inden lyskilder udskiftes !



Innerlampa:

Du kan byta ut den interna fluorescerande lampan genom att ta bort kåpan över lampan. Byt ut lysröret mot ett nytt av motsvarande typ.

Den interna lysdiodlampan ska bytas ut mot en lampa av motsvarande typ. Kontakta din lokala leverantör för uppgifter om originalreservdelar.

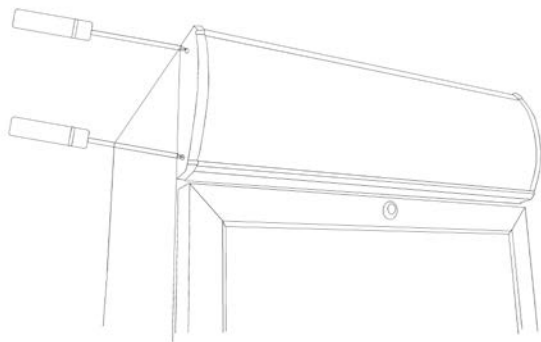

Lampa under skärmdelen:

Den externa fluorescerande lampan i skärmdelen byts ut genom att ta loss skärmdelens ändstycke. Dra skärmdelens skiva åt sidan så att du kommer åt den fluorescerande lampan bakom. Byt ut den mot en ny av samma typ.

Den externa lysdiodlampan i skärmdelen byts ut på samma sätt.

Kontakta din lokala leverantör för uppgifter om originalreservdelar!

Skjut försiktigt in skärmdelen på plats och sätt tillbaka ändstycket.

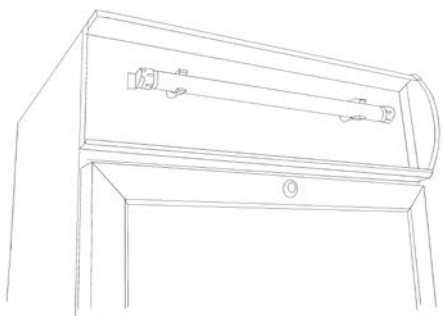

Vända dörren

Vissa modeller har vändbara dörrar. Följ anvisningarna nedan om vändning av dörrarna från höger till vänster och vice versa.

Det här momentet utförs enkelt genom att försiktigt lägga ned skåpet på dess "rygg" eller på en säckkärra.

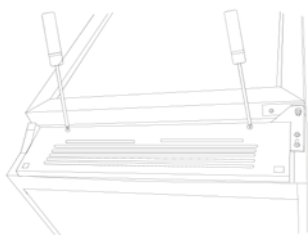

1. Ta bort den nedre panelen.

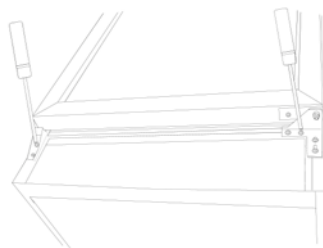

2. Ta bort det nedre gångjärnet och stödbeslaget.

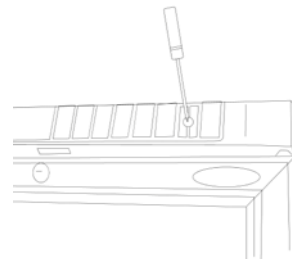

3. Ta bort den övre panelen/skärm delen.

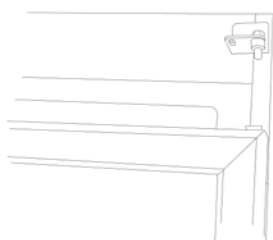

4. Lyft dörren och dra den cirka 10 cm nedåt.

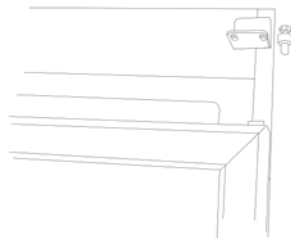

5. Ta bort den övre gångjärnstappen.

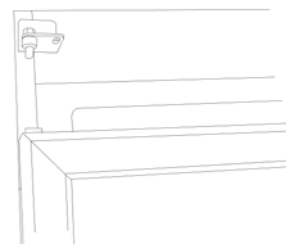

6. Montera gångjärnstappen på motsatta sidan utan att dra åt den.

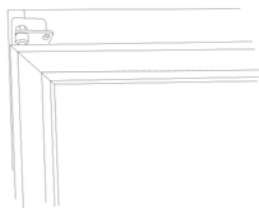

7. Lyft dörren och häng den på det övre gångjärnet.

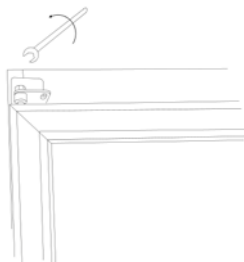

8. Dra åt den övre gångjärnstappen.



9. Ta bort den nedre gångjärnstappen och vrid det nedre gångjärnet 90 grader.



11. Sätt tillbaka den nedre gångjärnstappen vid det nedre gångjärnet som vreds.

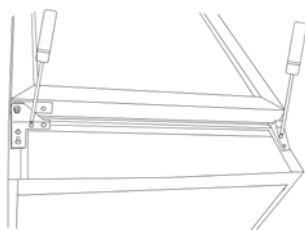

12. Montera det nedre gångjärnet på den motsatta sidan.

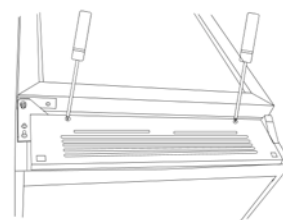

13. Montera den nedre panelen.

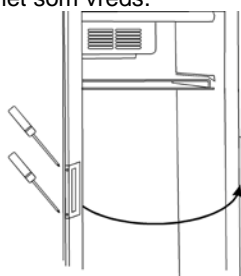

14. Flytta handtaget till den motsatta gångjärnssidan.

Väggfäste

Vissa modeller är förberedda för väggmontering. Se nedan.

	A	Maxlast:
FS60CP	345	20 kg.
FS80CP	360	30 kg.
FSC100	527	30 kg.



Borra två (2) hål med en diameter på 8 mm och ett djup på 40 mm och med avståndet (A) enligt ritningen.

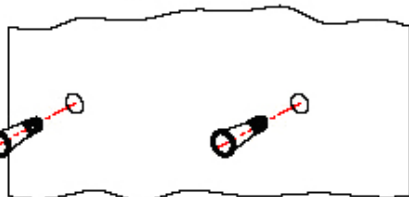

Sätt in 8 mm-pluggar.

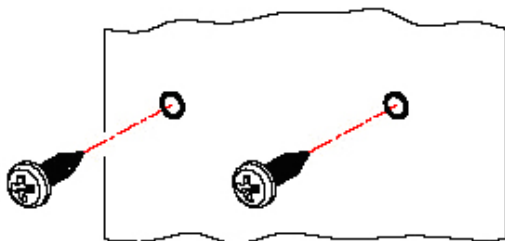

Använd skruvar 4,8 x 38 mm, DIN nr 7981.

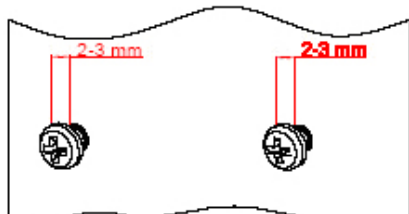

Kontrollera att avståndet mellan skruvhuvudet och väggen är 2–3 mm.

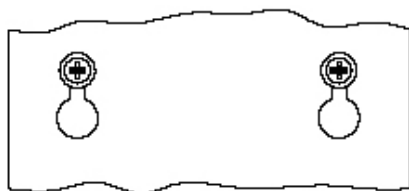

Kontrollera att skruvarna passar perfekt i väggbeslaget.

Underhåll

Apparaten har ett slutet kylsystem som normalt inte kräver något underhåll.



KOM IHÅG att stänga av strömmen innan du rengör apparaten!

Vi rekommenderar rengöring av kondensorn 2–4 gånger om året med en borste eller dammsugare. Detta kan påverka energiförbrukningen och skåpets livslängd.

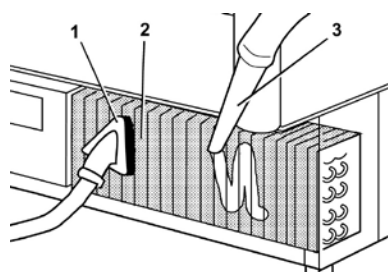
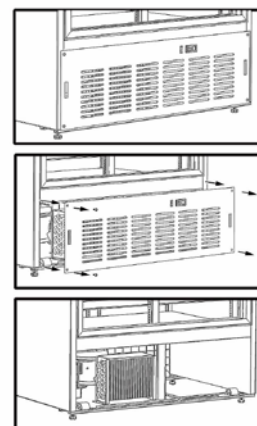
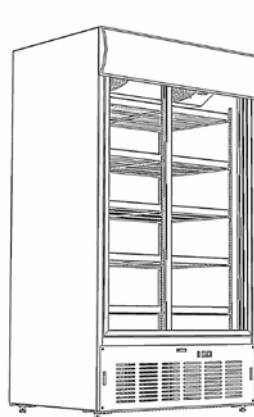
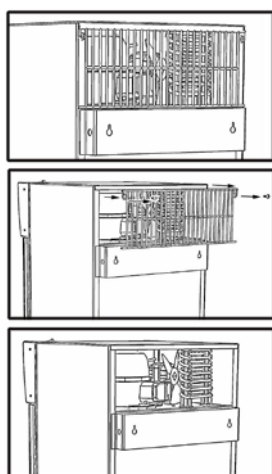
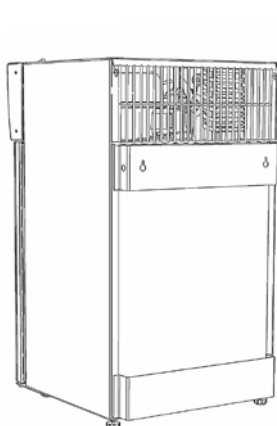
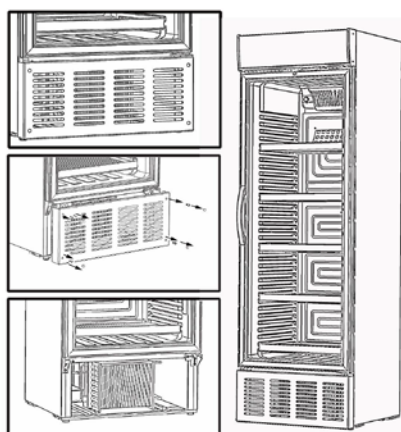
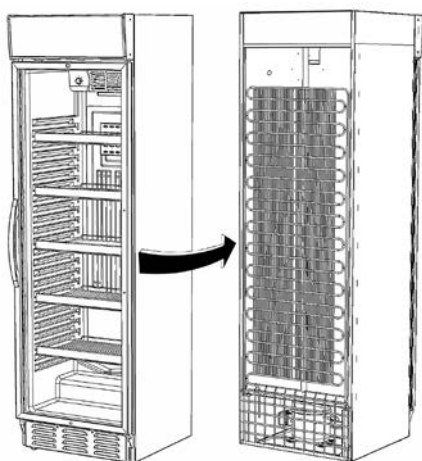

Service

Kontrollera att apparaten har strömförsörjning om den inte kyler som den ska.

Kontakta återförsäljaren om du inte hittar något fel.

När du kontaktar återförsäljaren ska du uppge modellnummer och serienummer – dessa ska placeras på insidan av skåpet på höger sida.

Anlita alltid behöriga tekniker och använd alltid reservdelar.



Den här enheten uppfyller kraven i följande EU-direktiv:

98/37/EG

89/336/EEG

73/23/EEG

Bortskaffande

Gamla förbrukade apparater ska bortskaffas och återvinnas på rätt sätt för att skydda miljön.

Följ de gällande nationella bestämmelserna för bortskaffande av gamla apparater.



Tärkeitä ohjeita:

Tässä oppaassa mainitut laitteet ovat ainoastaan suunniteltu pulloitetun ja tölkitetyn juoman säilytykseen ja jäähdyttämiseen.

- Saadaksesi laitteesta mahdollisimman paljon hyötyjä, lue tämä käyttöohje
- Käyttäjän vastuulla on, että laitetta käytetään, kuten käyttöohjeessa on opastettu.
- Havaittuasi mitä tahansa vikaa laitteen toiminnassa, ole yhteydessä myyjäliikkeeseen.
- Laite on suunniteltu vain sisäkäyttöön.
- Laite tulee sijoittaa kuivaan riittävästi ilmastoituun tilaan.
- Laitetta ei tule sijoittaa lähelle toista lämmönlähdettä, tai suoraan auringonvaloon.
- Laitetta ei tulisi sijoittaa lähelle ilmanvaihtoa tai ilmastointilaitetta.
- Muista, että kaikkiin sähkölaitteisiin liittyy vaara.
- Älä säilytä laitteessa räjähtäviä aineita kuten kaasua, bensiiniä, tai mitään muuta samankaltaisia aineita.
- Laitteen valmistuksessa ei ole käytetty asbestia eikä muitakaan ympäristölle haitallisia CFC-yhdisteitä.
- Kompressorin öljy ei sisällä PCB:tä.



- TÄMÄ LAITE TULEE AINA KYTKEÄ MAADOITETTUUN PISTOKKEeseen!
- HUOLLON YHTEYDESSÄ IRROTA AINA PISTOKE SEINÄSTÄ!



- KOSKEE AINOASTAAN LAITTEITA, JOISSA KÄYTETTY KYLMÄAINETTA R600a!

- Tämä laite sisältää syttyvää kylmäainetta, joten huolehdi riittävästä ilmanvaihdosta laitteen ympärillä.
- Älä käytä mekaanisia työkaluja sulattaessa laitetta. Tämä voi aiheuttaa vuodon kylmäaineputkistossa.
- Älä käytä sähkölaitteita kylmälaitteen jäähdytystiloissa. Do not use electrical appliances inside the refrigerated storage compartment. !??
- Laitteen korjaustoimenpiteet tulee suorittaa pätevän teknisen asiantuntijan toimesta. (EN 60335-2-89: 2010).

Pakkauksesta purkamisen ja asennus:

Poista laite pakkauksestaan ja tarkista, ettei laitteessa ole ulkoisia kuljetusvaurioita.

Kaikki mahdolliset kuljetusvauriot tulee raportoida kuljetusyhtiölle ja ne tulee merkitä vastaanotettaessa rahtikirjaan.

- Mikäli laite integroidaan, varmista, että laitteen taakse sekä yläpuolelle jää vähintään 50cm tuuletustilaa.
- Varmista, että laitteen ilmaotto alaritilältä ei ole estynyt.
- Jotta laite toimisi moitteettomasti, asenna se tasaisesti. Voit asentaa laitteen tasaisesti säätämällä säätäjalkoja:

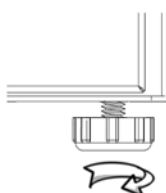

Sähköiset liitännät

Laite toimii 220-240 V/50 Hz verkkovirrassa. Kytke laite lähimpään pistorasiaan.

Laitteelle tulisi olla käytössä lisäsuoja jännitemuutoksia. Laite pitäisi olla lisäsuojaa mukaan vallan määräyksiä. Tämä pätee myös silloin, kun korvaamalla olemassa laite, jolla ei ole ylimääräistä suojaa.

Käytä aina 3 napaista pistoketta.

Kaikissa muissa tapauksissa valtuutettu sähköasentaja voi opastaa kuinka laitteelle on mahdollista saada vikavirtasuojaus. Mikäli rakennuksessa ei ole käytettävissä tällaista lisäsuojaa, Sähköalan liitto suosittelee, että valtuutettu sähköasentaja asentaa laitteelle PDI tai HPFI kytkimen (vikavirtasuojaa).

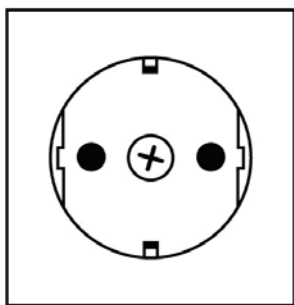

230 V_~ 50 Hz



13 A

Laite tulee liittää 13A sulakkeeseen, maadoitettuun pistorasiaan.

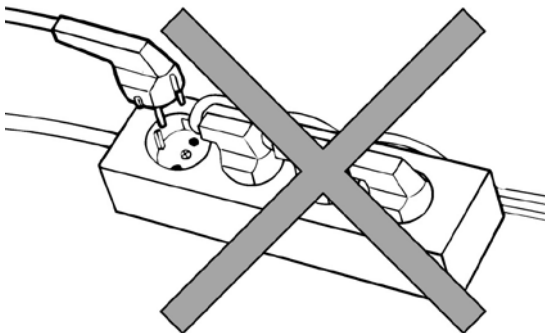

Laitetta ei tule kytkeä jatkojohdon kautta.

Laitteen käynnistäminen

Ennen laitteen käyttöönottoa on suositeltavaa, että se puhdistetaan - katso osio koskien laitteen ylläpitoa.

Tärkeää!

Mikäli laitetta on kuljetettu vaakatasossa kuljetuksen aikana, anna laitteen seistä paikoillaan 2 tunnin ajan ennen päälle kytkemistä.

Termostaatti (Katso myös sivu 90)

Termostaatin säätöasteikko on asteikolla 1-7, vastaten lämpötila-alueetta n. 2-12 °C.

Useimmissa tapauksissa termostaatin optimaalinen säätö on asento 3-4.

Kylmäkone kytkeytyy pois käytöstä termostaatin ollessa asennolla 0.

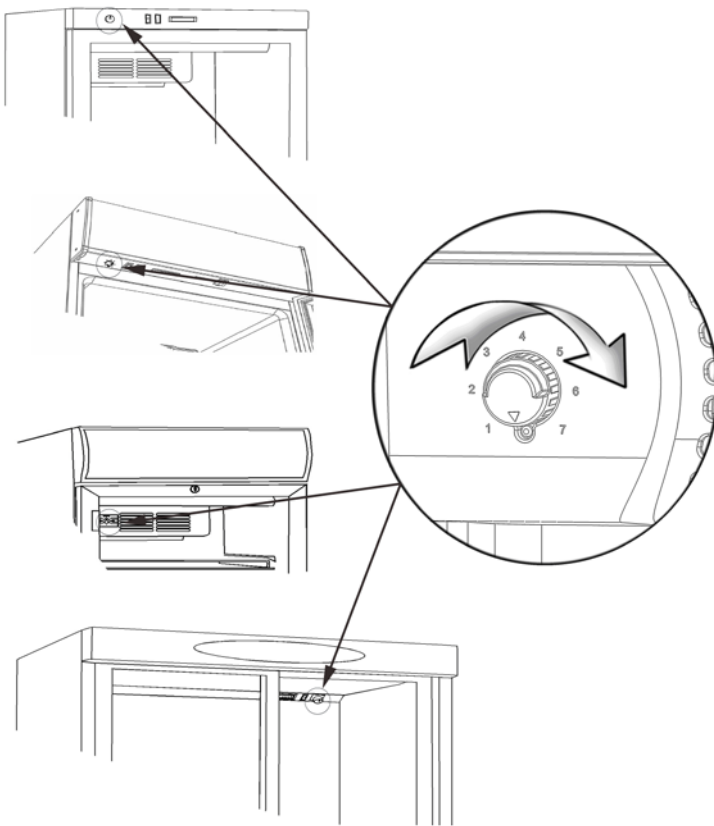

Riippuen mallista, termostaatti voi sijaita seuraavissa paikoissa:

1. Yläpaneelissa
2. Mainosvalokotelon alla
3. Sisäpuhallinkotelon pinnalla

Lämpömittari

Kaikki laitteet on varustettu lämpötilamittarilla.

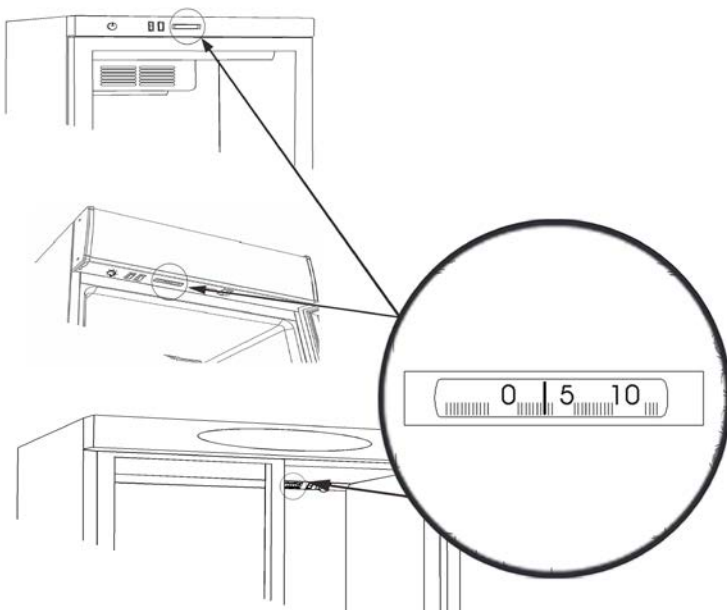

Riippuen mallista, lämpömittari voi sijaita seuraavissa paikoissa:

1. Yläpaneelissa
2. Mainosvalokotelon alla

Sulatus

Laitteessa on automaattinen sulatus. Sulatuksen aikana muodostuva vesi on johdettu kompressorin yläpuolella sijaitsevalle höyrystinvesialtaalle, josta se automaattisesti höyrystyy.

Lukko

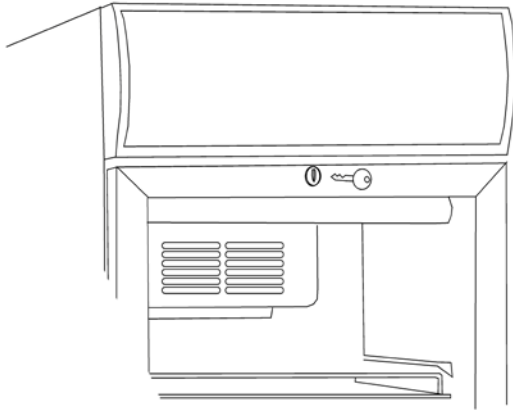

Laitte, mikä on saranovellinen, on varustettu lukolla. Lukko sijaitsee oven karmissa ylhäällä.

Sisävalo

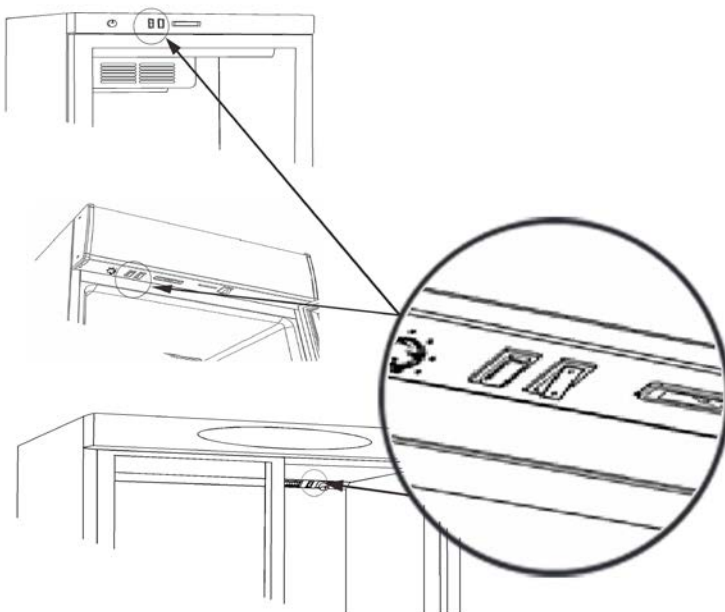

Laitteessa, missä on sisävalo, on myös valokytkin. Riippuen mallista, valokytkin sijaitsee seuraavasti:

1. Yläpaneelissa
2. Mainosvalokotelon alapuolella
3. Sisäpuhallinkotelon pinnalla

Lampun vaihto



MUISTA katkaista laitteesta virta ennen lampun vaihtoa!



Sisävalo:

Sisällä oleva loisteputkivalaisimen vaihto aloitetaan irrottamalla lampun suojus. Korvaa rikkoutunut loisteputki vastaavalla.

Sisällä oleva LED valo tulee korvata samanlaisella valolla. Ole yhteydessä laitteen myyjään tilataksesi alkuperäisen oikean varaosan.

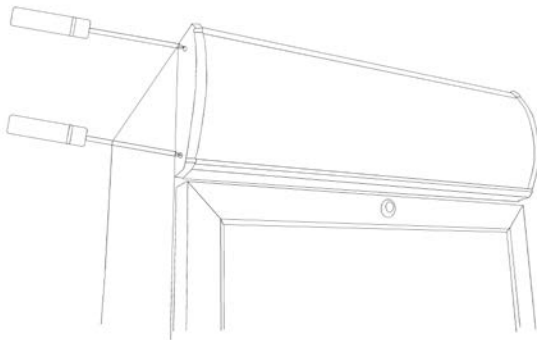

Mainosvalon valo:

Mainosvalokotelon sisällä olevan loisteputken vaihto aloitetaan irrottamalla kotelon päätyosa. Vedä päätyosa irti, jolloin pääset vaihtamaan lampun. Vaihda lamppu vastaavaan.

Mainosvalokotelon sisällä oleva LED valo vaihdetaan samalla tavoin.

Ole yhteydessä paikalliseen toimittajaan tilataksesi alkuperäisiä varaosia!

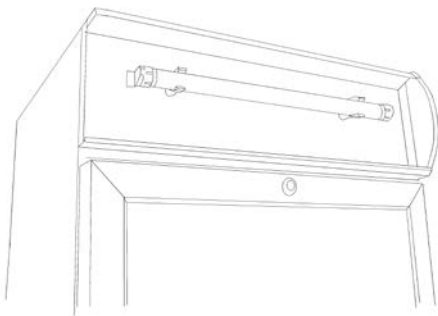

Työnnä mainosvalon pleksi varovasti takaisin paikoilleen ja kiinnitä kotelon päätyosa takaisin paikoilleen.

Oven kätisyyden vaihtaminen

Joissakin malleissa on ovi käännettävissä. Noudata alla olevia ohjeita kätisyyden vaihtamiseksi.

Tämä toimenpide on helppo tehdä nojaamalla laitetta varovasti taaksepäin tai käyttämällä apuna nokkakärkyä.

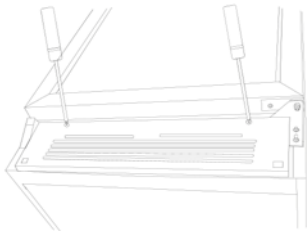

1. Irroita alaritilä.

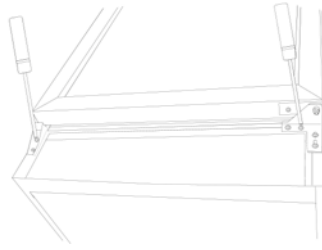

2. Irrota alasarana ja tukipala.

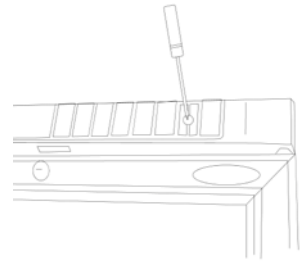

3. Irrota yläpaneeli /
mainosvalokotelo.

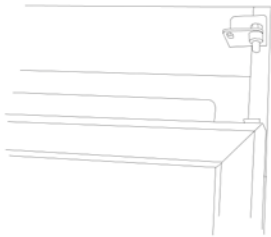

4. Nosta ovi ja vedä se noin 10cm
alaspäin.

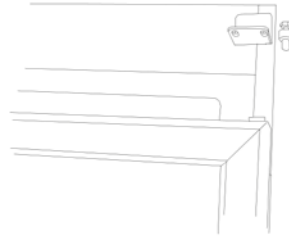

5. Irrota yläsaranan tappi.

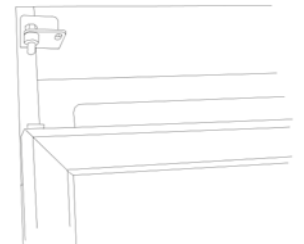

6. Sovita saranatappi vastakkaiselle
puolelle kiristämättä sitä.

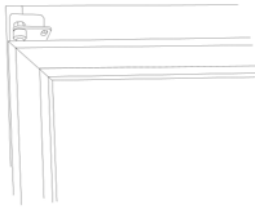

7. Nosta ovi paikoilleen saranatappiin.

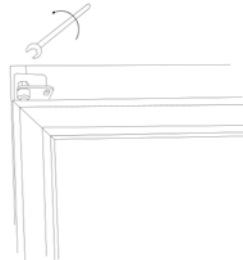

8. Kiristä yläsaranan tappi.

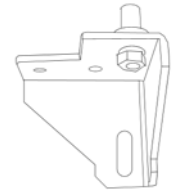

9. Irrota alasaranan tappi ja käännä
alasaranaa 90 astetta.



10. Sovita alasaranan tappi uudelleen
paikoilleen alasaranaan joka on
käännetty.

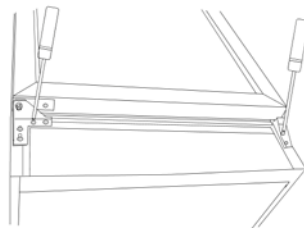

11. Kiinnitä alasarana vastakkaiselle
puolelle.

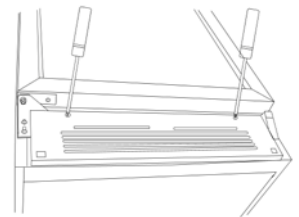

12. Kiinnitä tukipala vastakkaiselle
puolelle.

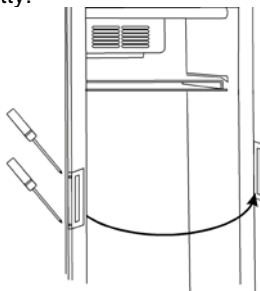

13. Siirrä oven vedin vastakkaiselle
puolelle.

Seinäkiinnitys

Jotkin mallit on suunniteltu seinälle kiinnitettäväksi. Katso alla.

	A	Max. paino:
FS60CP	345	20 kg.
FS80CP	360	30 kg.
FSC100	527	30 kg.

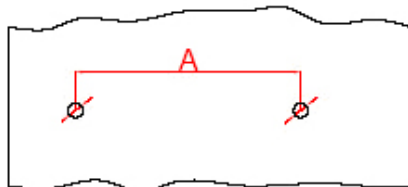

Poraa 2 reikää, halkaisijaltaan 8mm ja syvyydeltään 4mm, joiden etäisyys toisistaan on kuten kerrottu kuvassa (A).

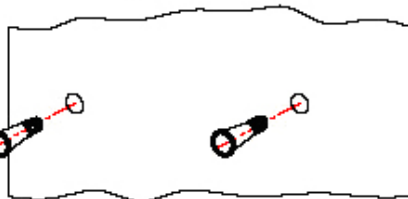

Aseta 8mm tulpat.

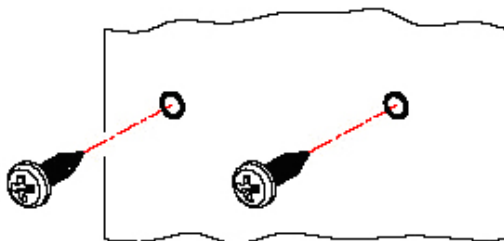

Käytä 4.8 x 38 mm ruuveja, DIN NRO.7981.

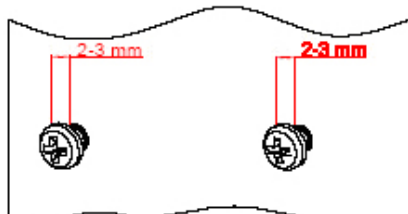

Varmista, että ruuvien pään ja seinän välinen etäisyys on 2-3 mm.

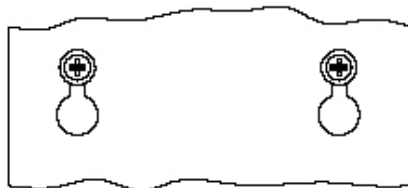

Varmista, että käytetyt ruuvit soveltuvat seinäkiinnitykseen.

Ylläpito

Laite on suljettu jäähdytysjärjestelmä, joka normaalisti ei tarvitse huoltoa.



MUISTA kytkeä laitteesta virta pois ennen puhdistusta!

On kuitenkin suositeltavaa, että lauhdutin puhdistettaisiin 2-4 kertaa vuodessa harjalla tai imurilla. Tämä voi vaikuttaa laitteen toimintaan parantaen energiatehokkuutta ja nostamalla käyttöikää.

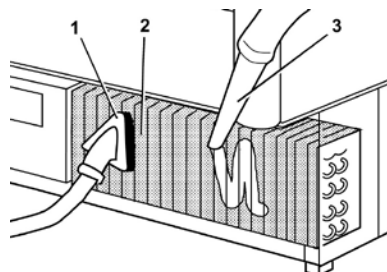
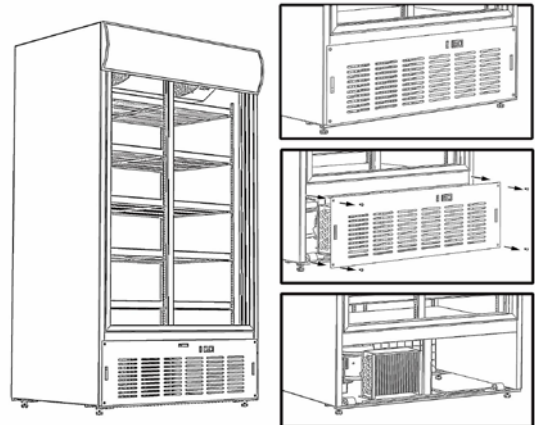
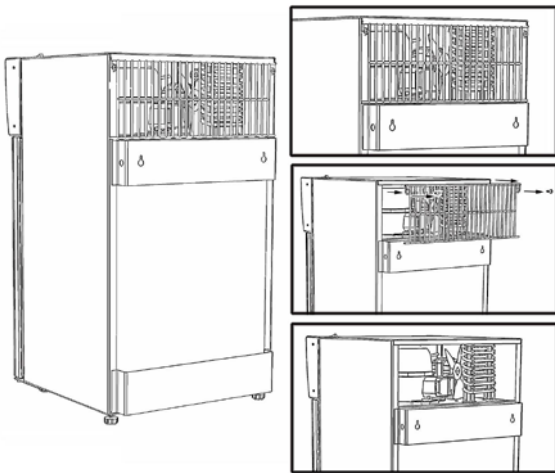
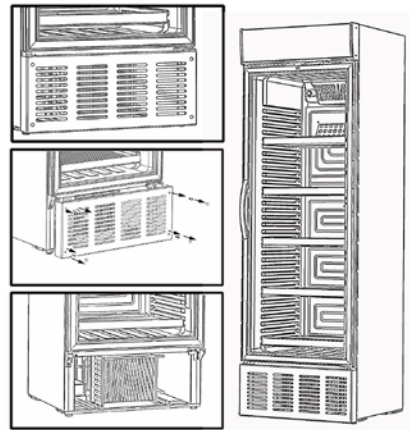
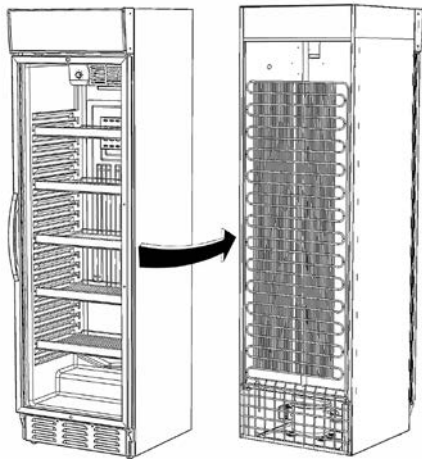

Huolto

Mikäli laite ei tee kylmää, tarkista tuleeko laitteelle virtaa.

Mikäli et löydä vian aiheuttajaa, ota yhteyttä myyntiliikkeeseen. Tässä yhteydessä sinun tulee ilmoittaa myyjälle laitteen malli ja sarjanumero, jotka normaalisti löytyvät laitteen sisällä olevasta tuotekilvestä, oikealla ylhäällä.

Käytä aina korjauksissa valtuutettua huoltoliikettä ja alkuperäisiä varaosia.



*Tämä laite noudattaa seuraavia EU-direktiivejä:
98/37/EC
89/336/EEC
73/23/EEC*

Hävittäminen

Ympäristön suojelemiseksi laitteiden hävittäminen tulisi tehdä lain edellyttämällä tavalla. Huomioi kansalliset määräykset koskien vanhojen kylmälaitteiden hävittämistä.



Important Instructions:

The appliances mentioned in this document are only intended for preservation and cooling of beverages in bottles and cans.

- Read the manual in order to obtain full benefit of the appliance.
- It is the user's responsibility to utilize the appliance according to the instructions.
- Contact the dealer immediately in case of any defects.
- The appliance is only for indoor use.
- The appliance should be placed in a dry sufficiently ventilated room.
- The appliance should not be placed near a source of heat or direct sunlight.
- The appliance should not be placed near a ventilation or air condition system.
- Note that all electrical appliances can cause danger.
- Do not store explosives such as gas, petrol, ether or similar substances in the appliance.
- Asbestos nor CFC have been used in the production of the appliance.
- The oil in the compressor does not contain PCB.



- THIS APPLIANCE MUST ALWAYS HAVE AN EARTHED PLUG!
- AT REPAIR ALWAYS UNPLUG THE APPLIANCE!



- ONLY FOR APPLIANCES WITH REFRIGERANT R600a!

- This appliance contains a flammable refrigerant, so make sure of good ventilation around the appliance.
- Do not use mechanical devices when defrosting, this can cause leakage of the cooling system.
- Do not use electrical appliances inside the refrigerated storage compartment.
- Any repair of the appliance should be carried out by a skilled technician (EN 60335-2-89: 2010).

Unpacking and Installation:

Remove the packing and check that the cabinet has no transport damage.

Any transport damages should be reported to the transport company and noted on the delivery note.

- When building-in ensure a distance of at least 50 cm behind the appliance and above the appliance.
- Make sure that the air intake at the bottom panel is not blocked.
- Place the appliance in a level position for correct functioning. This can be achieved by adjusting the adjustable feet:

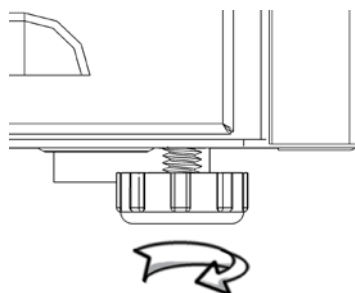

Electrical Connections

The appliance is intended for 220-240 V/50 Hz. The connection should be effected to an accessible socket.

This appliance should have extra protection according to the power regulations. This is also the case when replacing an existing appliance which does not have the extra protection.

Always use a 3 pin plug. The lead with green/yellow insulation should be earthed (marked \oplus).

In all other cases an authorized electrician can tell you how to get the extra protection of the appliance. In case there is no extra protection in the building, the Board of Electricity recommends that an electrician installs a PFI or HPFI switch (contact breaker).

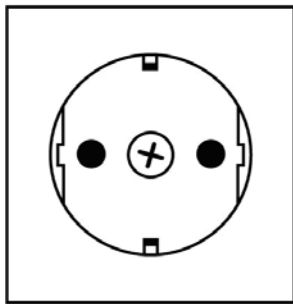

230 V_~ 50 Hz



13 A

The appliance should be connected to an 13A protected socket.

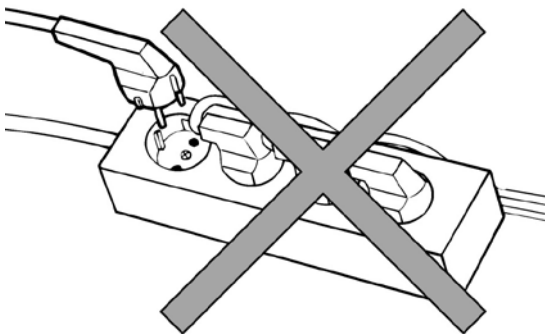

The appliance should not be connected to a multipoled distribution socket.

Start-up the Appliance

Before taking the appliance into use it is recommended to clean it – see section regarding maintenance.

Important!

In case the cabinet has been lying down during transport leave it standing up for 2 hours before switching it on.

Thermostat (Also see page 90)

The thermostat setting has a scale 1-7, corresponding to approx. 2-12 °C.
In most cases a setting of 3-4 will be optimum.
The cooling system can be switched off at 0.

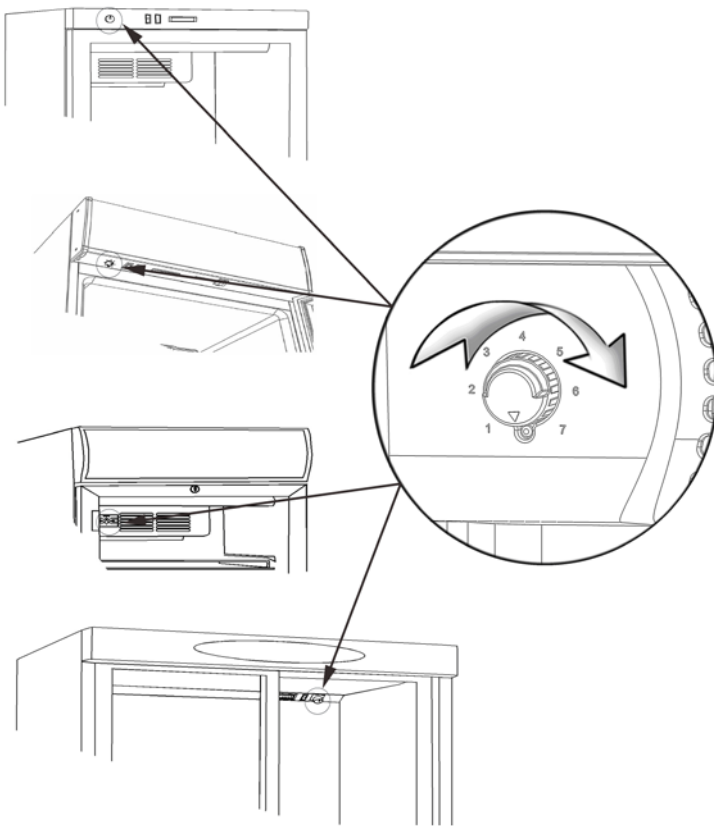

Depending on model the thermostat can be placed as follows:

1. In top panel
2. Under the canopy
3. On the cover of the internal fan

Thermometer

All appliances are fitted with a thermometer.

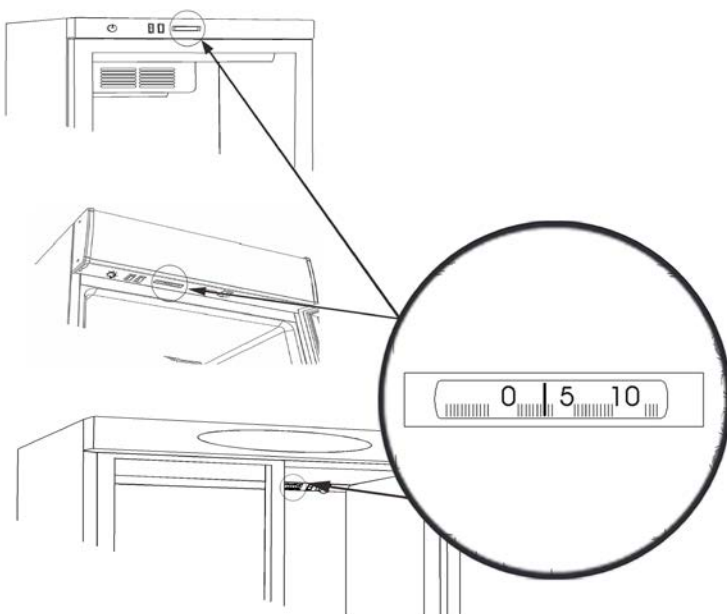

Depending on model the thermometer can be placed as follows:

1. In top panel
2. Under the canopy

Defrosting

The appliance has automatic defrost. Discharge water is led to evaporation in a drip tray placed in the compressor compartment.

Lock

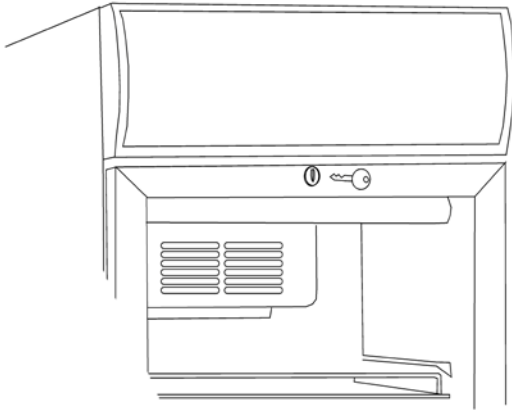

The appliance with hinged door has a lock. The lock is placed at the top of the door.

Internal Light

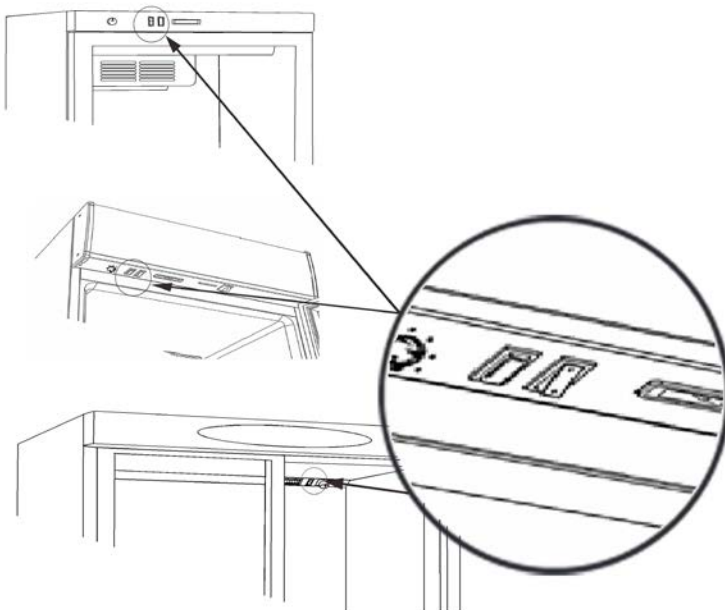

Appliance with internal light has a light switch. Depending on model this is placed as follows:

1. In the top panel
2. Under the canopy
3. On the cover of the internal fan

Replacing the Light



REMEMBER to switch off the power before replacing the light!



Internal Light:

The internal fluorescent light is replaced by demounting the light cover. Replace the tube with an equivalent type.

The internal LED light should be replaced by an equivalent type. Contact your local supplier for original spare parts.

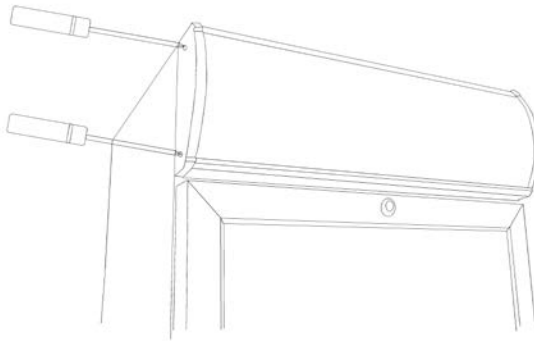

Canopy Light:

The external fluorescent light in the canopy is replaced by dismounting the end piece of the canopy. Pull the canopy plate to one side giving access to the fluorescent light. Replace it with an equivalent type.

The external LED light in the canopy is replaced in the same way.

Contact your local supplier for original spare parts.

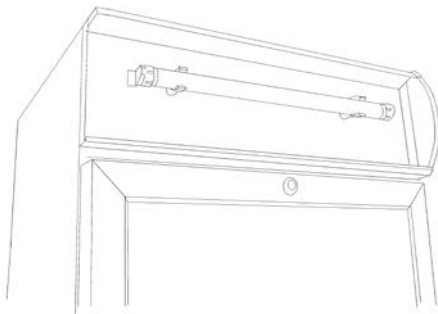

Push carefully the canopy plate in place and remount the end piece of the canopy.

Door Reversal

Some models have reversible doors. Follow the below mentioned instructions for door reversal from right to left and vice versa.

This operation is easily done by carefully lying down the cabinet at its back or on a sack truck.

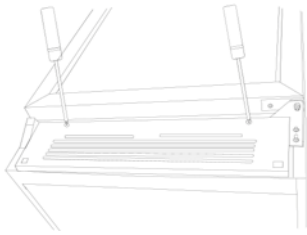

1. Remove the bottom panel

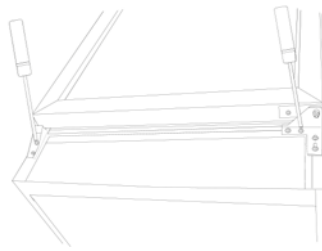

2. Remove the bottom hinge and the support fitting.

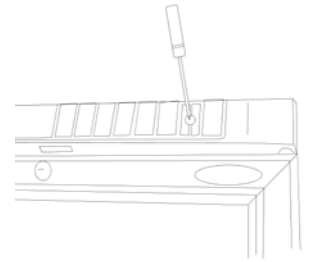

3. Remove the top panel/canopy.

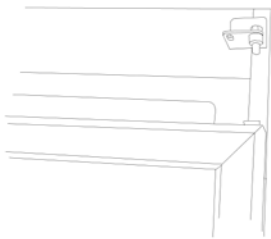

4. Lift the door and pull it approx. 10 cm down.

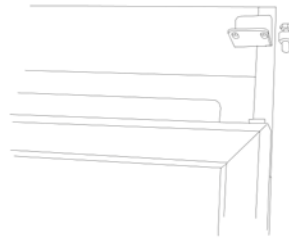

5. Remove the top hinge pin.

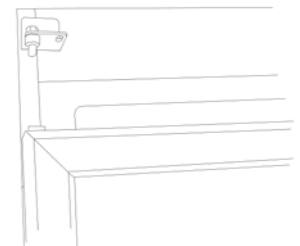

6. Fit the hinge pin at the opposite side without tightening it.

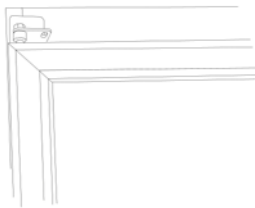

7. Lift the door in place in the top hinge.



8. Tighten the top hinge pin.

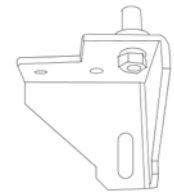

9. Remove the bottom hinge pin and turn the bottom hinge 90 degrees.



10. Refit the bottom hinge pin to the bottom hinge which was turned.

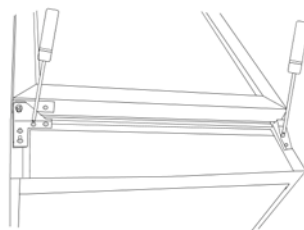

11. Fit the bottom hinge on the opposite side.

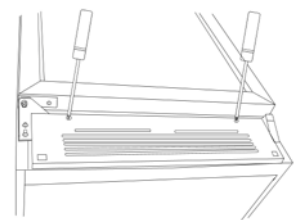

12. Refit the bottom panel.

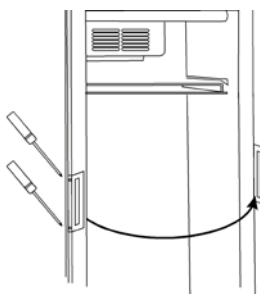

13. Move the handle to the opposite hinge side.

Wall Fitting

Some models are prepared for wall fitting. See below.

	A	Max. Load:
FS60CP	345	20 kgs.
FS80CP	360	30 kgs.
FSC100	527	30 kgs.

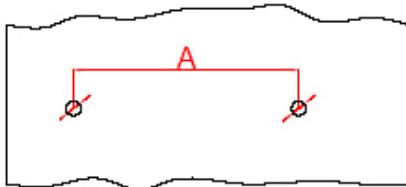

Drill 2 holes with a diameter of 8 mm and a depth of 40 mm and a distance as shown on the drawing (A).

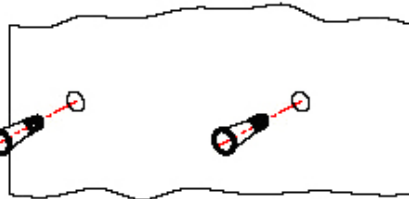

Insert 8 mm plugs.

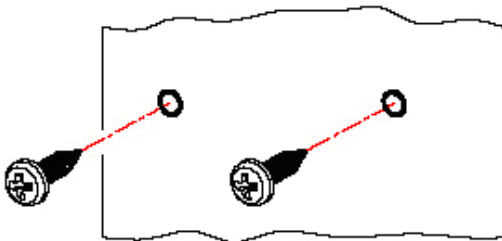

Use 4.8 x 38 mm screws, DIN NO.7981.

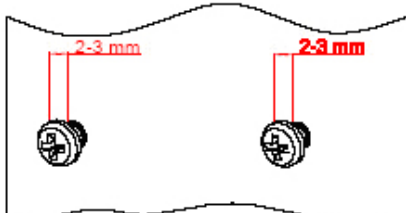

Make sure the distance between the screw head and the wall is 2-3 mm.

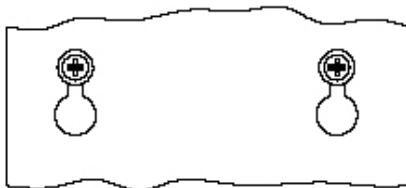

Make sure the screws fit perfectly into the wall fitting.

Maintenance

The appliance has a closed cooling system, which normally does not require any maintenance.



REMEMBER to switch off the power before cleaning the appliance!

However, it is recommended to clean the condenser 2-4 times a year by means of a brush or a vacuum cleaner. This can influence the energy consumption and the lifetime of the cabinet.

The appliance has automatic defrost. Discharge water is led to evaporation in a drip tray placed in the compressor compartment.

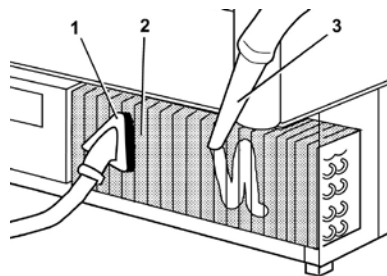
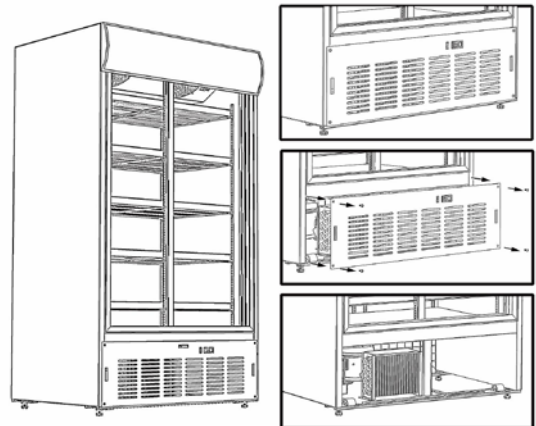
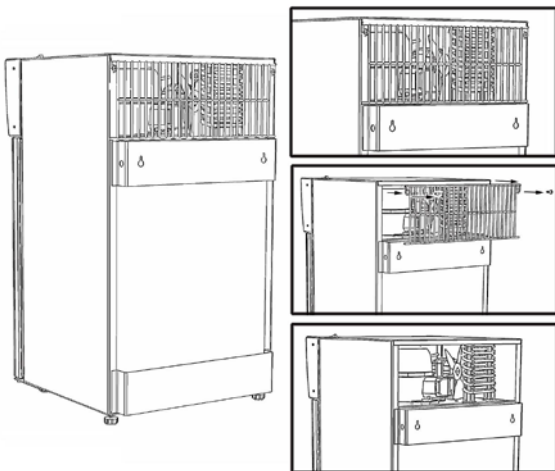
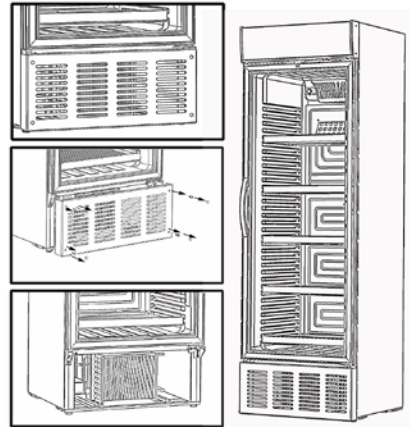
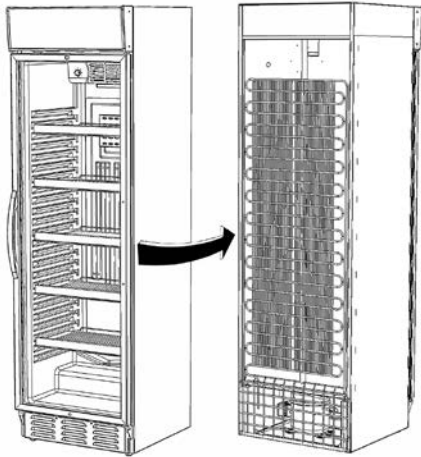

Service

In case of no cooling check failure in the power supply.

In case you are unable to find any failure, please contact your dealer.

You need to inform your dealer of the model number and serial number stated on the rating label normally placed inside on the right side of the cabinet.

Always use authorized technicians and original spare parts.



This device complies with the following EU Directives:

98/37/EC

89/336/EEC

73/23/EEC

Disposal

The disposal of old appliances should be done correctly in order to protect the environment.

Please observe the national regulations for disposal of old appliances.



Wichtige Informationen:

Die in diesem Dokument beschriebenen Kühler sind ausschließlich zur Aufbewahrung und Kühlung von Getränken in Flaschen oder Dosen vorgesehen.

- Lesen Sie diese Bedienungsanleitung durch, um den vollen Nutzen vom Schrank zu erzielen.
- Der Braucher ist für die vorschriftsgemäße Anwendung vom Schrank verantwortlich.
- Kontaktieren Sie bei Fehlern am Schrank sofort den Händler.
- Der Schrank ist nur für die Verwendung in Innenräumen.
- Der Schrank soll in einem trockenen und ausreichend ventilierten Raum angebracht werden.
- Der Schrank soll nicht in der Nähe von Wärmequellen oder in direktem Sonnenlicht platziert werden.
- Der Schrank soll nicht in der Nähe von Ventilations- oder Aircondition-Anlagen platziert werden.
- Achten Sie darauf, dass alle elektrischen Geräte zu Gefahr führen können.
- Bewahren Sie keine explosionsgefährlichen Stoffe, z.B. Gas, Benzin, Äther u.ä. im Schrank auf.
- In der Konstruktion ist kein Asbest oder CFC verwendet worden.
- Das Öl im Kompressor enthält kein PCB.



- DEN SCHRANK IMMER EINEM STECKER MIT ERDUNG ANSCHLIEßEN!
- BEI WARTUNG DEN STECKER IMMER AUS DER STECKDOSE NEHMEN!



- NUR FÜR SCHRÄNKE MIT KÜHLMITTEL R600a!

- Dieser Schrank enthält ein brennbares Kühlmittel, deshalb immer für gute Ventilation um den Schrank sorgen.
- Verwenden Sie für das Abtauen keine mechanischen Werkzeuge, da dies zu Leckagen im Kühlsystem führen kann.
- Keine elektrischen Werkzeuge im Schrank verwenden.
- Jede Reparatur am Schrank muss von einem qualifizierten Techniker ausgeführt werden. (EN 60335-2-89: 2010)

Auspackung und Aufstellung:

Die Verpackung entfernen und das Gerät nach Transportschaden prüfen.
Eventuelle Transportschaden sind unverzüglich dem Spediteur mitzuteilen.

- Beim Einbauen ist hinter und über dem Schrank ein Abstand von mindestens 50 mm zu beachten.
- Sorgen Sie dafür, dass die Lufteinnahme im Bodenpaneel nicht blockiert wird.
- Für die Funktion vom Schrank ist eine gerade Platzierung wichtig. Die Füße können so justiert werden:

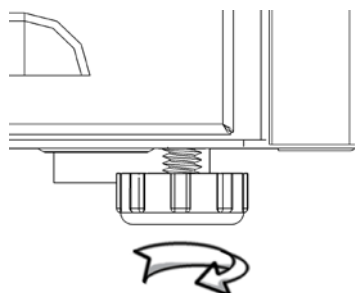

Anschließen

Der Schrank ist für den Anschluß an 220-240 V/50 Hz vorgesehen. Der Anschluß muss durch eine Steckdose gemacht werden, die leicht zugänglich sein soll.

Dieser Kühlmöbel muß gesetzmäßig extra geschützt werden. Dies gilt auch bei der Auswechslung eines existierenden Kühlmöbels, der nicht extra geschützt ist.

In jedem Fall ist ein Drei-Punkte-Stecker zu verwenden, und das Kabel mit grüner/gelber Isolierung muß der Erdungsklemme angeschlossen werden (⊕).

In allen anderen Fällen soll ein autorisierter Elektriker prüfen, wie der Schrank am einfachsten extra geschützt wird. Falls Sie im Gebäude keinen Extraschutz schon haben, empfehlen wir durch einen Elektriker einen PFI- oder HPFI-Schalter installieren zu lassen.

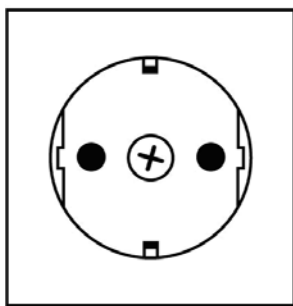

230 V_~ 50 Hz



13 A

Der Schrank muss einem 13 A geschützten Auslauf angeschlossen werden.

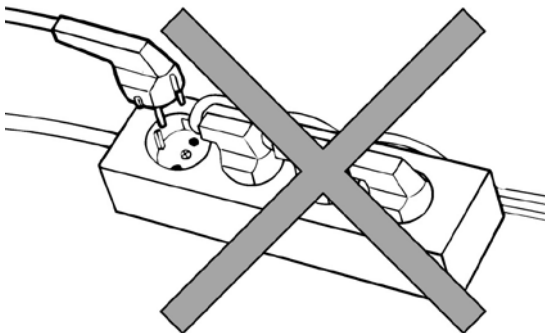

Der Schrank soll nicht einer mehrpoligen Anschlussdose angeschlossen werden.

Starten

Vor Inbetriebnahme soll der Schrank gereinigt werden, sehen Sie den Abschnitt „Wartung“.

Wichtig !

Wenn der Schrank liegend transportiert wurde, warten Sie zwei Stunden mit dem Starten.

Thermostat (Siehe auch Seite 90)

Der Thermostat ist auf einer Skala von 1-7 einstellbar, was ungefähr 2-12 °C entspricht.

Eine Einstellung von 3-4 wird in den meisten Fällen optimal sein.

Das Kühlsystem kann durch die Einstellung auf null abgeschaltet werden.

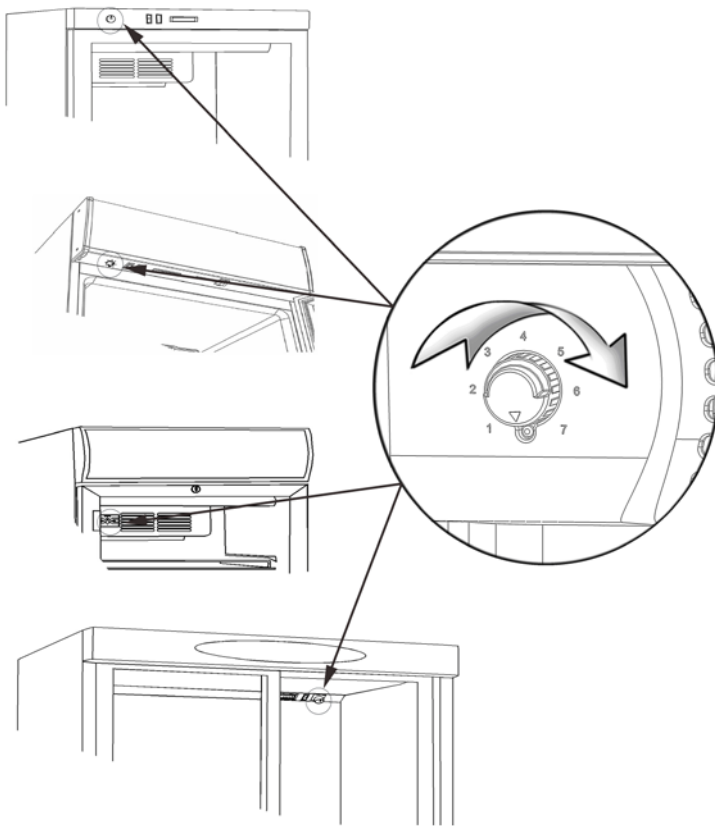

Der Thermostat kann je nach Modell wie folgt platziert sein:

1. Im Toppaneel
2. Unter dem Canopy
3. In der Abdeckung vom Innenlüfter

Thermometer

Alle Schränke sind mit einem Thermometer versehen.

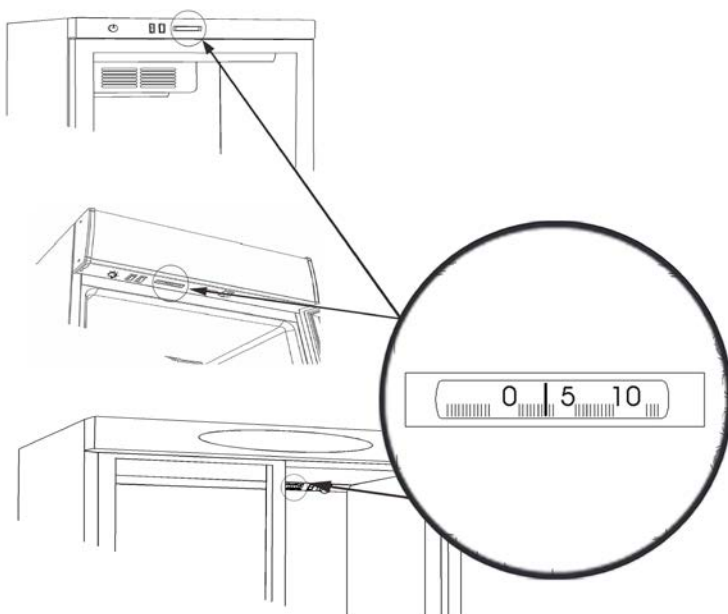

Das Thermometer kann je nach Modell wie folgt platziert sein:

1. Im Toppaneel
2. Unter dem Canopy

Abtauen

Der Schrank taut automatisch ab. Das Tauwasser wird in einen Behälter im Kompressorraum zur Verdampfung geleitet.

Schloß

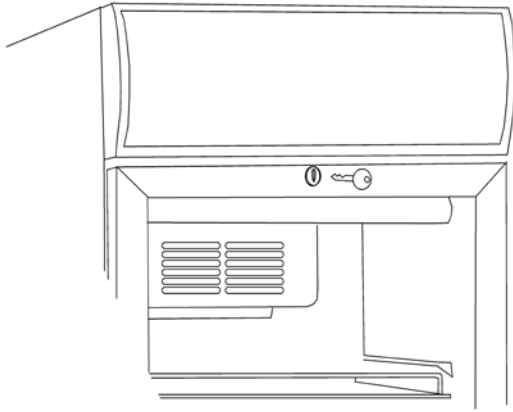

Die Schränke mit Drehtür sind mit einem Schloß versehen, das oben im Türrahmen platziert ist.

Licht

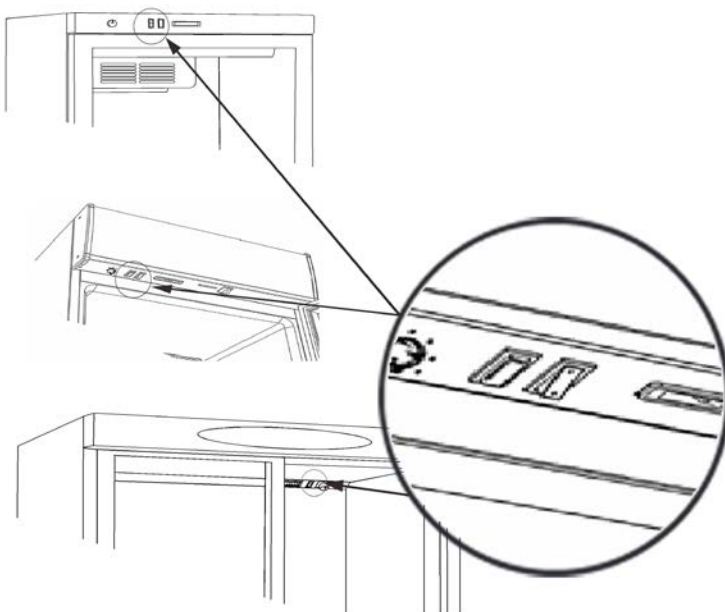

In den Schränken mit Licht kann der Lichtschalter wie folgt platziert sein:

1. Im Toppaneel
2. Unter dem Canopy
3. In der Abdeckung vom Innenlüfter

Auswechslung vom Licht



Achtung! Vor der Auswechslung von Lichtquellen ist die Stromversorgung zum Schrank immer abzubrechen



Innenlicht:

Neon:

Die Abdeckung abmontieren und die Röhre durch ein entsprechendes Typ ersetzen.

LED:

Das LED-Innenlicht ist durch ein entsprechendes Typ zu ersetzen. Kontaktieren Sie Ihren lokalen Lieferanten für originale Ersatzteile.

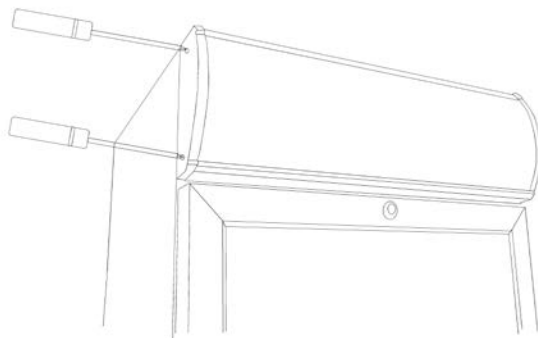

Licht im Canopy:

Neon:

Das eine der beiden Seitenstücke abmontieren. Die Lichtplatte zur Seite ausziehen, um an die Neonröhre zu kommen. Diese durch ein entsprechendes Typ ersetzen.

Das LED-Licht im Canopy lässt sich auf dieselbe Weise auswechseln.

Kontaktieren Sie Ihren Lieferanten für originale Ersatzteile.

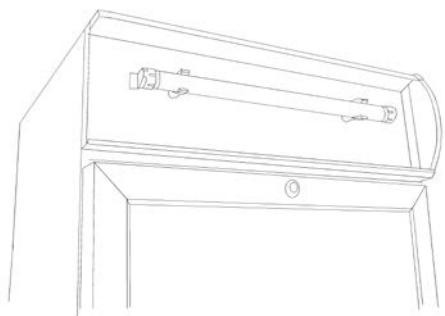

Die Lichtplatte danach vorsichtig auf ihren Platz zurückschieben und das Seitenstück wieder montieren.

Wechsel vom Türanschlag

Gewisse Modelle haben wechselbare Türanschläge. Folgen Sie den unten Anweisungen, um den Türanschlag von rechts auf links zu wechseln und umgekehrt.

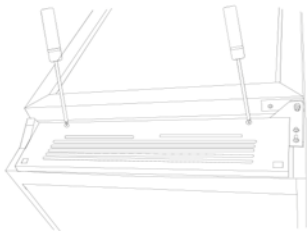

1. Das Bodenpaneel abmontieren.

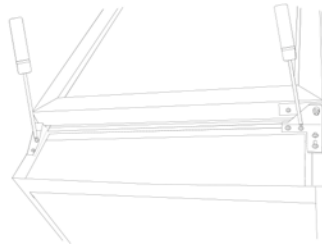

2. Bodenscharnier und Stützbeschlag abmontieren.

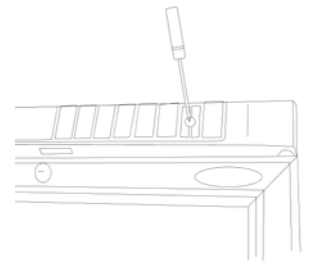

3. Toppaneel abmontieren.

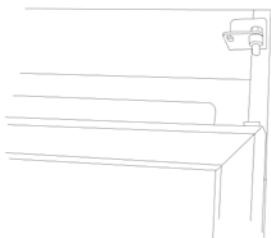

4. Die Tür heben und etwa 10 cm nach unten ziehen.

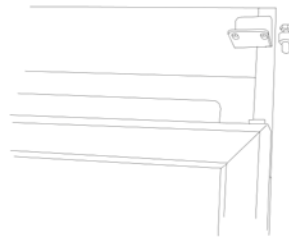

5. Scharnierstift oben abmontieren.

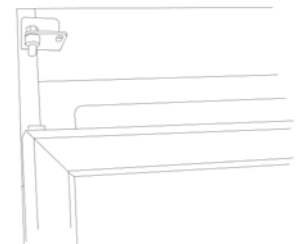

6. Den Scharnierstift in der anderen Seite montieren, aber nicht spannen.

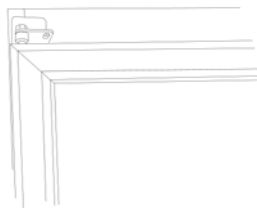

7. Die Tür heben und im oberen Scharnier einsetzen.



8. Den Stift vom oberen Scharnier spannen.

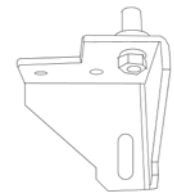

9. Den Stift vom unteren Scharnier abmontieren und das untere Scharnier 90 Grad drehen.



10. Den Stift vom unteren Scharnier wieder auf dem gedrehten Scharnier montieren.

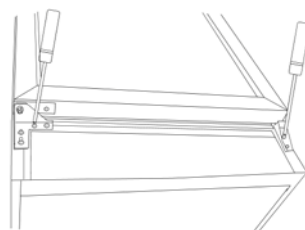

11. Das untere Scharnier und den Stützbeschlag in der neuen Seite montieren.

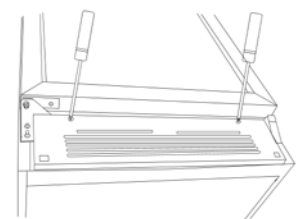

12. Das Bodenpaneel wieder montieren.

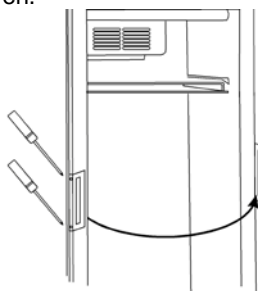

13. Den Griff auf die andere Seite montieren.

Wandbeschlag

Gewisse Modelle sind für Montage an der Wand vorgesehen. Sehen Sie unten.

	A	Max. Belastung:
FS60CP	345	20 kg.
FS80CP	360	30 kg.
FSC100	527	30 kg.

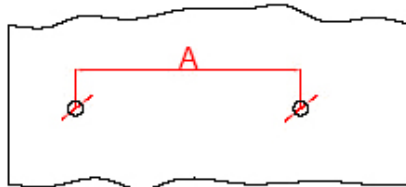

Bohren Sie zwei Löcher mit einem Durchmesser von 8 mm und einer Tiefe von 40 mm, mit dem angegebenen Abstand A.

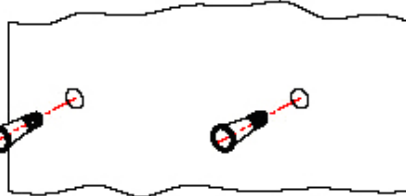

Setzen Sie 8 mm Dübel ein.

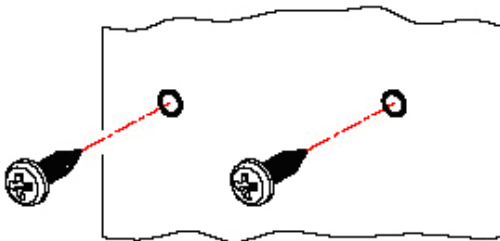

Verwenden Sie 4,8 x 38 mm. Schrauben, DIN NO:7981.

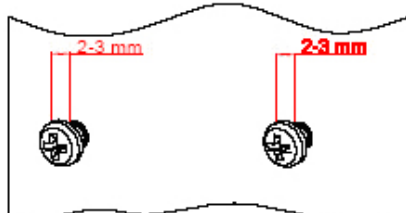

Sorgen Sie für einen Abstand von 2-3 mm zwischen Wand und Schraubenkopf.

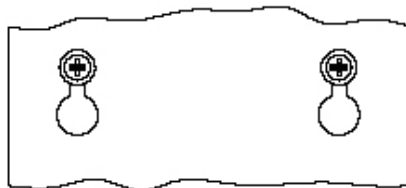

Sorgen Sie dafür, dass die Schrauben perfekt in den Beschlag passen.

Wartung

Der Schrank hat ein geschlossenes Kühlsystem, das normalerweise keine Wartung fordert.



ACHTUNG! Vor Reinigung immer die Stromversorgung zum Schrank abbrechen!

Wir empfehlen, den Kondensator 2 bis 4 Mal im Jahr zu reinigen, um den Energieverbrauch zu reduzieren und die Lebenszeit der technischen Teile zu verlängern.

Dies lässt sich am besten mit einem Staubsauger mit Bürste-Mundstück machen.

Der Schrank taut automatisch ab. Das Tauwasser wird in einen Behälter im Kompressorraum zur Verdampfung ausgeleitet.

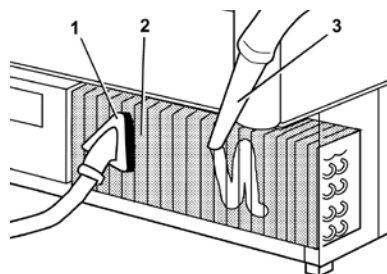
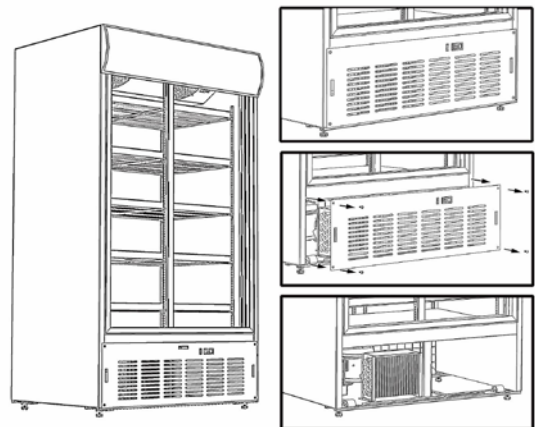
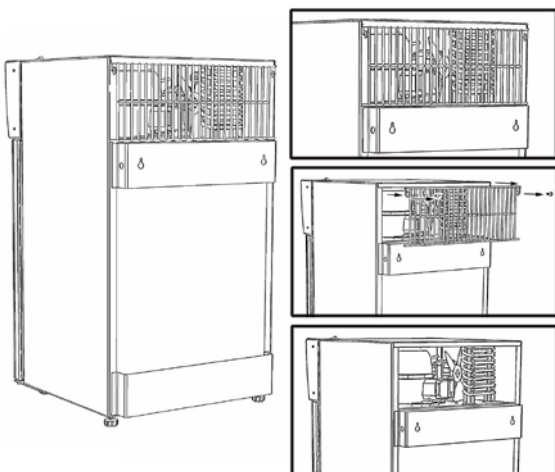
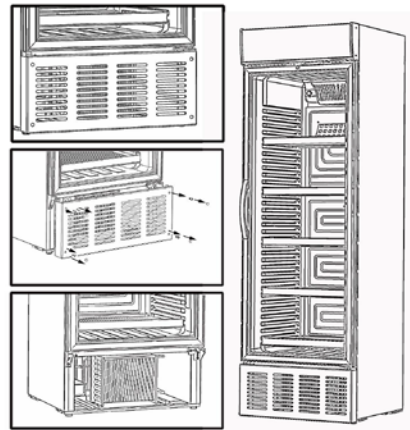
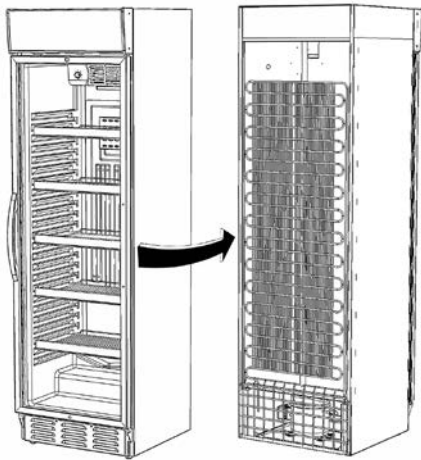

Service

Bei Versagen im Kühlsystem, prüfen Sie zunächst, ob es an der Stromversorgung liegt.

Wenn der Grund nicht gefunden werden kann, müssen Sie Ihren Lieferanten kontaktieren. Dabei immer Typnamen und Seriennummer vom Schrank mitteilen. Diese Informationen befinden sich auf dem Typenschild, das sich im Schrank oben rechts befindet.

Verwenden Sie immer autorisierten Kundendienst und originale Ersatzteile.



Dieses Gerät erfüllt die folgenden EU-Direktive:
98/37/EG
89/336/EWG
73/23/EWG

Entsorgung

Wenn der abgenutzte Schrank entsorgt werden muss, ist dies auf eine umweltmäßig rücksichtsvolle Weise vorzunehmen. Achten Sie auf besondere nationale Regeln der Entsorgung.



Consignes de sécurité importantes:

Les refroidisseurs mentionnés dans ce document sont conçus uniquement pour le stockage et le refroidissement de boissons dans des bouteilles ou des canettes.

- Pour tirer le meilleur parti du congélateur, nous vous recommandons de lire ce mode d'emploi.
- L'utilisateur est responsable d'utiliser l'appareil conformément aux instructions données.
- Contactez votre revendeur immédiatement en cas de défauts de fonctionnement.
- Placez le congélateur dans un endroit sec et ventilé.
- Conservez le congélateur à l'abri de sources de chaleur importante et ne l'exposez pas à la lumière directe du soleil.
- N'oubliez jamais que tous les appareils électriques sont des sources de danger potentiel.
- Ne stockez pas de matériaux inflammables tels que du diluant, de l'essence, etc. dans le congélateur.
- Nous déclarons n'avoir pas utilisé d'amiante ou de CFC lors de la construction.
- L'huile dans le compresseur ne contient pas de PCB.



- LA PRISE DU REFROIDISSEUR ET LA PRISE MURALE DOIVENT FOURNIR LA MISE À LA TERRE APPROPRIÉE !
- EN CAS DE RÉPARATION IL FAUT TOUJOURS DÉBRANCHER LE REFROIDISSEUR !



- POUR LES ARMOIRES AVEC RÉFRIGÉRANT R600a!

- Ce refroidisseur contient un réfrigérant inflammable; assurez un endroit bien ventilé autour de l'armoire.
- N'utilisez pas des outils mécaniques pour le dégivrage; cela peut causer des fuites dans le système de refroidissement interne.
- N'utilisez pas des outils électrique à l'intérieur de l'armoire.
- Chaque réparation de ce refroidisseur doit être effectué par un réparateur professionnel. (EN 60335-2-89: 2010)

Déballage et installation:

Examinez soigneusement le refroidisseur afin de vérifier qu'il n'a pas été endommagé pendant l'expédition avant de mettre au rebut le matériau d'emballage. En cas de dommages, contactez immédiatement le transporteur et faites établir par son mandataire un rapport d'inspection dans le but de faire une réclamation.

- Si l'armoire est encastré dans un élément d'aménagement il faut prévoir une distance de – au moins – 50 mm derrière et au-dessus de l'armoire pour assurer une ventilation suffisante.
- Vérifier que la prise de l'air dans le panneau au fond n'est pas bloquée.
- Afin d'assurer un fonctionnement correct l'armoire doit être d'aplomb, ce qui s'obtient aisément grâce aux pieds réglables à l'avant du socle:

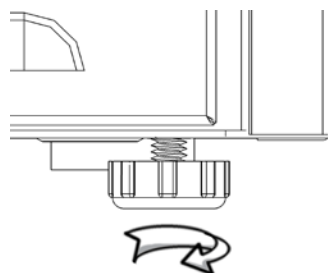

Raccordement électrique

Le congélateur fonctionne avec une alimentation de 220-240 V/50 Hz. La prise murale doit être facile d'accès.

Toutes les exigences de mise à la terre stipulées par les autorités locales doivent être respectées. La prise du congélateur et la prise murale doivent alors fournir la mise à la terre appropriée. En cas de doute, contactez votre fournisseur local ou électricien autorisé.

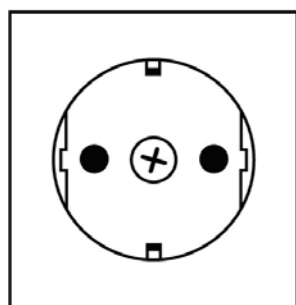

230 V ~ 50 Hz



13 A

Le cordon flexible relié à cet appareil est doté de trois âmes à utiliser avec une prise à 3 broches de 13 Amp.

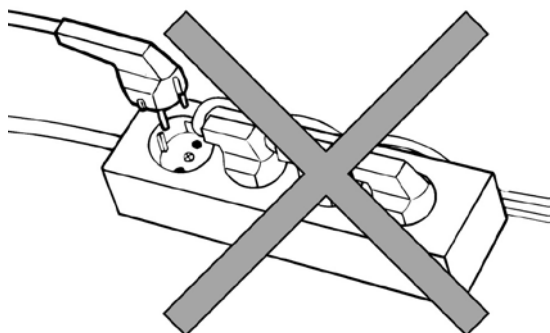

L'armoire ne doit pas être branché à une multiprise.

Démarrage

Avant l'utilisation, nous vous recommandons de nettoyer le congélateur (voir la section sur la maintenance et le nettoyage).

Important !

Si le congélateur a été placé verticalement pendant le transport, attendez 2 heures avant de le mettre en marche.

Thermostat (Voir également page 90)

Le thermostat est réglable de 1 à 7, ce qui correspond à environ 2-12 °C.

Un réglage de 3-4 serait optimal dans la plupart de cas.

Le système de refroidissement interne peut être arrêté par un réglage de 0.

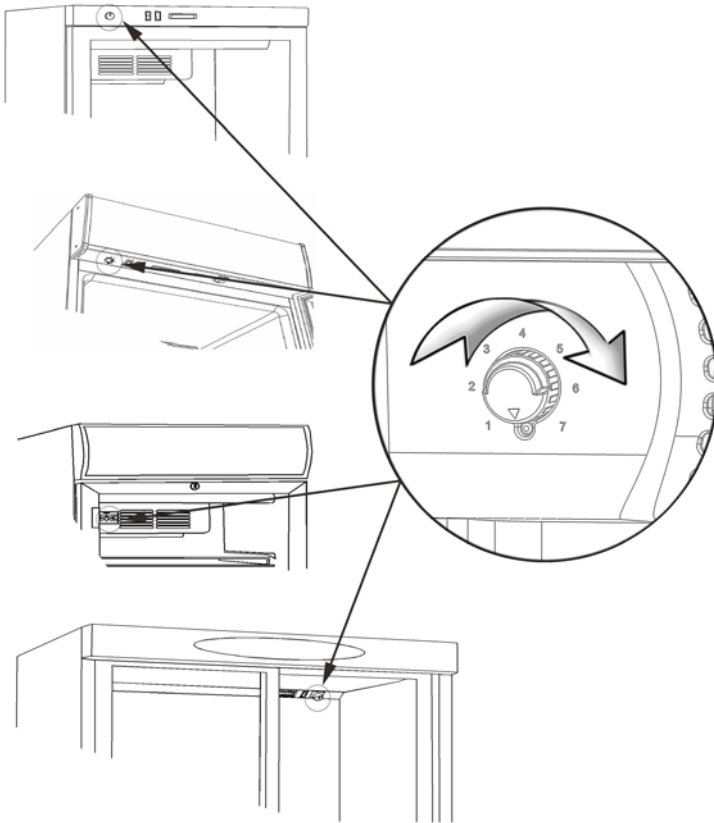

Dépendant du modèle, le thermostat peut être placé:

1. Dans le panneau en haut.
2. Sous le canopy.
3. Dans le cache de la ventilateur interne.

Thermomètre

Tous les armoires sont dotés d'un thermomètre.

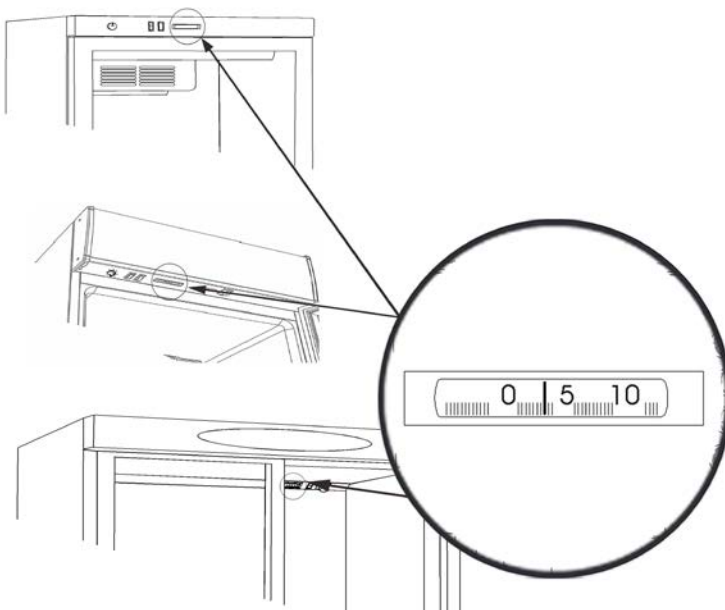

Dépendant du modèle, le thermomètre peut être placé:

1. Dans le panneau en haut
2. Sous le canopy.

Dégivrage

L'armoire se dégivre automatiquement. L'eau de dégivrage est évacuée et s'évapore dans un récipient placé dans le compartiment compresseur.

Serrure

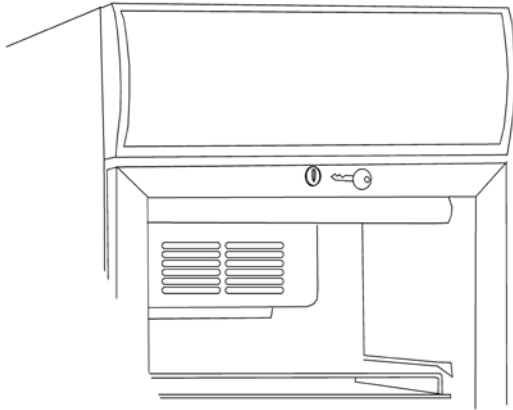

Les armoires avec les portes charnières sont livrés avec une serrure placée en haut dans la porte.

Éclairage

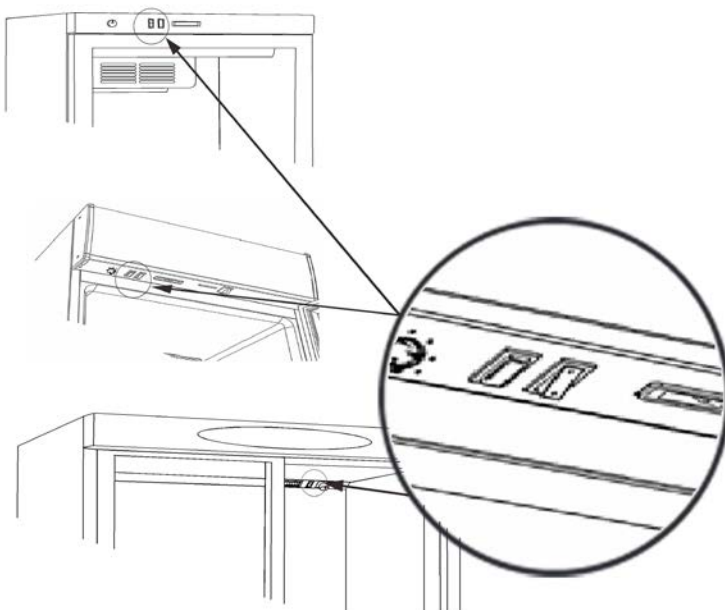

Les armoires avec éclairage sont dotés d'un commutateur qui est placé (dépendant du modèle) :

1. Dans le panneau en haut
2. Sous le canopy.
3. Dans le cache du ventilateur interne.

Remplacement éclairage



N'oubliez pas d'éteindre l'armoire au niveau de la prise avant de remplacer l'éclairage !



Éclairage interne:

Le tube néon interne peut être remplacé par un tube similaire en enlevant le dévoilement.

L'éclairage LED interne doit être remplacé par des pièces identiques ; veuillez contacter votre revendeur pour avoir des pièces originales.

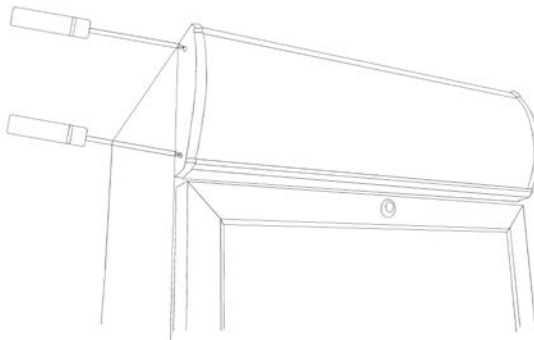

Éclairage du top lumineux (canopy):

L'éclairage externe du canopy peut être remplacé en enlevant une pièce latérale. Le plexi peut s'enlever latéralement pour accéder le tube néon, qui doit être remplacé par un tube similaire.

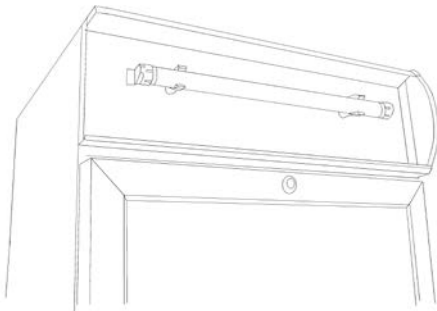

L'éclairage externe LED dans le canopy peut être remplacée de la même manière. Veuillez contacter votre revendeur pour avoir des pièces originales.

Pousser le plexi doucement en place et remonter la pièce latérale.

Changement de côté des charnières de la porte

Quelques modèles ont des portes reversibles. Procédez comme suit pour changer le côté des charnières de droit à gauche et vice versa.

Cette opération est rendue plus facile en plaçant l'armoire doucement sur le dos, éventuellement sur un diable.

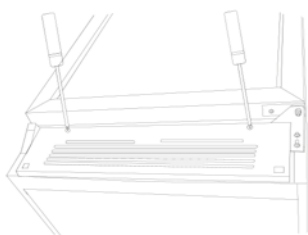

1. Démontez le panneau au fond.

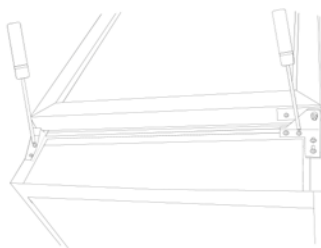

2. Démontez la charnière au fond et la ferrure de support.

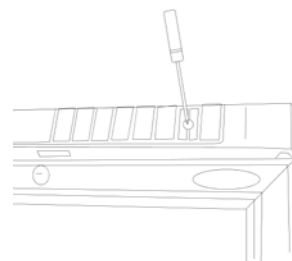

3. Démontez le panneau en haut / le canopy.

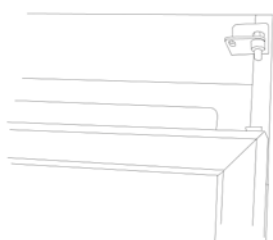

4. Soulever la porte et tirer-la environ 10 cm vers le bas.

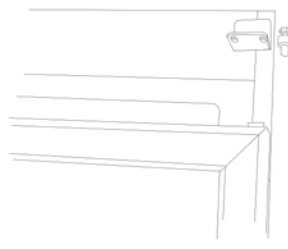

5. Démontez le pivot de la charnière en haut.

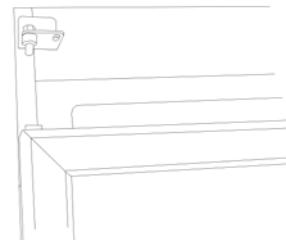

6. Monter le pivot de la charnière dans le côté contraire sans le tendre.

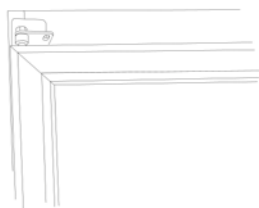

7. Placer la porte en place dans la charnière en haut.

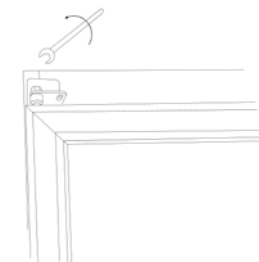

8. Tendre le pivot de la charnière en haut.

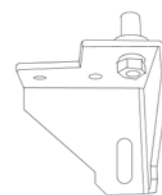

9. Démontez le pivot de la charnière au fond, et tourner la charnière 90 degrés.



10. Rémonter le pivot sur la charnière tournée.

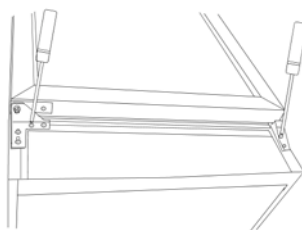

11. Monter la charnière du fond et la ferrure de support dans le nouvel côté.

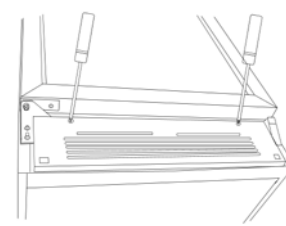

12. Remonter le panneau au fond..

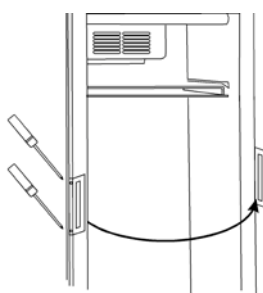

13. Placer la poignée dans le côté opposé.

Support mural

Quelques modèles sont produits avec support mural, voir ci-dessous:

	A	Max. chargement:
FS60CP	345	20 kg.
FS80CP	360	30 kg.
FSC100	527	30 kg.

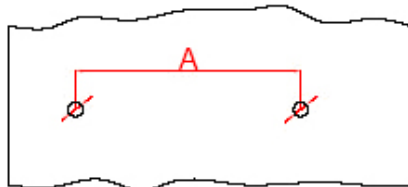

Forer 2 trous avec un diamètre de 8 mm et une profondeur de 40 mm avec la distance mentionnée A.

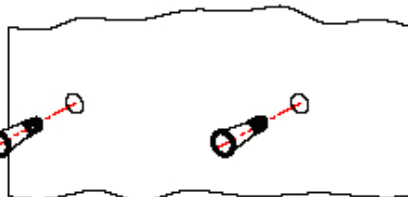

Monter des chevilles de 8 mm.

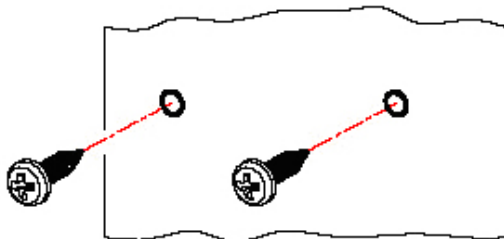

Utiliser des vis de 4,8 x 38 mm. DIN NO:7981.

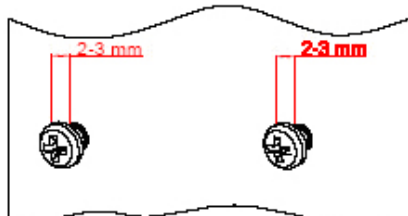

Assurer que la distance entre le mur et le vis est 2-3 mm.

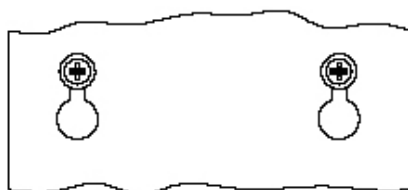

Assurer que les vis s'insèrent parfaitement dans le support mural.

Entretien

Le système de refroidissement est un système fermé hermétiquement qui ne nécessite pas d'être surveillé, mais uniquement d'être nettoyé.



N'oubliez pas d'éteindre l'armoire au niveau de la prise avant le nettoyage !

C'est recommandable de nettoyer le condensateur 2-4 fois par an, ce qui influence la consommation d'énergie et la durée des pièces techniques. Nettoyer-le à l'aide d'un aspirateur brosse.

L'armoire se dégivre automatiquement. L'eau de dégivrage est évacuée et s'évapore dans un récipient placé dans le compartiment compresseur.

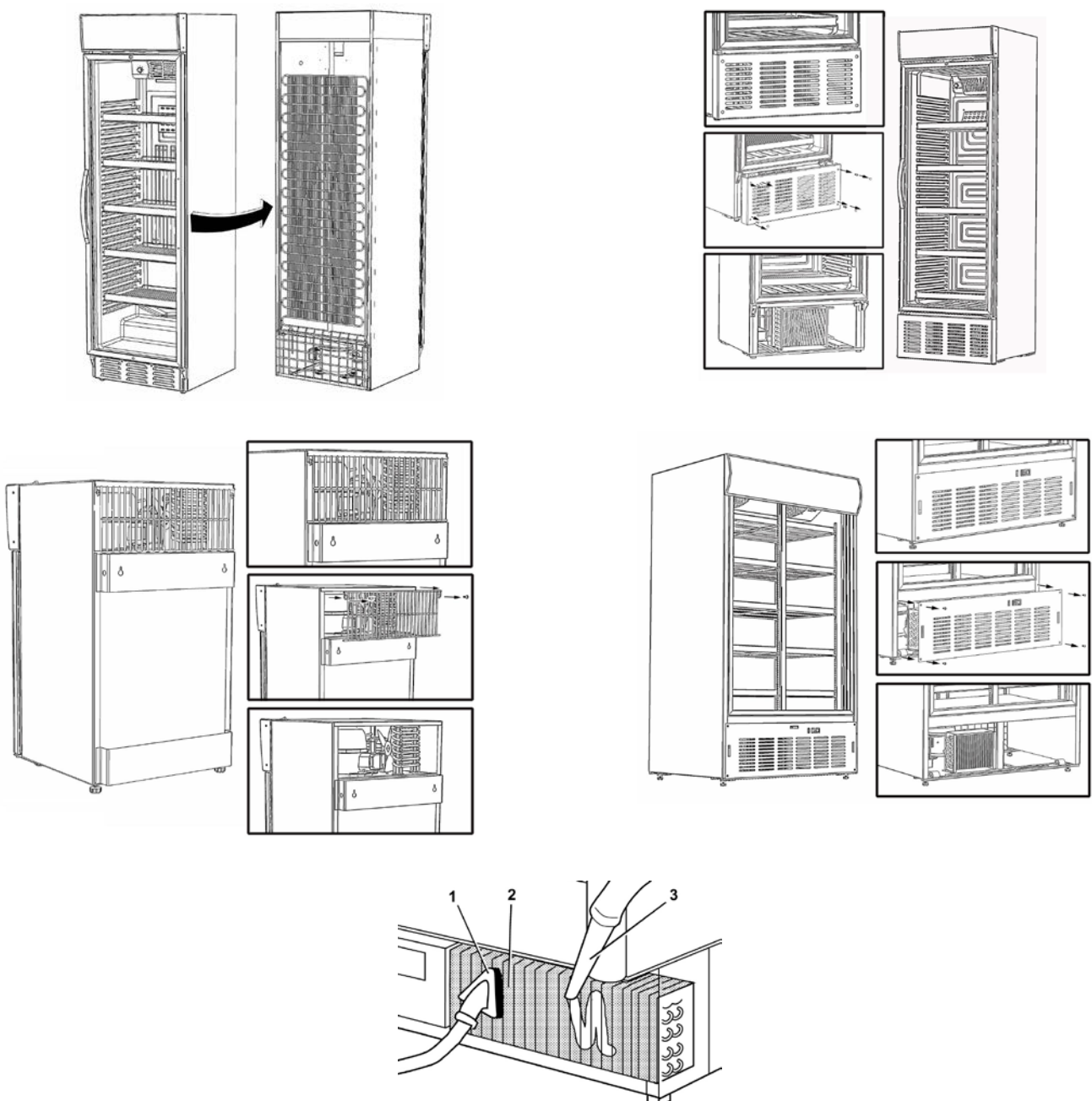

Service

Si l'armoire ne refroidit pas, vérifiez si la raison est une panne de courant.

Si vous ne pouvez pas détecter la raison de la défaillance de l'armoire, veuillez contacter votre fournisseur. Indiquer le modèle et le numéro de série de l'armoire. Vous pouvez trouver cette pièce d'information sur l'étiquette signalétique, normalement placée à droite à l'intérieur de l'armoire.

Utiliser toujours des réparateurs autorisés et des pièces détachées originales.



Cet appareil est conforme aux directives UE suivantes:

*98/37/EC
89/336/EEC
73/23/EEC.*

Mise au rebut

La mise au rebut de l'armoire réfrigérée doit être effectuée dans le respect de l'environnement. Veuillez consulter la réglementation existante sur la mise au rebut. Il peut y avoir des exigences et conditions spéciales à respecter.



Belangrijke aanwijzingen:

De in dit document genoemde apparaten zijn uitsluitend bedoeld voor het bewaren en koelen van dranken in flessen en blikken.

- Lees de handleiding zodat u het apparaat optimaal kunt benutten.
- Het is de verantwoordelijkheid van de gebruiker om het apparaat te gebruiken overeenkomstig de gegeven aanwijzingen.
- Neem bij defecten direct contact op met de leverancier.
- Het apparaat is uitsluitend bedoeld voor gebruik binnenshuis.
- Plaats het apparaat in een droge en voldoende geventileerde ruimte.
- Plaats het apparaat niet in de buurt van een warmtebron of rechtstreeks zonlicht.
- Plaats het apparaat niet in de buurt van een systeem voor ventilatie of air conditioning.
- Houd er rekening mee dat alle elektrische apparaten gevaar kunnen opleveren.
- Bewaar geen explosieven in het apparaat zoals gas, benzine, ether of soortgelijke substanties.
- Bij de productie van dit apparaat zijn geen asbest of CFC gebruikt.
- De olie in de compressor bevat geen PCB.



- DIT APPARAAT MOET ALTIJD EEN GEAARDE STEKKER HEBBEN.
- TREK BIJ REPARATIES ALTIJD DE STEKKER UIT HET STOPCONTACT.



- ALLEEN VOOR APPARATEN MET KOELVLOEISTOF R600a.

- Dit apparaat bevat een brandbaar koelmiddel, dus zorg voor voldoende ventilatie rond het apparaat.
- Gebruik geen mechanische apparaten tijdens het ontdooien, dat kan lekkage van het koelsysteem veroorzaken.
- Gebruik geen elektrische apparaten binnen het gekoelde opslagvak.
- Eventuele reparaties aan het apparaat moeten worden uitgevoerd door een ervaren technicus (EN 60335-2-89: 2010).

Uitpakken en installeren:

Verwijder de verpakking en controleer de kast op vervoersschade.

Eventuele vervoersschade moet worden gemeld aan het vervoersbedrijf en genoteerd op de vrachtbrief.

- Zorg bij inbouwen voor een afstand van ten minste 50 cm achter en boven het apparaat.
- Zorg er voor dat de luchtopening in het onderpaneel niet geblokkeerd wordt.
- Zet het apparaat vlak neer voor een juiste werking. Stel hiervoor de voeten in.:

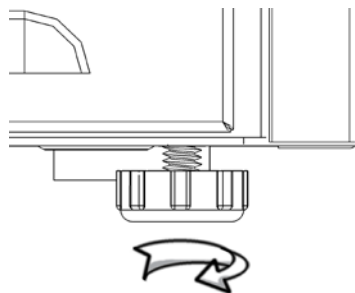

Elektrische aansluitingen

Het apparaat is ontworpen voor 220-240 V/50 Hz. Het apparaat moet worden aangesloten op een goed bereikbaar stopcontact.

Dit apparaat moet extra worden beschermd overeenkomstig de energieregels. Dit geldt ook bij vervanging van een bestaand apparaat dat deze extra bescherming mist.

Gebruik altijd een geaarde stekker. De draad met geel/groene isolatie is de aarddraad (gemarkeerd ⊕).

In alle andere gevallen kan een geautoriseerd technicus u vertellen hoe u de extra bescherming van het apparaat verkrijgt. Mocht het gebouw niet over een extra bescherming beschikken, wordt u sterk aangeraden om een aardlekschakelaar te laten monteren.

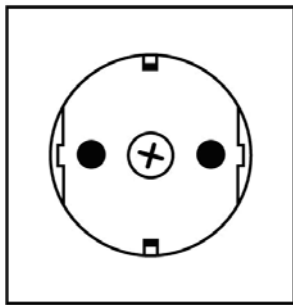

230 V ~ 50 Hz



13 A

Het apparaat moet zijn aangesloten op een 13 A geaard stopcontact.

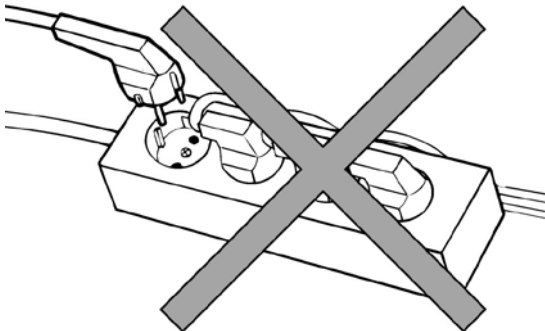

Het apparaat mag niet worden aangesloten op een verdeelstekker.

Het apparaat starten

Voordat u het apparaat in gebruik neemt, wordt u aangeraden om het schoon te maken – zie het hoofdstuk over onderhoud.

BELANGRIJK!

Mocht de kast tijdens het vervoer op zijn kant hebben gelegen, moet u hem 2 uur rechtop laten staan voordat u hem inschakelt.

Thermostaat (Zie ook pagina 90)

De thermostaat heeft een instelschaal van 1 tot 7, overeenkomend met ongeveer 2-12 °C.
In de meeste gevallen is de stand 3-4 optimaal.
U kunt het koelsysteem uitschakelen op 0.

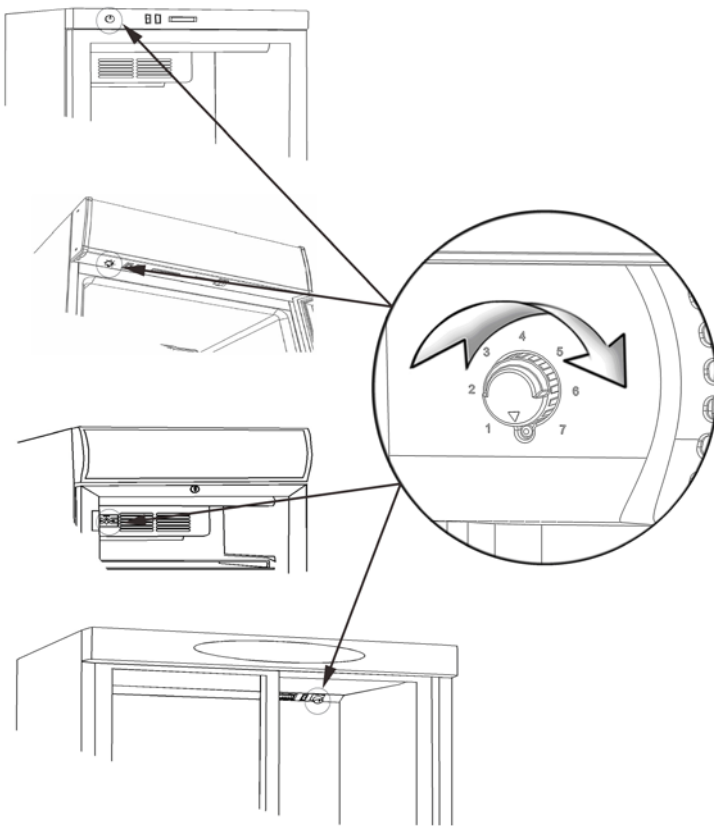

Afhankelijk van het model kan de thermostaat zich bevinden:

1. in het bovenpaneel
2. onder de kap
3. onder de klep van de interne ventilator

Thermometer

Alle apparaten zijn voorzien van een thermometer.

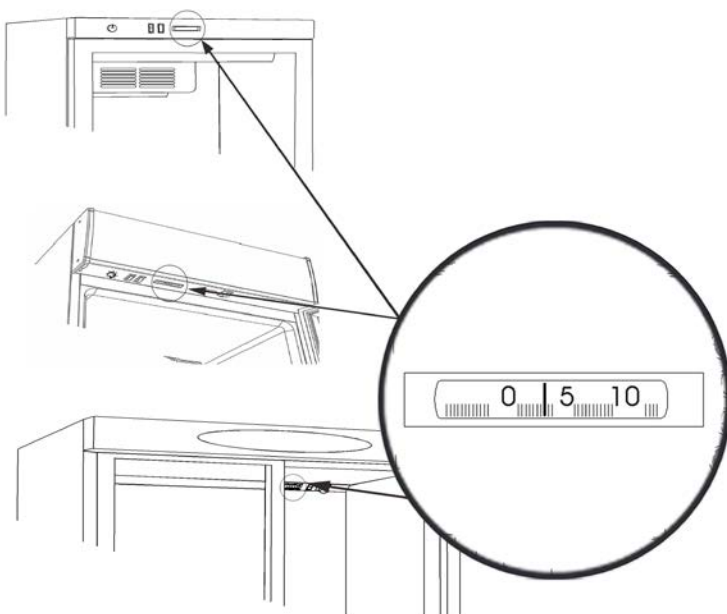

Afhankelijk van het model kan de thermometer zich bevinden:

1. in het bovenpaneel
2. onder de kap

Ontdooien

Het apparaat beschikt over automatisch ontdooien. Dooiwater wordt verdampt in een druppelbak in het compressorcompartiment.

Slot

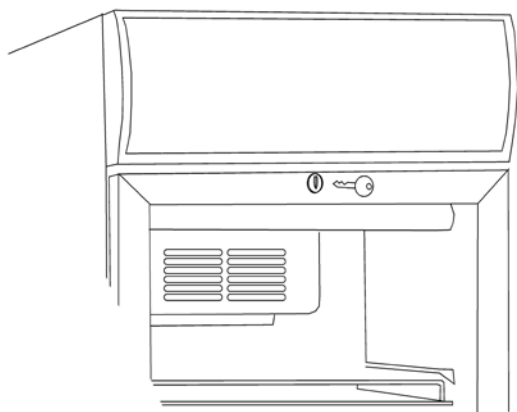

Het apparaat met een scharnierende deur heeft een slot. Het slot bevindt zich bovenaan in de deur.

Interne verlichting

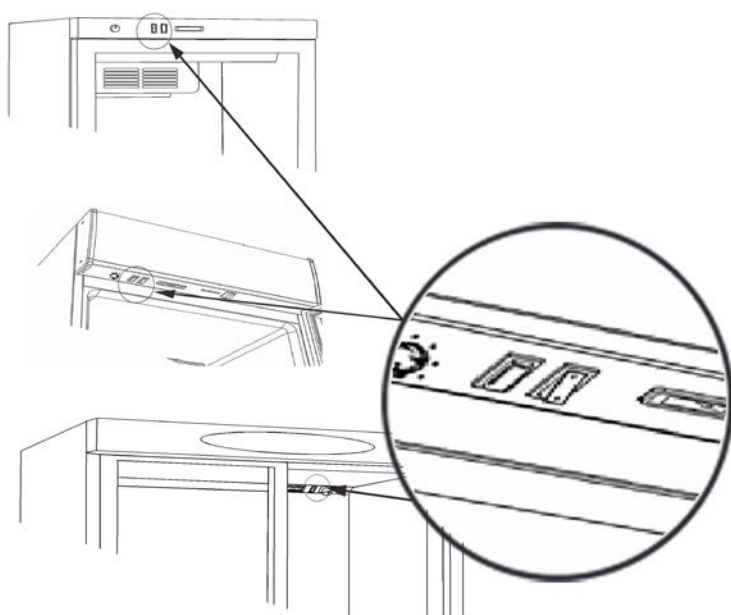

Apparaten met interne verlichting zijn voorzien van een lichtschaakelaar. Afhankelijk van het model bevindt deze zich:

1. in het bovenpaneel
2. onder de kap
3. onder de klep van de interne ventilator

De lamp vervangen



VERGEET NIET om de stroom uit te schakelen voordat u de lamp vervangt!



Interne verlichting:

De interne TL-lamp wordt vervangen door de kap over de lamp te verwijderen. Vervang de buis door een gelijksoortig type.

Het interne LED-licht moet door een gelijkstoortig type worden vervangen. Neem contact op met de leverancier voor originele vervangende onderdelen.

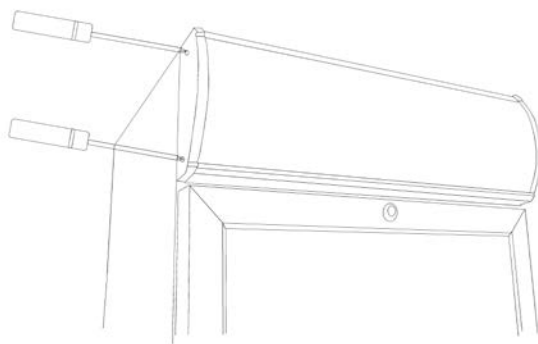

Lamp in de kap:

De externe TL-lamp in de kap wordt vervangen door het eindstuk van de kap te verwijderen. Trek de plaat naar één kant zodat u toegang hebt tot de TL-lamp. Vervang de buis door een gelijksoortig type.

De externe LED-verlichting in de kap wordt op dezelfde manier vervangen.

Neem contact op met de leverancier voor originele vervangende onderdelen.

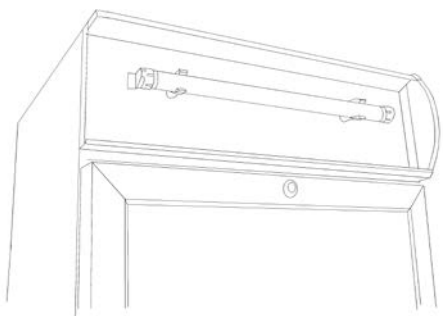

Druk de plaat weer voorzichtig op zijn plaats en plaats het eindstuk terug.

Deur omkeren

Sommige modellen hebben een omkeerbare deur. Volg de aanwijzingen hieronder om de deur om te keren van rechts naar links en omgekeerd.

Deze actie is eenvoudig uit te voeren door de kast voorzichtig op zijn rug of op een trolley te leggen.

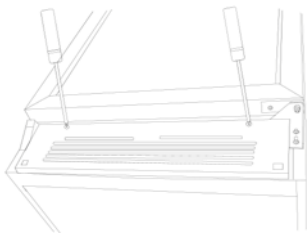

1. Verwijder het onderpaneel

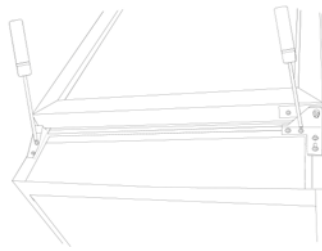

2. Verwijder het onderste scharnier en de steunfitting.

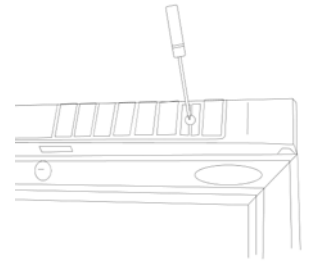

3. Verwijder het bovenpaneel/de kap.

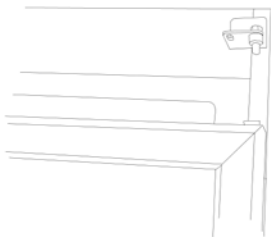

4. Licht de deur op en trek hem ongeveer 10 cm. omlaag.

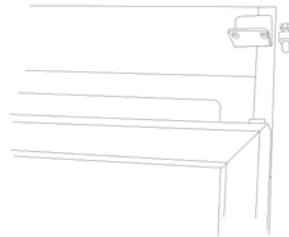

5. Verwijder de bovenste scharnierpen.

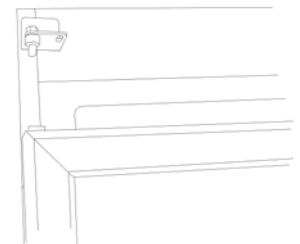

6. Steek de scharnierpen in de tegenoverliggende kant zonder hem vast te zetten.

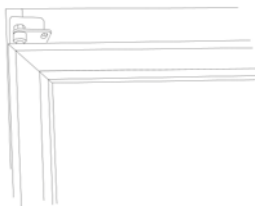

7. Licht de deur op zijn plaats in het bovenste scharnier.



8. Draai de bovenste scharnierpen vast.

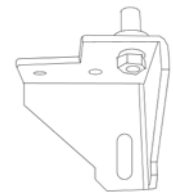

9. Verwijder de onderste scharnierpen en draai het onderscharnier 90 graden.



10. Monteer de onderste scharnierpen in het gedraaide onderscharnier.

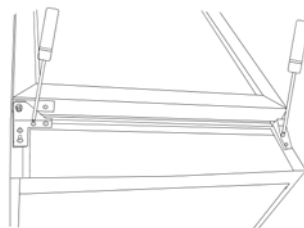

11. Monteer het onderscharnier op de tegenoverliggende kant.

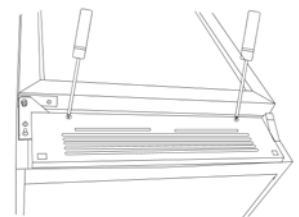

12. Monteer de steunfitting op de tegenoverliggende kant.

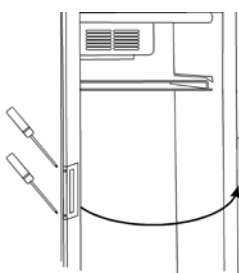

13. Verplaats de handgreep naar de tegenoverliggende kant.

Muurmontage

Sommige modellen zijn voorbereid op muurmontage. Zie hieronder.

	A	Max. belasting:
FS60CP	345	20 kgs.
FS80CP	360	30 kgs.
FSC100	527	30 kgs.

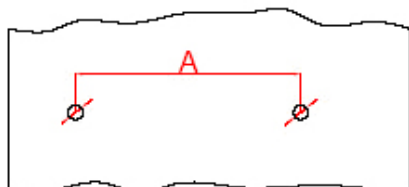

Boor twee gaten met een doorsnede van 8 mm en een diepte van 40 mm en een afstand zoals afgebeeld in tekening (A).

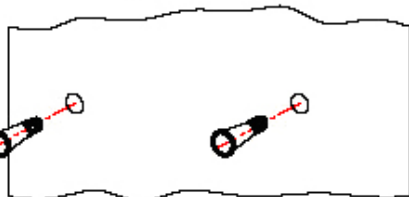

Steek 8 mm. pluggen in de gaten.

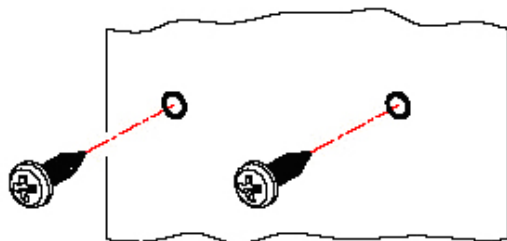

Gebruik schroeven 4,8 x 38 mm, DIN NO.7981.

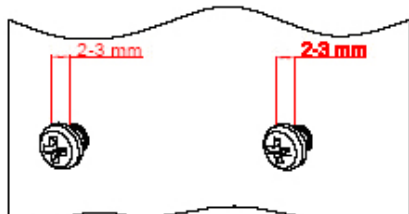

Zorg er voor dat de afstand tussen de schroefkop en de muur 2-3 mm is.



Zorg er voor dat de schroeven perfect in de muursteun passen.

Onderhoud en reiniging

Het apparaat beschikt over een gesloten koelsysteem dat normaal geen onderhoud nodig heeft.



VERGEET NIET om de stroom uit te schakelen voordat u het apparaat schoonmaakt!

Aanbevolen wordt echter om de condensor 2 tot 4 maal per jaar schoon te maken met een borstel of een stofzuiger. Dit kan het energieverbruik en de levensduur van de kast beïnvloeden.

Het apparaat beschikt over automatisch ontdooien. Dooiwater wordt verdampt in een druppelbak in het compressorcompartment.

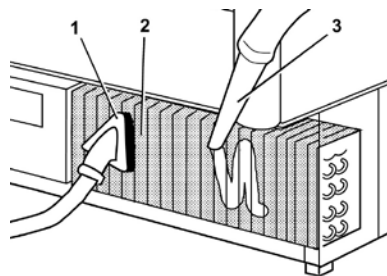
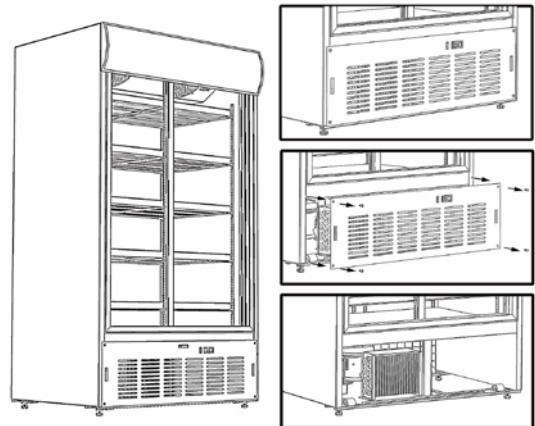
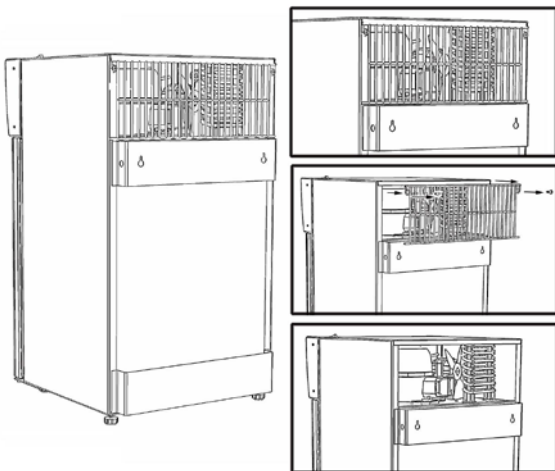
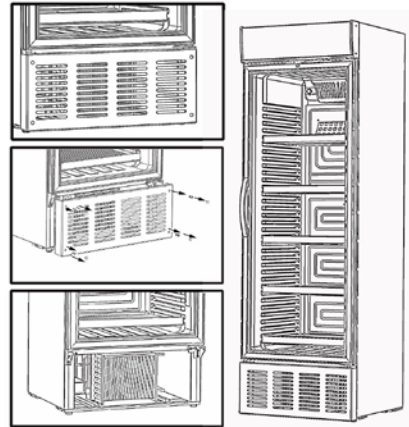
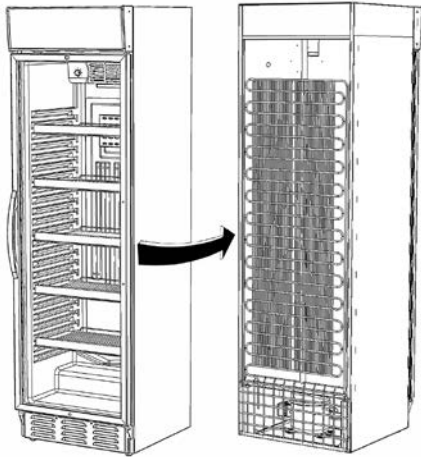

Onderhoud

Bij niet koelen controleren of er een defect is in de stroomvoorziening.

Als u geen storing kunt vinden, moet u contact opnemen met uw dealer.

U moet uw dealer het modelnummer en het serienummer doorgeven die u kunt vinden op het typeplaatje dat gewoonlijk rechts in de kast is gemonteerd.

Gebruik altijd geautoriseerde technici en originele vervangende onderdelen.



Dit apparaat voldoet aan de volgende EU-richtlijnen:

98/37/EG

89/336/EG

73/23/EG

Verwijderen

Het verwijderen van oude apparatuur moet op de juiste wijze plaatsvinden ter bescherming van het milieu.

Volg de landelijke richtlijnen voor het verwijderen van oude apparatuur.



Instrucciones importantes:

Los aparatos mencionados en este documento tienen como único uso previsto la conservación y el enfriamiento de bebidas envasadas en botellas y latas.

- Lea el manual para sacar el máximo partido de este electrodoméstico.
- Es responsabilidad del usuario utilizar el electrodoméstico de acuerdo con las instrucciones facilitadas.
- Póngase inmediatamente en contacto con el distribuidor en caso de detectar cualquier anomalía.
- El electrodoméstico debe usarse únicamente en interiores.
- El electrodoméstico debe colocarse en una estancia seca y dotada de ventilación suficiente.
- El electrodoméstico no debe colocarse cerca de fuentes de calor o bajo la luz directa del sol.
- El electrodoméstico no debe colocarse cerca de sistemas de ventilación o aire acondicionado.
- Tenga en cuenta que todos los electrodomésticos pueden plantear riesgos.
- No almacene sustancias explosivas como gas, gasolina, éter u otras sustancias similares en el electrodoméstico.
- En la fabricación de este electrodoméstico no se ha utilizado amianto ni CFC.
- El aceite del compresor no contiene PCB.



- ESTA UNIDAD DEBE DISPONER SIEMPRE DE UN ENCHUFE PROVISTO DE TOMA DE TIERRA
- DESENCHUFE LA UNIDAD SIEMPRE QUE VAYA A REALIZAR UNA REPARACIÓN EN ELLA



- ¡SOLO PARA LOS MODELOS QUE INCORPOREN REFRIGERANTE R600a!

- Este electrodoméstico contiene un refrigerante inflamable. Por lo tanto, asegúrese de disponer de una buena ventilación a su alrededor.
- No utilice dispositivos mecánicos para descongelar el electrodoméstico, ya que podría causar fugas en el sistema de refrigeración.
- No utilice aparatos eléctricos en el interior del compartimento de almacenamiento refrigerado.
- Deje cualquier reparación del electrodoméstico en manos de un técnico cualificado (EN 60335-2-89: 2010).

Desembalaje e instalación:

Retire el embalaje y compruebe que la unidad no haya sufrido daños durante el transporte. Ponga en conocimiento de la compañía de transporte y anote en la nota de entrega cualquier daño producido durante el transporte.

- Asegúrese durante la instalación de que haya una distancia de al menos 50 cm por detrás y por encima de la unidad.
- Asegúrese de que la toma de aire del panel inferior no esté bloqueada.
- Coloque la unidad en posición nivelada para su correcto funcionamiento. Para ello, sírvase de los pies ajustables:

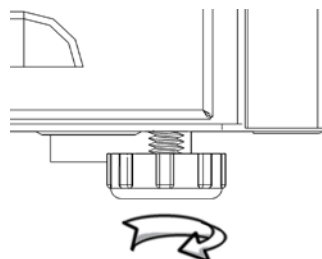

Conexión eléctrica

Este electrodoméstico está diseñado para su uso a 220-240 V/50 Hz. Debe enchufarse a una toma de corriente accesible.

Este electrodoméstico debe disponer de una protección adicional de acuerdo con las normativas sobre electricidad. Esto es aplicable también en el caso de que reemplace una unidad existente que no disponga de protección adicional.

Use siempre un enchufe de tres clavijas. El hilo con aislante verde/amarillo debe conectarse a tierra (con marca ⊕).

En todos los demás casos, un electricista autorizado le informará sobre cómo obtener la protección adicional para el electrodoméstico. En caso de el edificio no disponga de protección adicional, las autoridades recomiendan que un electricista instale un interruptor PFI o HPFI (disyuntor).

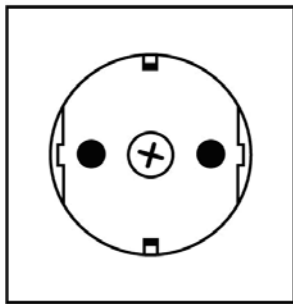

230 V ~ 50 Hz



13 A

El electrodoméstico debe enchufarse a una toma de corriente protegida de 13 A.

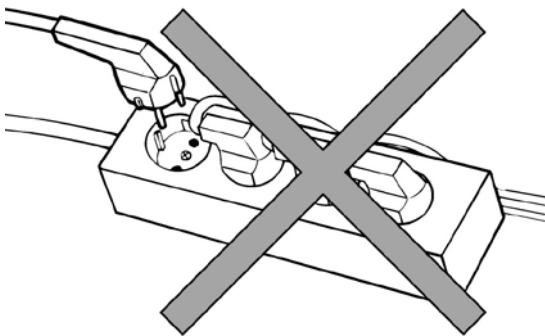

El electrodoméstico no debe enchufarse a una toma de distribución multipolar.

Puesta en marcha de la unidad

Antes de poner en marcha la unidad, se recomienda limpiarla. Vea la sección de mantenimiento.

Importante

Si la unidad se ha transportado acostada, déjelo 2 horas de pie antes de ponerla en marcha.

Termostato (Véase también la página 90)

El termostato se puede ajustar en una escala del 1 al 7, que corresponde aproximadamente a un rango de entre 2 y 12 °C.

El ajuste óptimo está, en la mayoría de los casos, en las posiciones 3 o 4.

El sistema de refrigeración se puede desconectar en la posición 0.

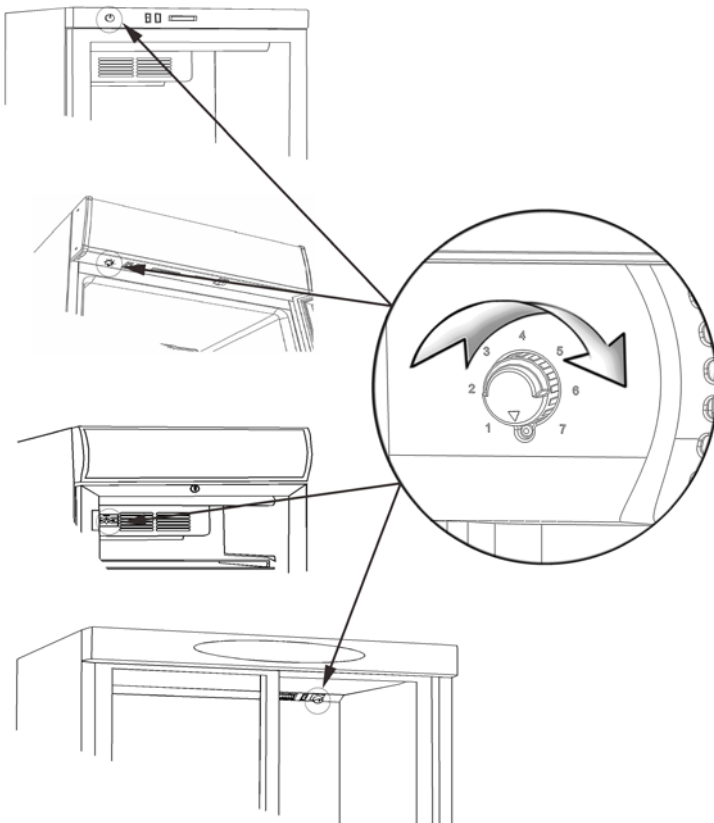

Dependiendo del modelo, el termostato se puede encontrar en una de las siguientes posiciones:

1. En el panel superior
2. Debajo de la marquesina
3. En la cubierta del ventilador interno

Termómetro

Todos los modelos incorporan un termómetro.

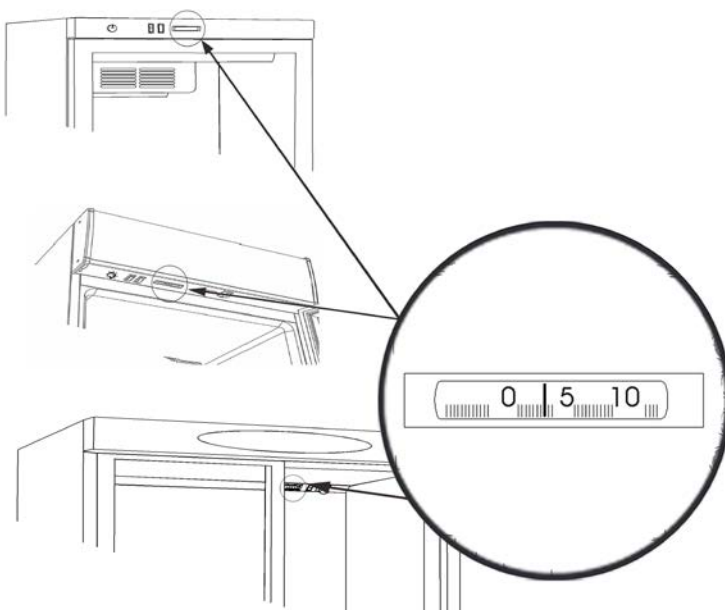

Dependiendo del modelo, el termómetro se puede encontrar en una de las siguientes posiciones:

1. En el panel superior
2. Debajo de la marquesina

Descongelación

La unidad dispone de descongelación automática. El agua procedente de la descongelación va a parar a una bandeja de goteo situada en el compartimento del compresor, en donde se evapora.

Cierre

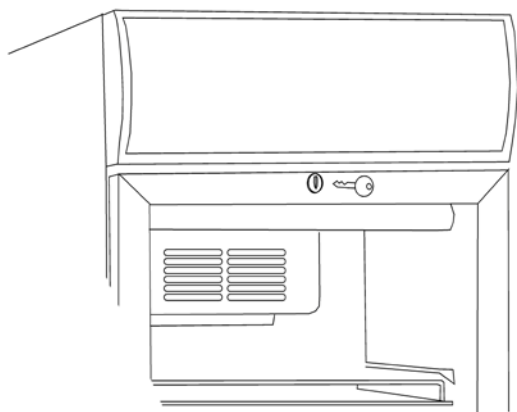

Las unidades equipadas con puerta con bisagras disponen de un cierre que se encuentra en la parte superior de la puerta.

Luz interna

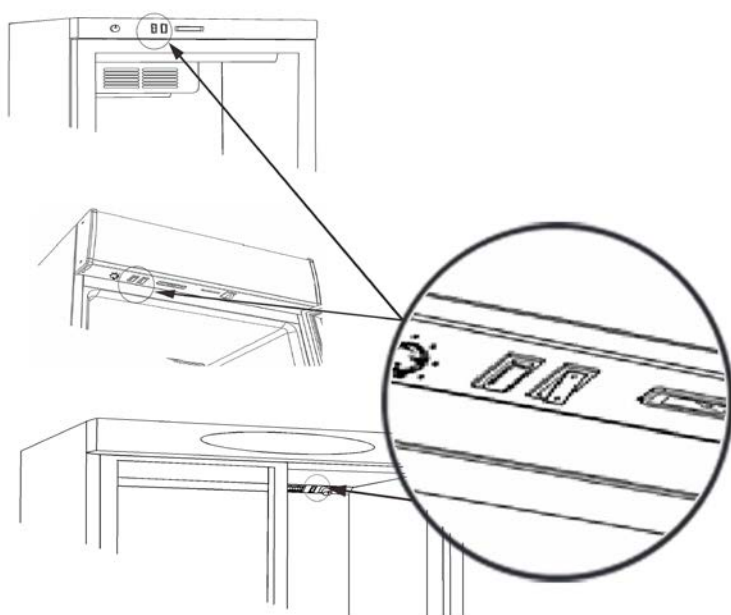

Las unidades equipadas con luz interna dispone de un interruptor para la luz. Dependiendo del modelo, dicho interruptor se encontrará en una de las siguientes posiciones:

1. En el panel superior
2. Debajo de la marquesina
3. En la cubierta del ventilador interno

Sustitución de la lámpara



NO OLVIDE desenchufar la unidad antes de sustituir la lámpara!



Luz interna:

El fluorescente interno se sustituye desmontando la cubierta de la lámpara. Sustituya el fluorescente por otro del mismo tipo.

La lámpara LED interna debe sustituirse por otra del mismo tipo. Póngase en contacto con su distribuidor local para obtener piezas de recambio originales.

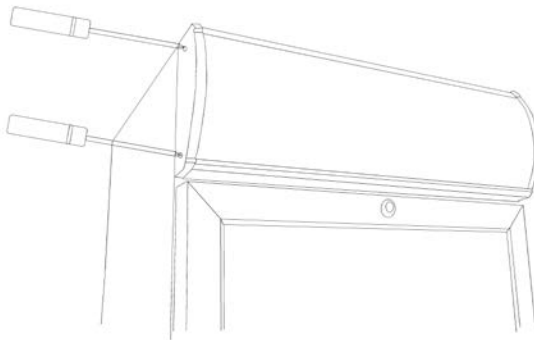

Luz de la marquesina:

El fluorescente externo situado en la marquesina se sustituye desmontando la pieza del extremo de la marquesina. Desplace a un lado la placa de la marquesina para tener acceso al fluorescente. Sustituya el fluorescente por otro del mismo tipo.

La lámpara LED externa de la marquesina se sustituye de la misma forma.

Póngase en contacto con su distribuidor local para obtener piezas de recambio originales.

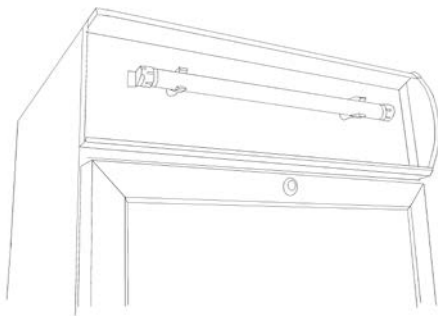

Empuje con cuidado la placa de la marquesina para volverla a poner en su sitio y vuelva a montar la pieza del extremo.

Inversión de la puerta

Algunos modelos cuentan con puertas reversibles. Siga las instrucciones que se indican a continuación para invertir las puertas de derecha a izquierda o viceversa.

Esta operación se realiza fácilmente tumbando con cuidado la unidad sobre su parte trasera o sobre una carretilla de carga.

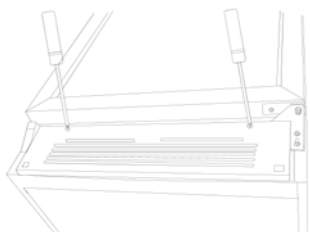

1. Retire el panel inferior

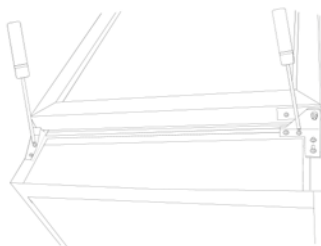

2. Retire la bisagra inferior y el accesorio de sujeción.

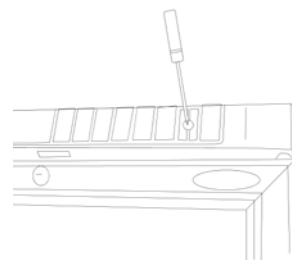

3. Retire el panel y la marquesina superiores.

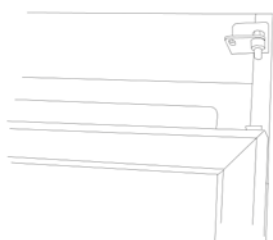

4. Levante la puerta y empujela aproximadamente 10 cm hacia abajo.

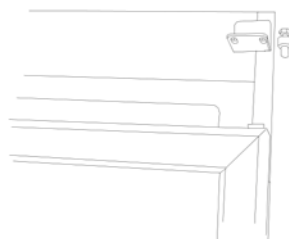

5. Retire el pasador de la bisagra superior.

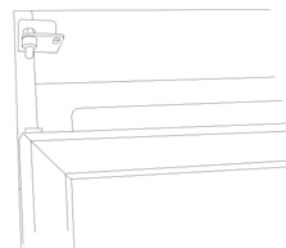

6. Coloque el pasador de la bisagra en el lado opuesto, sin apretarlo.

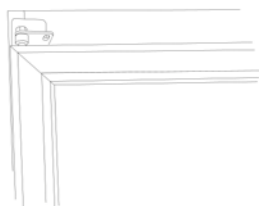

7. Levante la puerta, haciéndola encajar en la bisagra superior.



8. Apriete el pasador de la bisagra superior.

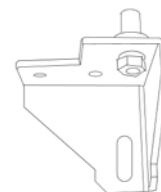

9. Retire el pasador de la bisagra inferior y gire 90 grados la bisagra inferior.



10. Vuelva a colocar el pasador de la bisagra inferior en la bisagra inferior que ha girado.

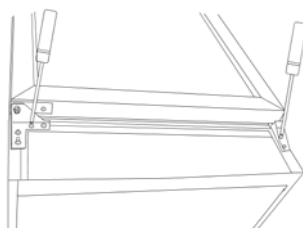

11. Coloque la bisagra inferior en el lado opuesto.

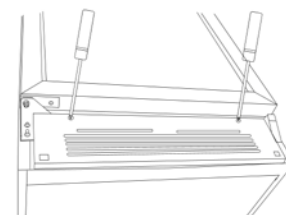

12. Coloque el accesorio de sujeción en el lado opuesto.

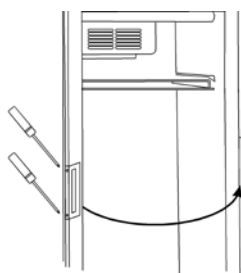

13. Instale el asa en el lado opuesto.

Instalación en pared

Algunos modelos están preparados para su instalación en pared. Vea a continuación.

	A	Carga máxima:
FS60CP	345	20 kgs.
FS80CP	360	30 kgs.
FSC100	527	30 kgs.

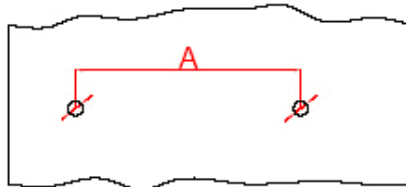

Haga dos agujeros con un diámetro de 8 mm, una profundidad de 40 mm y la distancia que se indica en la ilustración (A).

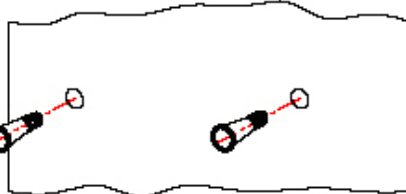

Inserte tacos de 8 mm.

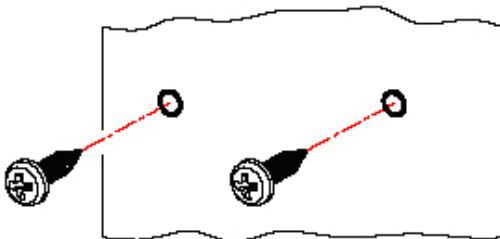

Use tornillos de 4,8 x 38 mm, DIN NO.7981.

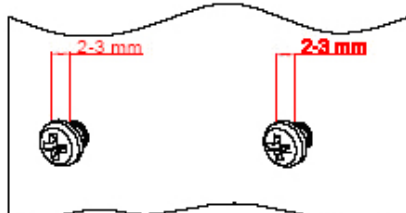

Asegúrese de que la distancia entre la cabeza del tornillo y la pared sea de entre 2 y 3 mm.

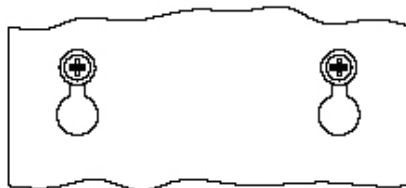

Asegúrese de que los tornillos encajen perfectamente en el accesorio de instalación en pared.

Mantenimiento

La unidad dispone de un sistema de refrigeración cerrado, que normalmente no requiere de ningún mantenimiento.



NO OLVIDE desenchufar la unidad antes de limpiarla!

Sin embargo, se recomienda limpiar el condensador entre 2 y 4 veces al año por medio de un cepillo o un aspirador. Con ello puede reducir el consumo energético de la unidad y prolongar su vida útil.

La unidad dispone de descongelación automática. El agua procedente de la descongelación va a parar a una bandeja de goteo situada en el compartimento del compresor, en donde se evapora.

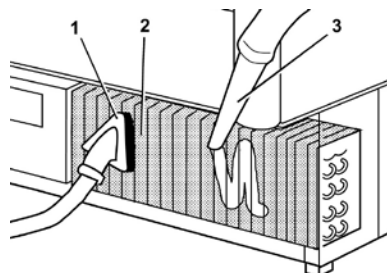
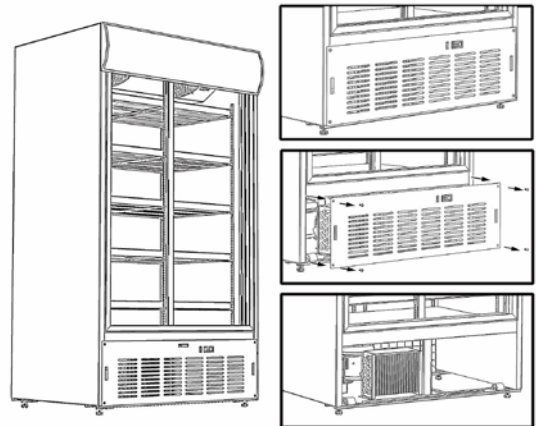
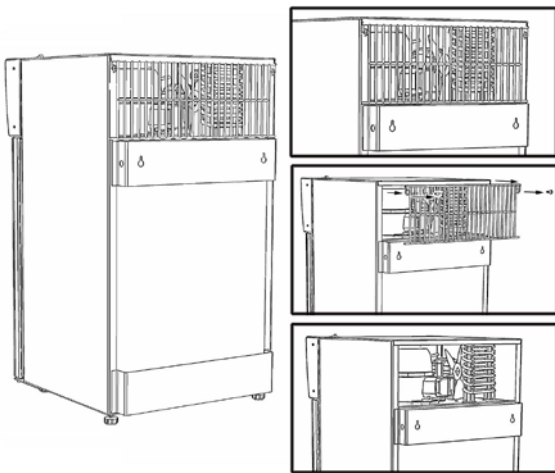
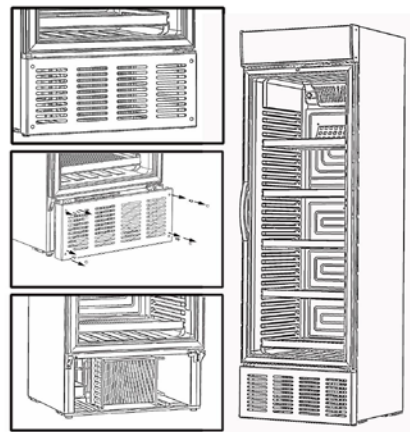
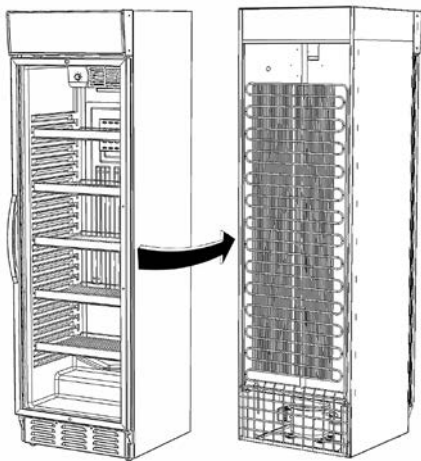

En caso de avería

En caso de que la unidad no enfríe, compruebe que no haya ningún fallo de alimentación.

En caso de que no descubra ningún fallo, póngase en contacto con su distribuidor.

Deberá comunicar a su distribuidor el código de modelo y el número de serie que figuran en la placa de datos, que normalmente se encuentra en el lado interior derecho de la unidad.

Deje siempre las reparaciones en manos de técnicos autorizados y utilice recambios originales.



Este electrodoméstico cumple con las siguientes directivas de la UE:

98/37/EC

89/336/EEC

73/23/EEC

Eliminación

Los electrodomésticos viejos deben eliminarse de forma correcta para proteger el medio ambiente. Respete las normativas nacionales relativas a la eliminación de electrodomésticos viejos.



Instruções importantes:

Os aparelhos mencionados neste documento destinam-se apenas à conservação e arrefecimento de bebidas em garrafa ou lata.

- Leia o manual para usufruir de todos os benefícios proporcionados pelo aparelho.
- A utilização do aparelho de acordo com as instruções fornecidas é da responsabilidade do utilizador.
- Contacte imediatamente o distribuidor em caso de defeitos.
- O aparelho foi concebido apenas para utilizar em recintos fechados.
- O aparelho deve ficar instalado num recinto seco e com suficiente ventilação.
- O aparelho não deve ficar junto a uma fonte de calor nem exposto à luz directa do sol.
- O aparelho não deve ficar instalado junto de um sistema de ventilação ou ar condicionado.
- Nota: todos os aparelhos eléctricos poderão constituir perigo.
- Não armazene substâncias explosivas, tais como gás, gasolina, éter ou produtos afins no interior do aparelho.
- A produção deste aparelho não incluiu o recurso a amianto e CFC.
- O óleo no compressor não contém PCB.



- ESTE APARELHO DEVE POSSUIR SEMPRE UMA FICHA COM LIGAÇÃO À TERRA!
- DESLIGUE SEMPRE O APARELHO DA TOMADA QUANDO REALIZAR TRABALHOS DE REPARAÇÃO!



- APENAS PARA EQUIPAMENTOS COM REFRIGERANTE R600a!

- Este equipamento contém um agente refrigerante inflamável. Por isso, certifique-se de que existe boa ventilação em torno do mesmo.
- Não utilize dispositivos mecânicos quando descongelar, pois pode provocar fugas no sistema de refrigeração.
- Não utilize equipamentos eléctricos no interior do compartimento de arrumação refrigerado.
- Todos trabalhos de reparação no aparelho devem ser realizados por um técnico qualificado (EN 60335-2-89: 2010).

Desembalar e instalação

Retire a embalagem e verifique se não existem danos resultantes do transporte.

Se houver danos resultantes do transporte, tais deverão ser reportados à empresa transportadora e anotados na guia de remessa.

- Quando colocar o aparelho no interior de um edifício, certifique-se de que existe uma distância de pelo menos 50 cm atrás e por cima do aparelho.
- Certifique-se de que a entrada de ar no painel inferior não se encontra bloqueada.
- Coloque o aparelho numa posição nivelada para um funcionamento correcto. Tal é possível regulando os pés ajustáveis:

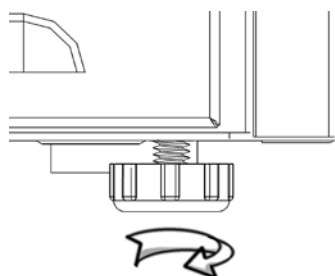

Ligações Eléctricas

Este aparelho destina-se a uma corrente eléctrica de 220-240 V/50 Hz. A ligação deve ser efectuada a uma tomada eléctrica facilmente acessível.

Este aparelho deve ter protecção adicional de acordo com as regulamentações eléctricas. O mesmo é aplicável em casos de substituição de um aparelho existente que não tenha protecção adicional.

Utilize sempre uma tomada de 3 terminais. O cabo com isolamento verde/amarelo deve ter ligação à terra (assinalado com ⊕).

Em todos os outros casos, um electricista autorizado poderá informá-lo sobre a forma como pode obter a protecção adicional do aparelho. No caso de não existir protecção adicional no edifício, a empresa fornecedora de electricidade recomenda a instalação de um interruptor PFI ou HPFI (disjuntor) realizada por um electricista.

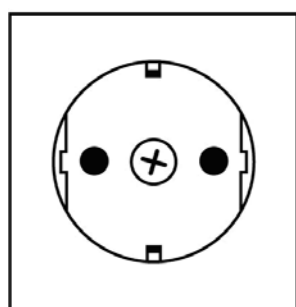

230 V_~ 50 Hz



13 A

O aparelho deve estar ligado a uma tomada protegida de 13 A.

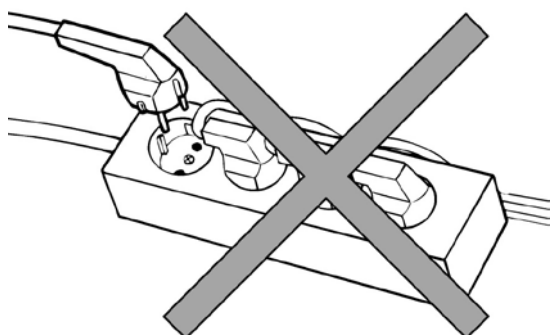

O aparelho não deve estar ligado a uma extensão com várias tomadas.

Arranque do aparelho

Antes de começar a utilizar o aparelho, é recomendável que o limpe; consulte a secção relativa à manutenção.

Importante!

Caso a arca tenha estado na posição horizontal durante o transporte, deixe-a ficar na vertical durante 2 horas antes de a ligar.

Termóstato (Ver também página 90)

A regulação do termóstato possui uma escala de 1-7, correspondendo a aproximadamente 2-12°C. Na maioria dos casos, a regulação entre 3-4 será ótima. O sistema de refrigeração pode ser desligado na posição 0.

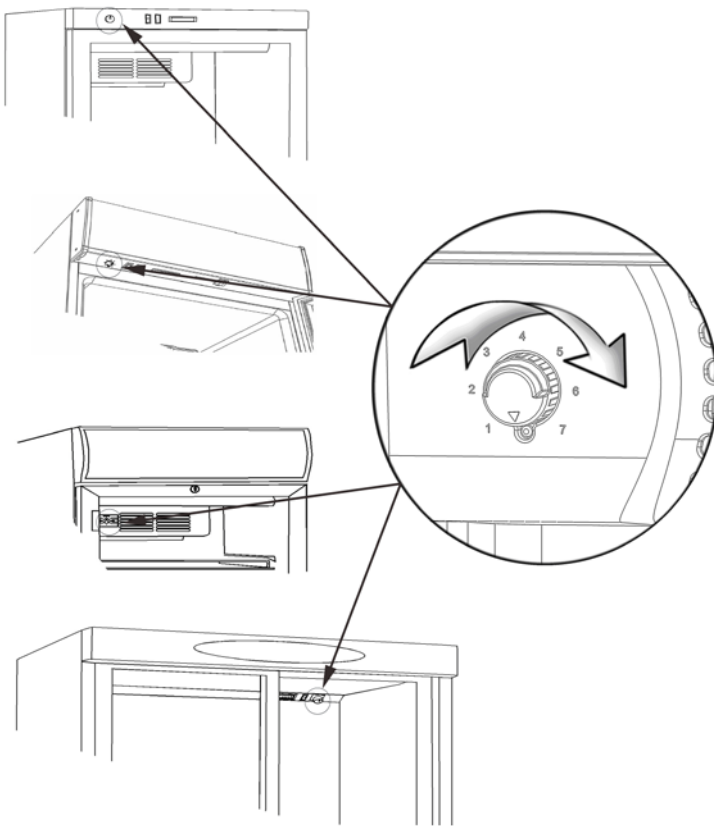

Dependendo do modelo, o termóstato pode estar colocado conforme se segue:

1. No painel superior
2. Por baixo da cobertura
3. Na cobertura da ventoinha interna

Termómetro

Todos os aparelhos estão equipados com um termómetro.

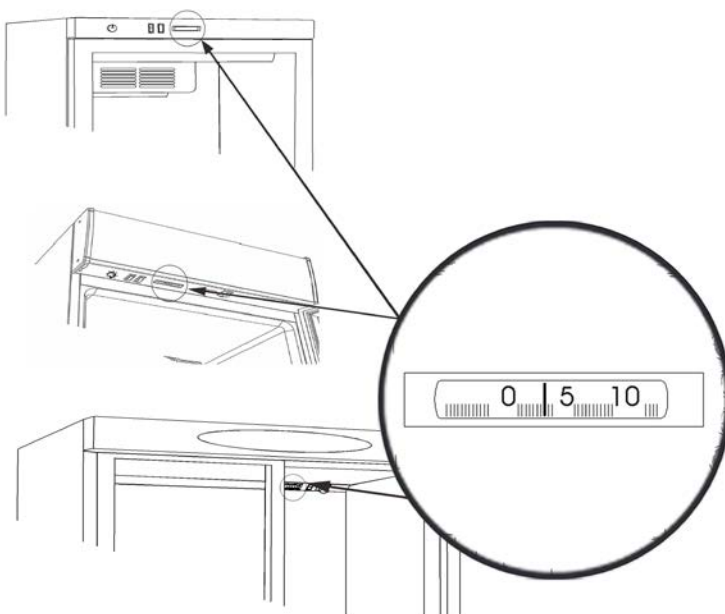

Dependendo do modelo, o termómetro pode estar colocado conforme se segue:

1. No painel superior
2. Por baixo da cobertura

Descongelo

O aparelho possui função de descongelamento automático. A água da descarga é conduzida para um tabuleiro de gotejamento, colocado no compartimento do compressor, onde é evaporada.

Bloqueio

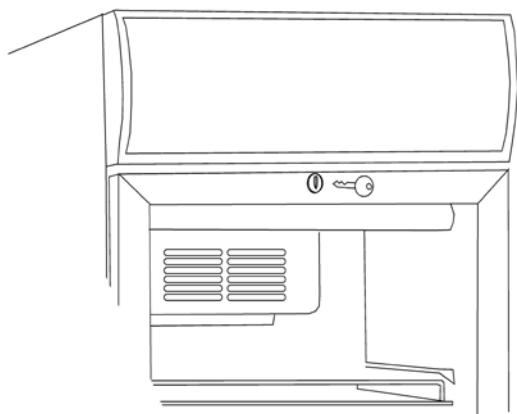

O aparelho com porta articulada possui uma fechadura. A fechadura está colocada na parte superior da porta.

Iluminação interna

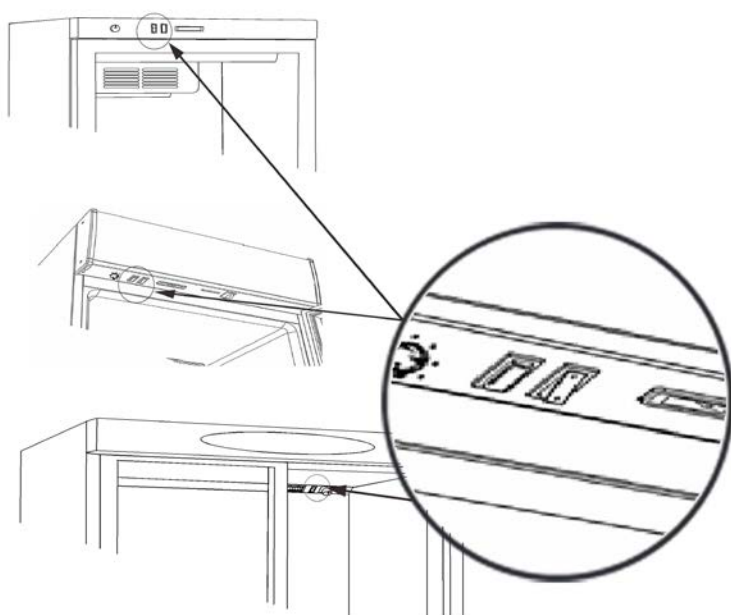

O aparelho que contenha iluminação interna possui um interruptor de luz. Dependendo do modelo, encontra-se colocada da seguinte forma:

1. No painel superior
2. Por baixo da cobertura
3. Na cobertura da ventoinha interna

Substituição da lâmpada



NÃO SE ESQUEÇA de desligar a corrente antes de proceder à substituição da lâmpada!



Iluminação interna:

É necessário desmontar a cobertura da lâmpada para proceder à substituição da lâmpada fluorescente interna. Substitua a lâmpada de formato tubular por uma de tipo equivalente.

A lâmpada LED interna deve ser substituída por uma de tipo equivalente. Contacte o seu fornecedor local para adquirir peças sobresselentes originais.

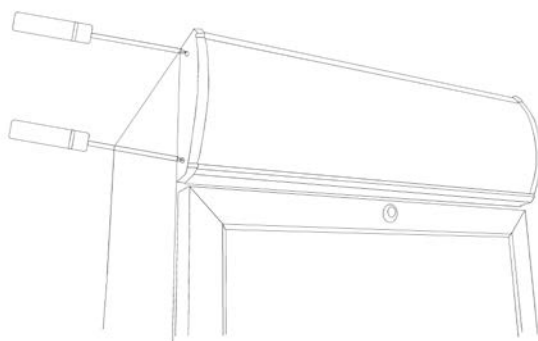

Lâmpada da cobertura:

A substituição da lâmpada fluorescente externa na cobertura é efectuada desmontando a parte situada na extremidade da cobertura. Puxe a placa da cobertura para um lado, de modo a poder aceder à lâmpada fluorescente. Substitua-a por uma de tipo equivalente.

A lâmpada LED externa da cobertura substitui-se do mesmo modo.

Contacte o seu fornecedor local para adquirir peças sobresselentes originais!

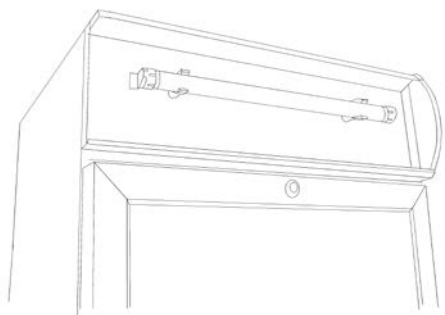

Empurre cuidadosamente a placa da cobertura para o devido lugar e monte novamente a parte situada na extremidade da cobertura.

Inversão de abertura da porta

Alguns modelos possuem portas reversíveis. Siga as instruções indicadas abaixo para proceder à inversão de abertura da porta, da direita para a esquerda e vice-versa.

Esta operação é facilmente realizada colocando cuidadosamente a arca na posição horizontal com a parte de trás voltada assente no solo ou num carro de armazém.

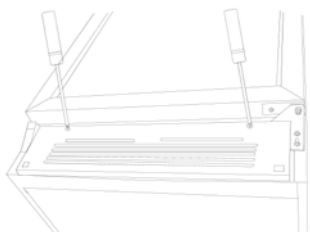

1. Remova o painel inferior.

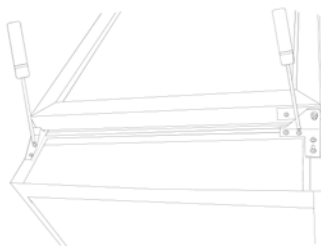

2. Remova a dobradiça superior e o acessório de suporte.

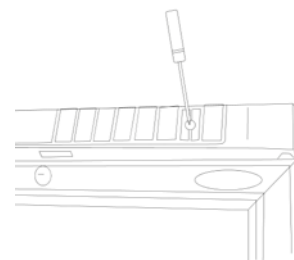

3. Remova o painel superior/cobertura.

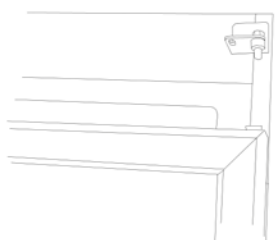

4. Levante a porta e puxe-a aproximadamente 10 cm para baixo.

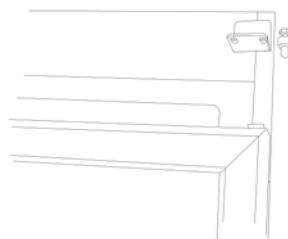

5. Remova a cavilha da dobradiça superior.

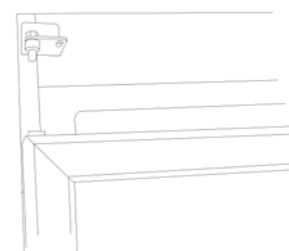

6. Coloque a cavilha da dobradiça no lado oposto sem o apertar.

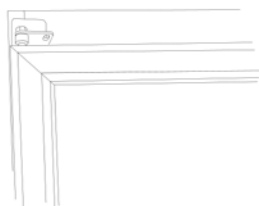

7. Levante a porta e coloque-a na dobradiça superior.



8. Aperte a cavilha da dobradiça superior.



9. Remova a cavilha da dobradiça inferior e gire a dobradiça inferior em 90 graus.

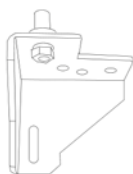

10. Coloque novamente a cavilha da dobradiça inferior na dobradiça inferior que foi rodada.

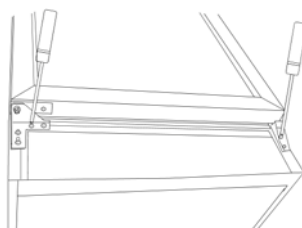

11. Coloque a dobradiça inferior no lado contrário.

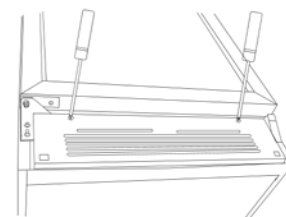

12. Coloque o acessório de suporte no lado contrário.

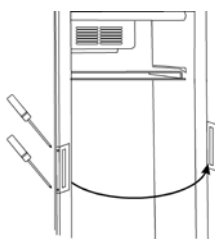

13. Desloque a pega para o lado da dobradiça do lado contrário.

Montagem na parede

Alguns modelos são preparados para montagem na parede. Consulte o quadro abaixo.

	A	Carga máx.:
FS60CP	345	20 kgs.
FS80CP	360	30 kgs.
FSC100	527	30 kgs.

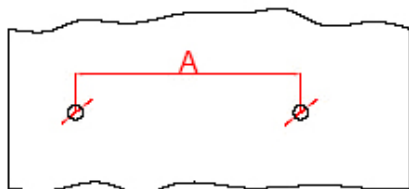

Faça dois furos com 8 mm de diâmetro e uma profundidade de 40 mm a uma distância conforme a ilustração (A).

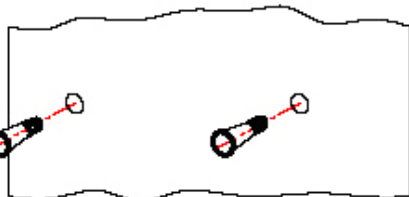

Instale buchas de 8 mm.

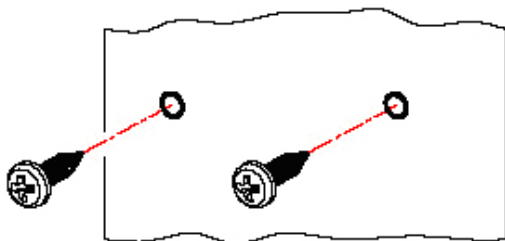

Utilize parafusos 4,8 x 38 mm, DIN Nº 7981.

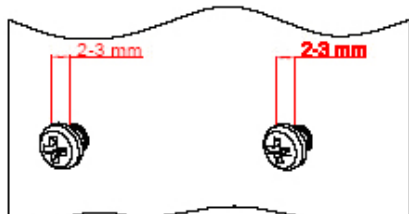

Certifique-se de que a distância entre a cabeça do parafuso e a parede é de 2-3 mm.



Certifique-se de que os parafusos se ajustam correctamente aos furos efectuados na parede.

Manutenção

O aparelho possui um sistema de arrefecimento fechado, que normalmente não necessita de qualquer manutenção.



NÃO SE ESQUEÇA de desligar a corrente antes de proceder à limpeza do aparelho!

No entanto, recomenda-se que limpe o condensador 2-4 vezes por ano com uma escova ou um aspirador. Tal pode influenciar o consumo de energia e o período de vida útil da arca.

O aparelho possui função de descongelamento automático. A água da descarga é conduzida para um tabuleiro de gotejamento, colocado no compartimento do compressor, onde é evaporada.

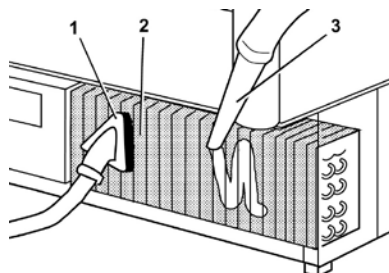
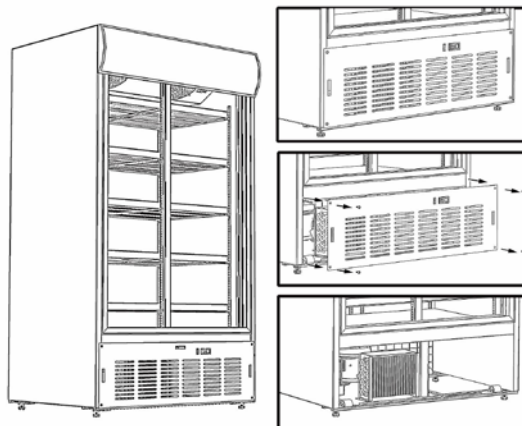
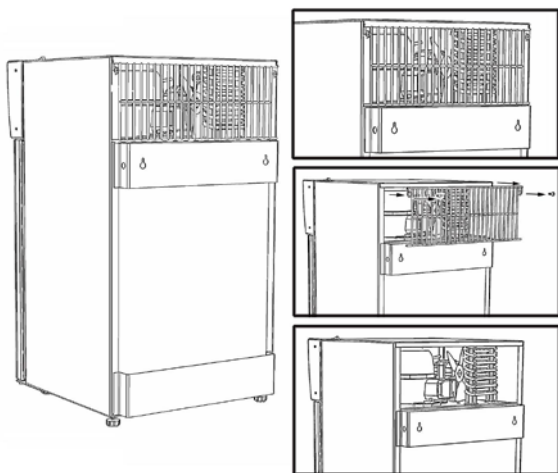
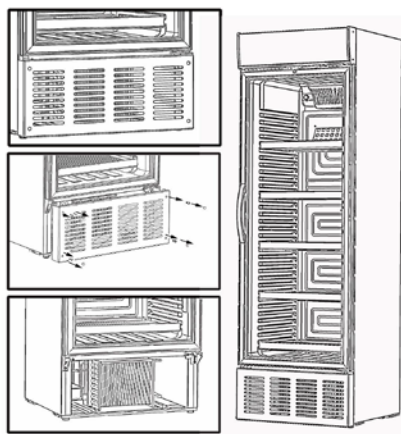
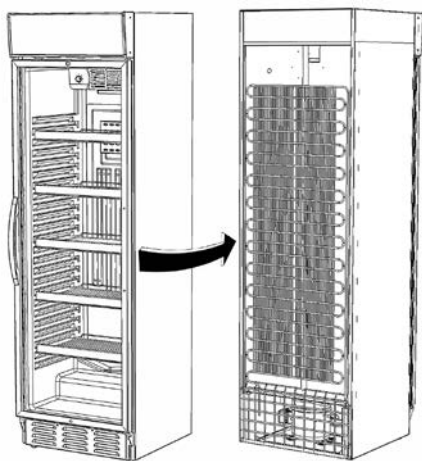

Assistência Técnica

No caso de falha da refrigeração, verifique se existe algum problema de alimentação eléctrica.

Caso não encontre nenhuma falha, contacte o seu distribuidor.

Será necessário informar o seu distribuidor sobre o número do modelo e o número de série indicados na etiqueta de características colocada, habitualmente no interior no lado direito da arca.

Recorra sempre a técnicos autorizados e a peças sobresselentes originais.



Este dispositivo cumpre as seguintes directivas europeias:

98/37/CE

89/336/CEE

73/23/CEE

Eliminação

A eliminação de aparelhos antigos deve ser efectuada correctamente a fim de proteger o ambiente. Cumpra os regulamentos nacionais relativos à eliminação de aparelhos antigos.



Technical data

Model	Temp. Range	Voltage (V)	Freq (Hz)	Net Vol. (lt)	Gross Vol. (lt)	Width Ext./Ext With pack. (mm)	Depth Ext./Ext With pack. (mm)	Height Ext./Ext With pack. (mm)	Net Weight (kg)	Gross Weight (kg)	GWP	Refrigerant	Max Load of Shelf (kg)
FS60CP	+1 / +10	230	50	45	57	455/530	480/540	720/840	32,5	37	1300	R134a	20
FS60CP R600	+1 / +10	230	50	45	57	455/530	480/540	720/840	32,5	37	3	R600a	20
FS80CP	+1 / +10	230	50	55	84	480/560	515/590	840/960	37,5	43	1300	R134a	20
FS80CP R600	+1 / +10	230	50	55	84	480/561	515/590	840/960	37,5	43	3	R600a	20
FSC100	+1 / +10	230	50	60	100	650/740	405/460	940/1050	45,5	51	1300	R134a	20
FS1220	+1 / +10	230	50	190	215	595/680	640/710	1310/1410	56,3	64,4	1300	R134a	35
SCU1220	+1 / +10	230	50	190	215	595/680	640/710	1310/1410	56,3	64,4	1300	R134a	35
FSC1220	+1 / +10	230	50	190	215	595/680	640/710	1450/1550	62,5	71,4	1300	R134a	35
SCU1220CP	+1 / +10	230	50	190	215	595/680	640/710	1450/1550	62,5	71,4	1300	R134a	35
FS1280	+1 / +10	230	50	260	290	595/680	640/710	1640/1740	70	79,3	1300	R134a	35
SCU1280	+1 / +10	230	50	260	290	595/680	640/710	1640/1740	70	79,3	1300	R134a	35
MSU300	+1 / +10	230	50	260	290	595/680	640/710	1640/1740	70	79,3	3	R600a	35
FSC1280	+1 / +10	230	50	260	290	595/680	640/710	1780/1880	74	83,3	1300	R134a	35
SCU1280CP	+1 / +10	230	50	260	290	595/680	640/710	1780/1880	74	83,3	1300	R134a	35
FS1380	+1 / +10	230	50	345	372	595/680	640/710	1840/1940	75,5	84,9	1300	R134a	35
GBC375	+1 / +10	230	50	345	372	595/680	640/710	1840/1940	75,5	84,9	3	R600a	35
SD1380	+1 / +10	230	50	345	372	595/680	640/710	1840/1940	65	73	1300	R134a	35
CEV425	+1 / +10	230	50	345	372	595/680	640/710	1840/1940	72	80	1300/3	R134a/R600a	35
SCU1375	+1 / +10	230	50	345	372	595/680	640/710	1840/1940	75,5	84,9	1300	R134a	35
MSU400	+1 / +10	230	50	345	372	595/680	640/710	1840/1940	75,5	84,9	3	R600a	35
FSC1380 R600	+1 / +10	230	50	345	372	595/680	640/710	1980/2080	80,4	90,1	3	R600a	35
SCU1375CP R600	+1 / +10	230	50	345	372	595/680	640/710	1980/2080	80,4	90,1	3	R600a	35
GBC375CP	+1 / +10	230	50	345	372	595/680	640/710	1980/2080	80,4	90,1	3	R600a	35
FSC1380	+1 / +10	230	50	345	372	595/680	640/710	1980/2080	80,4	90,1	1300	R134a	35
CEV425CP	+1 / +10	230	50	345	372	595/680	640/710	1980/2080	75	83	3/1300	R600a/R134a	35
SCU1375CP	+1 / +10	230	50	345	372	595/680	640/710	1980/2080	80,4	90,1	1300	R134a	35
FSC1450	+1 / +10	230	50	374	438	680/735	650/720	2107/2207	97	105	1300	R134a	55
SCU1450CP	+1 / +10	230	50	374	438	680/735	650/720	2107/2207	97	105	1300	R134a	55
FSC1450 R600	+1 / +10	230	50	374	438	680/735	650/720	2107/2207	97	105	3	R600a	55
SCU1450CP R600	+1 / +10	230	50	374	438	680/735	650/720	2107/2207	97	105	3	R600a	55
CPV1380M	+6 / +18	230	50	345	372	595/680	640/710	1840/1940	75,5	84,9	1300	R134a	35
CPP1380M	+6 / +18	230	50	345	372	595/680	640/710	1840/1940	75,5	84,9	1300	R134a	35
CPV425S	+6 / +18	230	50	345	372	595/680	640/710	1840/1940	75,5	84,9	1300	R134a	35
CPV425V	+6 / +18	230	50	345	372	595/680	640/710	1840/1940	75,5	84,9	1300	R134a	35
FS1002S	+1 / +10	230	50	540	730	1000/1075	735/835	1990/2170	163	176	1300	R134a	75
FS1202S	+1 / +10	230	50	660	895	1200/1275	735/835	1990/2170	174	189	1300	R134a	85
FS1500H	+1 / +10	230	50	1148	1208	1500/155	720/750	2044/2065	206,5	211,5	1300	R134a	35
FSC1950S/H	+1 / +10	230	50	710	875	1110/1185	825/925	1995/2155	175	195	1300	R134a	55
FSC1950S/H R600	+1 / +10	230	50	710	875	1110/1185	825/925	1995/2155	175	195	3	R600a	55
FSC1000S/H	+1 / +10	230	50	631	780	1000/1040	740/780	2000/2160	162	175	1300	R134a	75
FSC1000S/H R600	+1 / +10	230	50	631	780	1000/1040	740/780	2000/2160	162	175	3	R600a	75
FSC1200S/H	+1 / +10	230	50	770	960	1200/1240	740/780	2000/2160	174	188,5	1300	R134a	85
FSC1200S/H R600	+1 / +10	230	50	770	960	1200/1240	740/780	2000/2160	174	188,5	3	R600a	85

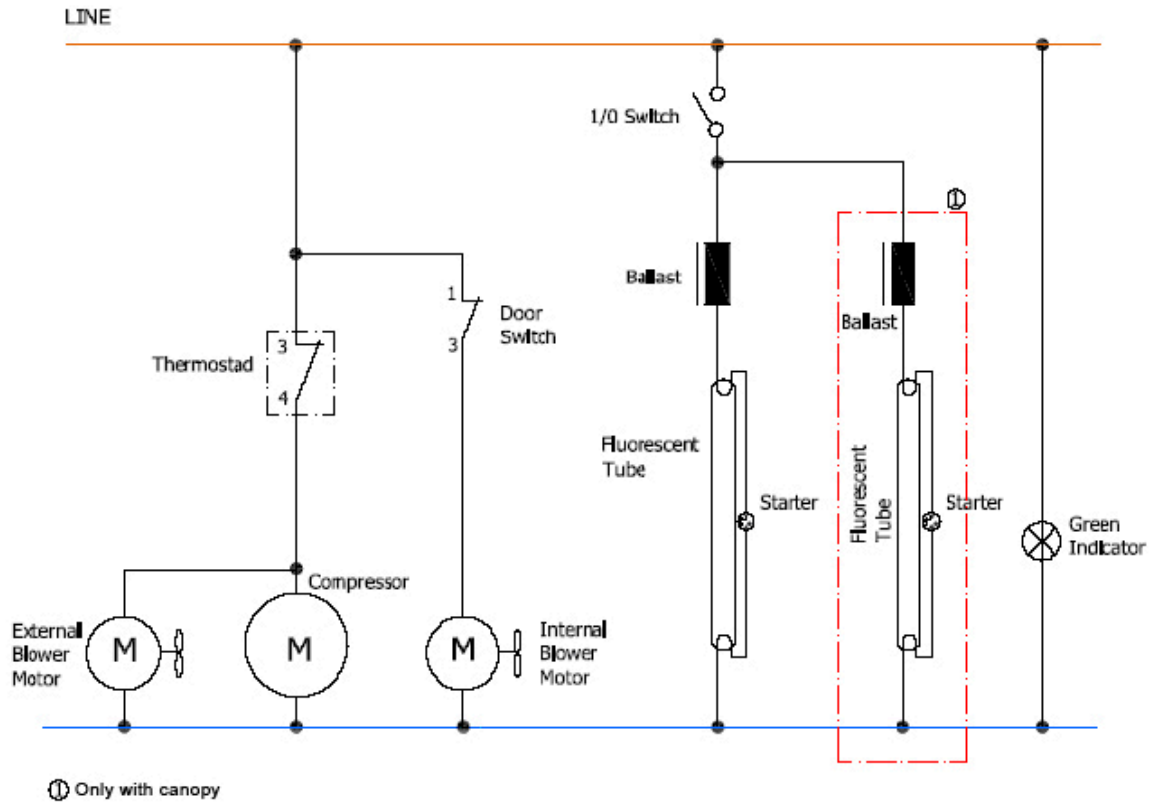

FS/FSC1220, 1280, 1450. SCU1220, 1280, 1375, 1450/CP. GBC375/CP
 CPV1380, CPP1380, CPV425S, CPV425V

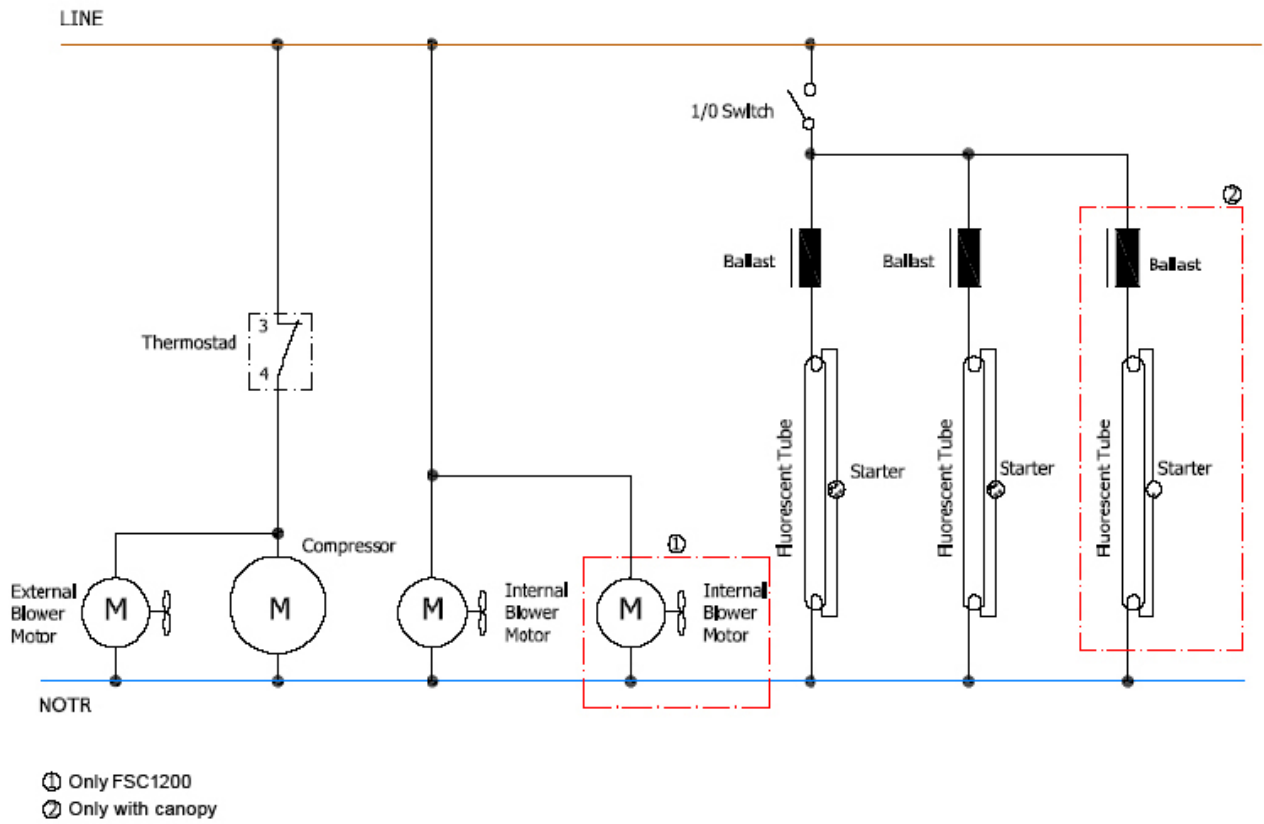

FSC1000/1200S/H, FSC1950S/H

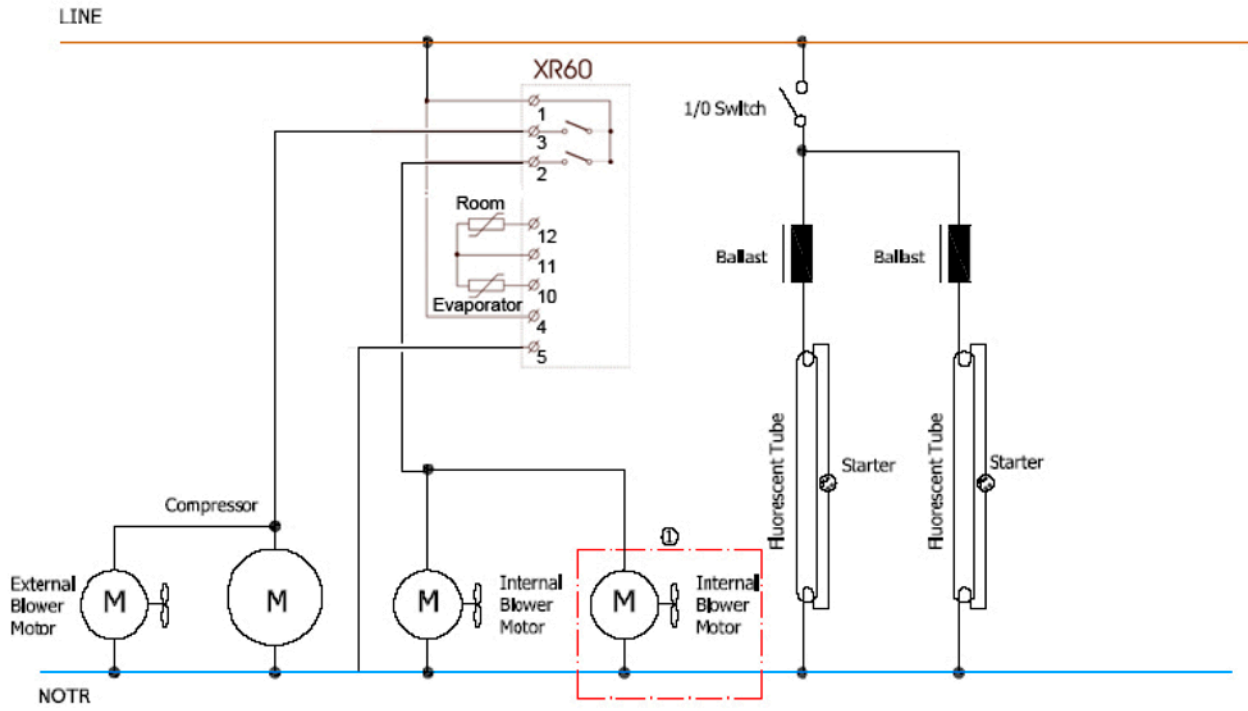

Ⓢ Only FS1202S

FS1002S/FS1202S

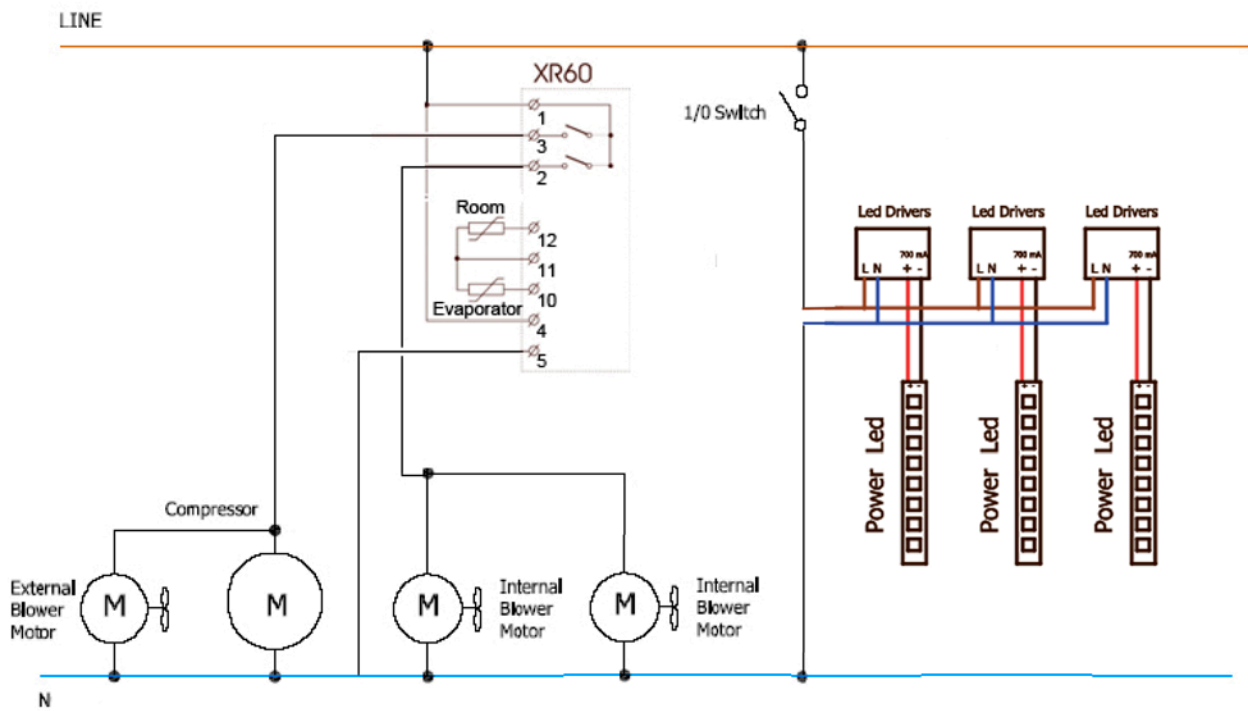

FS1500H

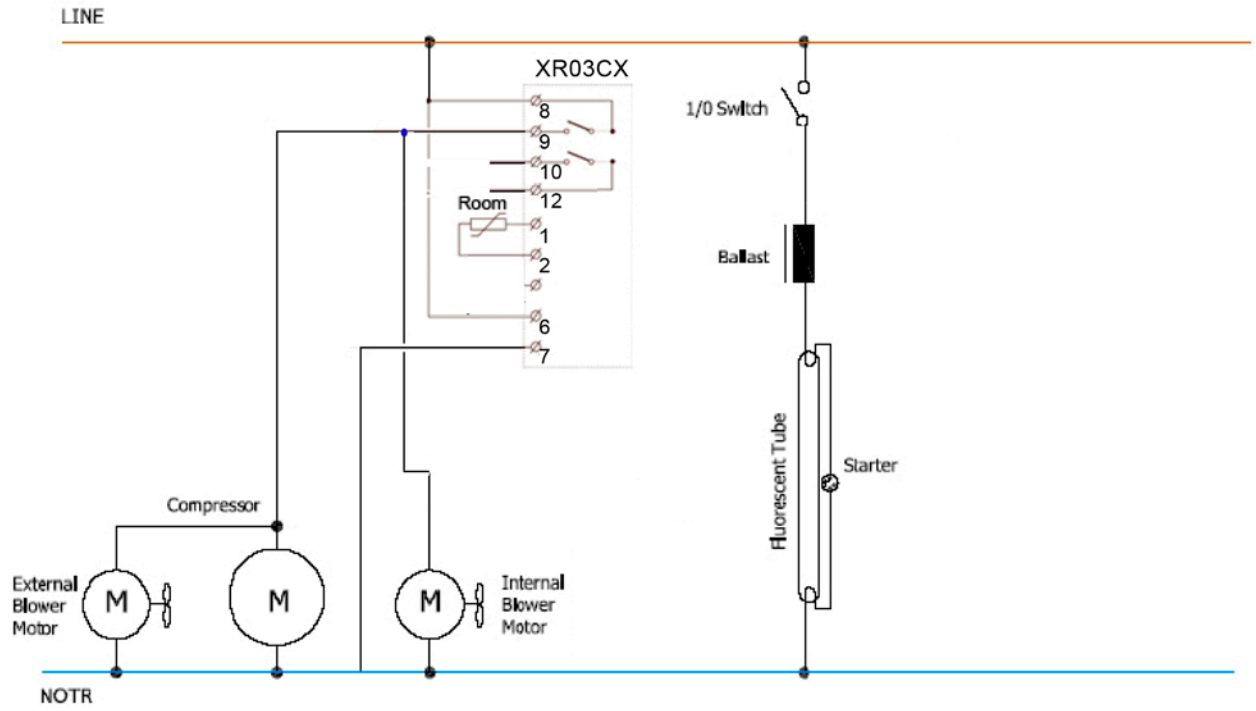

MSU300/MSU400

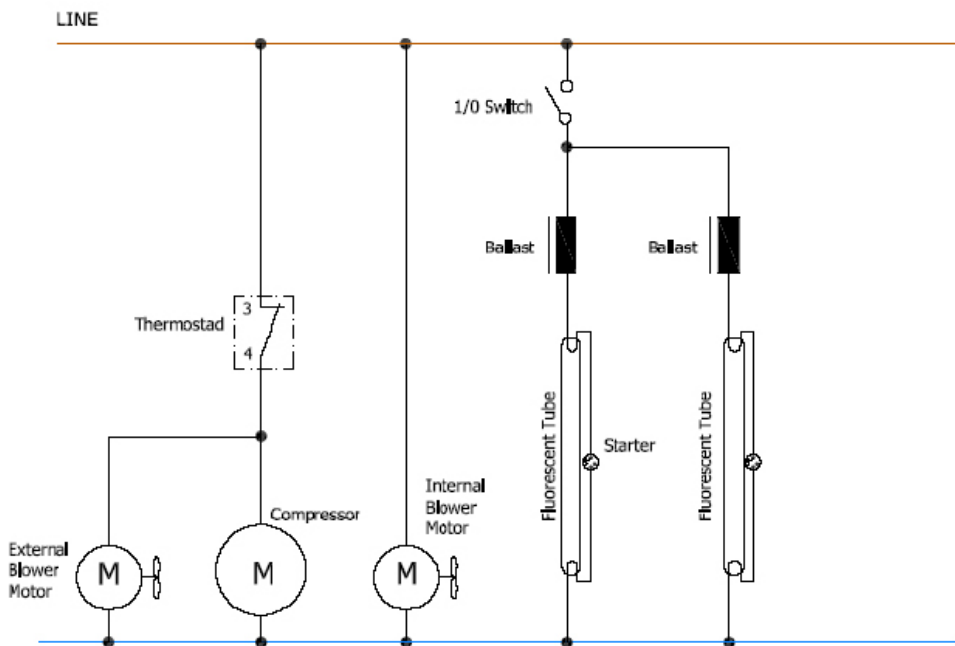

FS60CP / FS80CP / FSC100

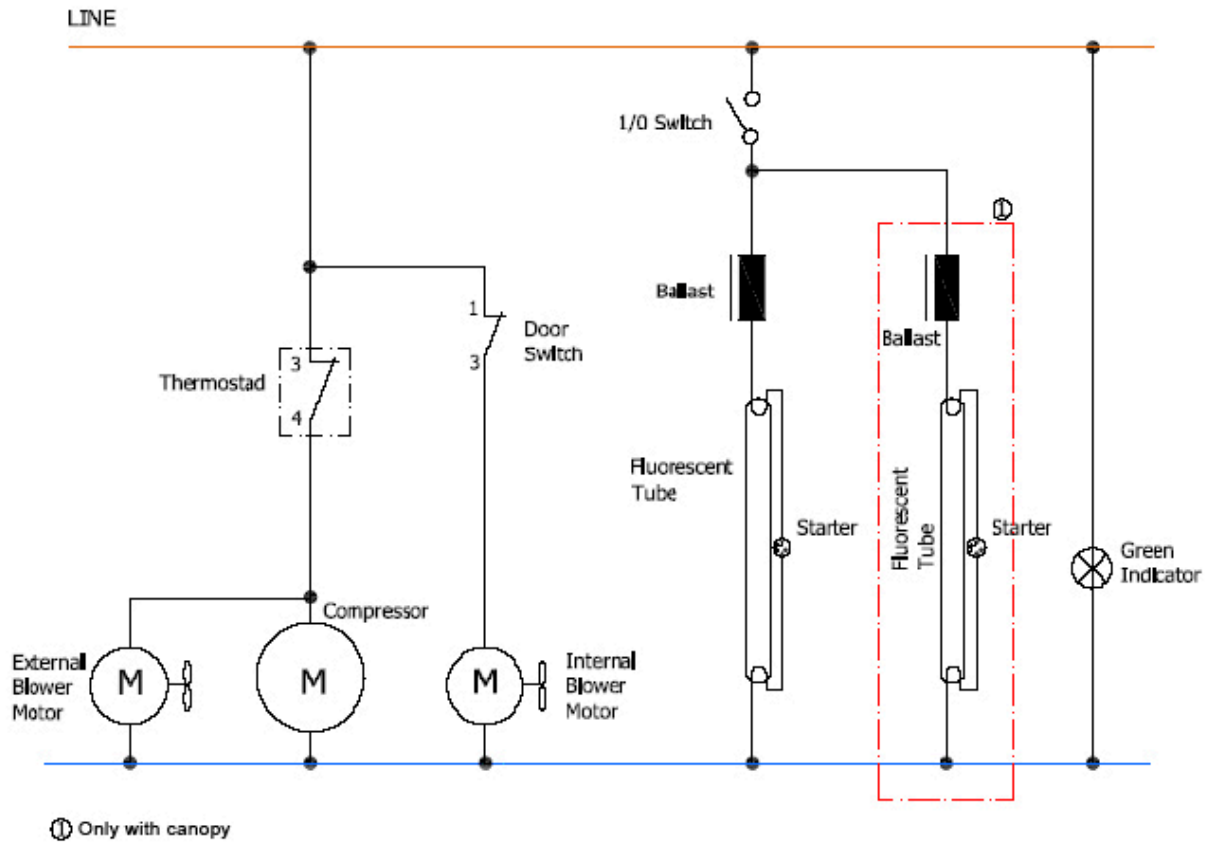

FS/FSC1220, 1280, 1450. SCU1220, 1280, 1375, 1450/CP. GBC375/CP
 CPV1380, CPP1380, CPV425S, CPV425V

For FS1002S/FS1202S:



XR60C

SET: To display target set point; in programming mode it selects a parameter or confirm an operation.

❄️ (DEF) To start a manual defrost

▲ (UP): To see the last temperature alarm happened; in programming mode it browses the parameter codes or increases the displayed value.

▼ (DOWN) To see the last temperature alarm happened; in programming mode it browses the parameter codes or decreases the displayed value.

USE OF LEDES

LED	MODE	FUNCTION
❄️	ON	Compressor enabled
❄️	Flashing	-Programming Phase (flashing with ❄️) - Anti-short cycle delay enabled
❄️	ON	Defrost enabled
❄️	Flashing	- Programming Phase (flashing with ❄️) - Drip time in progress
🌀	ON	Fans enabled
🌀	Flashing	Fans delay after defrost in progress.
🔊	ON	An temperature alarm happened

HOW TO SEE THE SETPOINT



1. Push and immediately release the **SET** key: the display will show the Set point value;
2. Push and immediately release the **SET** key or wait for 5 seconds to display the probe value again.

HOW TO CHANGE THE SETPOINT

1. Push the **SET** key for more than 2 seconds to change the Set point value;
2. The value of the set point will be displayed and the ❄️ LED starts blinking;
3. To change the Set value push the ▲ or ▼ arrows within 10s.
4. To memorise the new set point value push the **SET** key again or wait 10s.

HOW TO START A MANUAL DEFROST



Push the **DEF** key for more than 2 seconds and a manual defrost will start.

ALARM SIGNALS

Message	Cause	Outputs
"P1"	Room probe failure	Compressor output according to par. "Con" and "COF"
"P2"	Evaporator probe failure	Defrost end is timed
"HA"	Maximum temperature alarm	Outputs unchanged.
"LA"	Minimum temperature alarm	Outputs unchanged.
"dA"	Door open	Compressor and fans restarts
"EA"	External alarm	Output unchanged.
"CA"	Serious external alarm (i1F=bAL)	All outputs OFF.
"CA"	Pressure switch alarm (i1F=PAL)	All outputs OFF

**For MSU300/MSU400:
XR03CX**



SET

To display target set point, in programming mode it selects a parameter or confirm an operation



To start a manual defrost



In programming mode it browses the parameter codes or increases the displayed value



AUX

In programming mode it browses the parameter codes or decreases the displayed value

KEYS COMBINATION



To lock or unlock the keyboard

To enter in programming mode

To return to room temperature display

LED	MODO	SIGNIFICATO
	On	Compressore enabled
	Flashing	Anti short cycle delay enabled (AC parameter)
	On	Defrost in progress
	Flashing	Dripping in progress
°C	On	Measurement unit
	Flashing	Programming mode
°F	On	Measurement unit
	Flashing	Programming mode

HOW TO SEE THE SETPOINT



1. Push and immediately release the **SET** key: the display will show the Set point value;
2. Push and immediately release the **SET** key or wait for 5 seconds to display the probe value again.

HOW TO CHANGE THE SETPOINT

1. Push the **SET** key for more than 2 seconds to change the Set point value;
2. The value of the set point will be displayed and the ❄️ LED starts blinking;
3. To change the Set value push the ▲ or ▼ arrows within 10s.
4. To memorise the new set point value push the **SET** key again or wait 10s.

HOW TO START A MANUAL DEFROST



Push the **DEF** key for more than 2 seconds and a manual defrost will start.

12. ALARM SIGNALLING

Mess.	Cause	Outputs
"P1"	Room probe failure	Compressor output according to "Cy" e "Cn"
"P2"	Evaporator probe failure	Defrost end is timed (Only XR04CX)
"HA"	Maximum temperature alarm	Outputs unchanged
"LA"	Minimum temperature alarm	Outputs unchanged
"EA"	External alarm	Outputs unchanged
"CA"	Serious external alarm	All outputs OFF.
"dA"	Door Open	Compressor and fans restarts



CODE: A1304000128