











Undercounter ice maker up to 31 kg - Paddle system

Hotel	████████████████████
Restaurant	████████████████████
Fast food	████████████████████
Bar	████████████████████
Disco	████████████████████
Fish market	████████████████████
Supermarket	████████████████████
Medical & SPA	████████████████████
Industry	████████████████████

► Position n°



► Features & Plus

- Hollow cube
- AISI 304 SS Scotch Brite finish 
- Tropical class +43°C 
- Removable and cleanable air filter
- Air or water cooling system
- Easy cleanable internal rounded surfaces 
- HCFC-Free insulated storage 
- FDA approved - ABS water basin
- Basin tipping safety system
- RoHS Free 
- Disappearing insulated door
- Electromechanical operation 
- ON-OFF rocker switch 
- Automatic water charge
- Standard voltages
- HFC free 



AISI 304 SS Scotch Brite finish



Removable and cleanable air filter



FDA approved - ABS water basin



Disappearing insulated door

► Available ice cube size

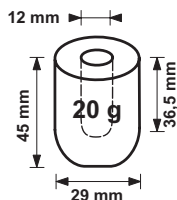

► Prod. 24h

Air temp.	Water temp.	kg	lb		
		10° C	50° F	7° C	45° F
21° C	70° F	15° C	60° F	22	49

► Certifications available for this model





Ice Finger

IMF 26 HC



Undercounter ice maker up to 31 kg - Paddle system

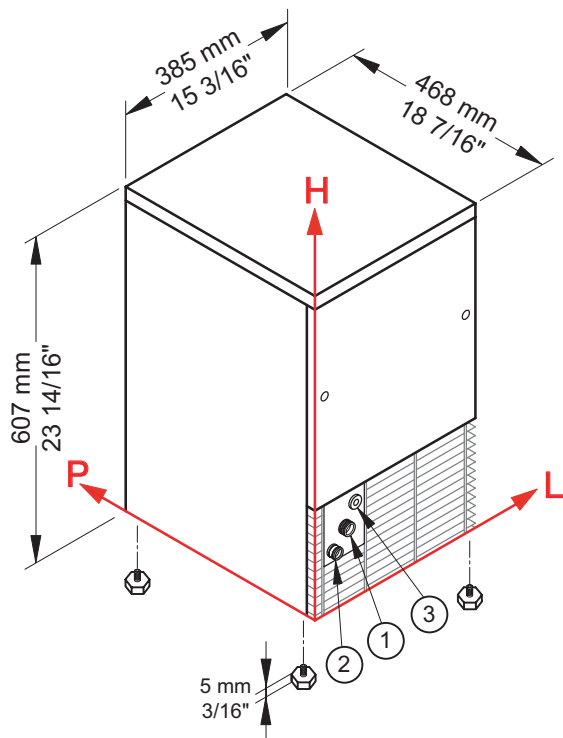

► Working conditions

- Location: **Indoor**

	Min	Max
Ambient temperature	+10° C / +50° F	+43° C / 110° F
Water temperature	+3° C / +37° F	+32° C / +90° F
Voltage	-10%	+10%
Water inlet pressure	1bar (14 psi)	6bar (84 psi)

► Performances

	Air temperature	Water temperature	Water temperature				
			7° C	45° F	15° C	60° F	21° C
	10° C	31 kg					
	50° F		68 lb				
	21° C			22 kg			
	70° F				49 lb		
	32° C					16 kg	
	90° F						35 lb

► Connections

All measures are referred to the rear bottom-left corner (L-H-Ø)

- ① Water in.: 111 mm / 4 6/16" - 175 mm / 6 14/16" - 3/4" ② Water out.: 49 mm / 1 15/16" - 130 mm / 5 2/16" - 24 mm / 15/16"
 ③ Electrical connections: 156 mm / 6 2/16" - 211 mm / 8 5/16"

► Technical information

Production in 24h	22 kg / 49 lb	Water consumption	A: 3 l/kg - 36 gal/100 lb
Store capacity, up to	4 kg / 9 lb		W: 17 l/kg - 204 gal/100 lb
Cooling system	A - W	Sizes (L-P-H mm)	385 - 468 - 607
Kind of cube	A-20g	(L-P-H in)	15 3/16 - 18 7/16 - 23 14/16
Refrigerant	R290	Sizes with pack (L-P-H mm)	440 - 520 - 800
Standard voltage	220-240 V ~ 50 Hz	(L-P-H in)	17 5/16 - 20 8/16 - 31 8/16
Average power consumption	300 W	Net weight	36 kg / 79 lb
Fuse	10 A	Gross weight	42 kg / 93 lb
Electrical consumption	31 kWh/100kg	Finish	AISI 304 stainless steel, scotch brite

All the technical information must be considered at the following conditions:

- Sizes without feet
- Standard Cube (20 g)
- Ambient temperature +21° C
- Water temperature +15° C
- Electrical consumption at +32° C (standard voltage)
- Average power consumption at +43° C (standard voltage)

Models and specifications are subject to change without notice

Rev. 00 - Issued February 2017



BREMA ICE MAKERS SPA

Via dell'Industria 10,
20020 Villa Cortese (MI), Italy

tel. +39 0331 434811
fax +39 0331 433833

www.bremaice.it
info@bremaice.it

Bjrn + Data
download

